



MESSMITTEL FÜR QS UND PRODUKTION

MESSWERKZEUGE MEASURING TOOLS



2021



2022

Ab 01.05.2022:
Teuerungszuschlag +3,5%
Versandkostenpauschale 6,50 EUR

QUALITY TOOLS

MESSTECHNIK

- ➊ **Messschieber** > calipers
- ➋ **Messschrauben** > micrometers
- ➌ **Messuhren** > dial gauges
- ➍ **Innen-Messgeräte** > internal measuring instruments
- ➎ **Anreißwerkzeuge, Lineale** > marking gauges, rulers
- ➏ **Winkel, Winkelmesser, Neigungsmessgeräte** > squares, protractors
- ➐ **Endmaße, Prüfstifte** > gauge blocks, pin gauges
- ➑ **Lehren, Einstellringe** > gauges, setting rings
- ➒ **Zentriergeräte, Kantentaster** > centre indicators, edge finders
- ➓ **Messtische, Stative, Schraubstöcke, Parallelunterlagen** > granite plates, dial stands, bench vices, parallel supports
- ➔ **Messzeug-Sätze** > measuring tool sets
- ➕ **Lupen, Leuchten, Mikroskope** > loupes, lamps, microscopes
- ➖ **Profilprojektoren** > profile projectors
- ➗ **Sonstige Messgeräte** > other measuring instruments
- ➘ **Zubehör, Kalibrierung, allgemeine Informationen** > accessories, calibration, general information



MESSTWERKZEUGE

MEASURING TOOLS



2021



2022



ISO 9001
Zertifiziertes Qualitätsmanagementsystem
www.tuev-sued.de/ms-zert



QUALITY-TOOLS MESSTECHNIK

Seit über 18 Jahren sind wir der richtige Ansprechpartner, wenn es um Längenmesstechnik geht: Vom einfachen Standard-Messschieber bis zum hochpräzisen Messmikroskop, von der Lehre bis zur Lupe und vom Prüfstift bis zum automatischen Messprojektor reicht unsere Produktpalette.

For more than 18 years we are the right partner for everything about dimension measurement. Our products range from simple calipers to high-precision measuring microscopes, from gauges to loupes and from pin gauges to automatic measuring projectors.

In unserem neuen Katalog finden Sie wieder **zahlreiche Neuheiten** in fast allen Kapiteln! Darüber hinaus konnten wir unser Lager erneut vergrößern und können nun noch mehr Messmittel **für eine kurzfristige Auslieferung** für Sie bereithalten. Und unsere **stets günstigen Preise** werden Sie auch weiterhin überzeugen...

Bestellungen nehmen wir über alle üblichen Wege (telefonisch, per Fax oder e-mail) entgegen oder Sie bestellen bequem im **Online-Shop** (www.quality-tools.de) mit immer aktueller Verfügbarkeitsanzeige!

Alle Messmittel können Sie auch kalibriert erwerben (die Kalibrierung erfolgt durch ein unabhängiges, nach **DIN EN ISO 17025** akkreditiertes Labor), auf Wunsch auch mit **DAkks**-Zertifikat.

Außerdem sind wir zertifiziert nach **DIN EN ISO 9001:2015!**



Wenn Sie unsere Produkte live testen möchten, laden wir Sie gern in unser **Vorführzentrum** am Firmensitz ein. Wir bitten um telefonische Terminvereinbarung!

Und für **Anfragen, Beratung, Service und Bestellung** stehen wir natürlich weiterhin gerne persönlich zur Verfügung...

Ihr Team von **QUALITY-TOOLS MESSTECHNIK e. K.**



Our new catalogue contains again several innovations in almost all chapters! Furthermore we could again increase our stock capacity to ensure rapid dispatch of even more measuring tools than before. And our always fair prices will continue to convince you...

Orders are welcome through all common ways (by phone, fax or e-mail) or via online shop (www.quality-tools.de) with up-to-date availability check!

All of our measuring tools can optionally be bought with a calibration certificate (the calibration is executed through an independent laboratory which is accredited by DIN EN ISO 17025), on demand also with a "DAkks" certificate.

Besides we are certified according to DIN EN ISO 9001:2015!

For testing our products live, we invite you to our show room near Stuttgart, Germany. Scheduling of appointments please in advance!

And for requests, consulting, service and ordering we are furthermore available personally...

Your team from **QUALITY-TOOLS MESSTECHNIK e. K.**

Messschieber

Calipers



Inhalt Contents



01.2



01.8



01.11



01.31



01.36

Normen Standards

Alle unsere Messschieber nach DIN 862 erfüllen folgende Werte:
All our calipers according to DIN 862 comply with following values:

zu messende Länge (mm) length to be measured (mm)	100	150	200	300	500	1000	2000
Genauigkeit* bei Ablesung 0,05 mm Accuracy at reading 0.05 mm	±0,05	±0,05	±0,05	±0,05	±0,07	±0,12	±0,22
Genauigkeit* bei Auflösung 0,01 mm Accuracy at reading 0.01 mm	±0,02	±0,03	±0,03	±0,03	±0,03	±0,04	-

*Fehlergrenze G in mm

Weitere Informationen: siehe DIN 862 (DIN Deutsches Institut für Normung e. V., erschienen im Beuth Verlag)
Further information: see DIN 862 (DIN Deutsches Institut für Normung e. V., published by Beuth Verlag)

Kalibrierung Calibration

Informationen zur Kalibrierung erhalten Sie in Kapitel 15!
Information about calibration can be found in chapter 15!

Messschieber Calipers

Messschieber mit Feststellschraube Vernier caliper with set screw

Ablesung 0,05 mm / $\frac{1}{128}$ inch | DIN 862 | rostfreier Stahl | Ableseteile mattverchromt | Gewindetabelle | Kunstledertasche
 Reading 0.05 mm / $\frac{1}{128}$ inch | DIN 862 | stainless steel | satin chrome finished | screw table | synthetic leather bag



Art.-Nr. Order no.	Messbereich Range	Schnabellänge Length of jaws	Tiefenmaß Depth gauge	EUR
10-000	70 mm	20 mm	Standard	17,80
10-001	100 mm	30 mm	Standard	17,40
10-002	150 mm	40 mm	Standard	16,90
10-004			rund round Ø2,0 mm	19,80
10-003	200 mm	50 mm	Standard	27,50
10-005	300 mm	60 mm	Standard	48,00

Messschieber mit Momentverstellung Vernier caliper with auto lock

Ablesung 0,05 mm / $\frac{1}{128}$ inch | DIN 862 | rostfreier Stahl | Ableseteile mattverchromt | Gewindetabelle | Kunstledertasche
 Reading 0.05 mm / $\frac{1}{128}$ inch | DIN 862 | stainless steel | satin chrome finished | screw table | synthetic leather bag



Art.-Nr. Order no.	Messbereich Range	Schnabellänge Length of jaws	EUR
10-011	150 mm	40 mm	16,90
10-012	200 mm	50 mm	27,50
10-013	300 mm	60 mm	48,00

Messschieber für Linkshänder Vernier caliper for left hand use

Ablesung 0,05 mm / $\frac{1}{128}$ inch | DIN 862 | rostfreier Stahl | Ableseteile mattverchromt | Gewindetabelle | Kunstledertasche
 Reading 0.05 mm / $\frac{1}{128}$ inch | DIN 862 | stainless steel | satin chrome finished | screw table | synthetic leather bag



Art.-Nr. Order no.	Messbereich Range	Schnabellänge Length of jaws	EUR
10-002L	150 mm	40 mm	26,50

Messschieber mit parallaxfreier Ablesung Vernier caliper parallax-free

Ablesung 0,05 mm / $\frac{1}{128}$ inch | DIN 862 | rostfreier Stahl | Ableseteile mattverchromt | Gewindetabelle | Kunstledertasche
 Reading 0.05 mm / $\frac{1}{128}$ inch | DIN 862 | stainless steel | satin chrome finished | screw table | synthetic leather bag



Art.-Nr. Order no.	Messbereich Range	Schnabellänge Length of jaws	EUR
10-009	150 mm	40 mm	27,50

Messschieber mit spitzem Schnabel Vernier caliper with pointed jaws

Ablesung 0,05 mm | DIN 862 | rostfreier Stahl | Ableseteile mattverchromt | Kunstledertasche
 Reading 0.05 mm | DIN 862 | stainless steel | satin chrome finished | synthetic leather bag



Art.-Nr. Order no.	Messbereich Range	Schnabelwinkel Angle of jaws	EUR
10-007	100 mm	15°	26,50

Messschieber Calipers

HELIOS-PREISSER Messschieber mit Feststellschraube Vernier caliper with set screw

Ablesung 0,05 mm / $1/128$ inch | DIN 862 | rostfreier Stahl | Ableseteile mattverchromt | Gewindetabelle | Kunstledertasche
Reading 0.05 mm / $1/128$ inch | DIN 862 | stainless steel | satin chrome finished | screw table | synthetic leather bag



Art.-Nr. Order no.	Messbereich Range	Schnabellänge Length of jaws	Tiefenmaß Depth gauge	EUR
46-001	150 mm	40 mm	Standard	24,90
46-002			rund <i>round</i> \varnothing 1,6 mm	26,50
46-003	200 mm	40 mm	Standard	33,50
46-004	300 mm	50 mm	Standard	49,50

HELIOS-PREISSER Messschieber 0,02 mm Vernier caliper 0.02 mm

Ablesung 0,02 mm / 0,001 inch | DIN 862 | rostfreier Stahl | Ableseteile mattverchromt | Gewindetabelle | Kunstledertasche

Reading 0.02 mm / 0.001 inch | DIN 862 | stainless steel | satin chrome finished | screw table | synthetic leather bag



Art.-Nr. Order no.	Messbereich Range	Schnabellänge Length of jaws	Tiefenmaß Depth gauge	EUR
46-006	150 mm	40 mm	Standard	24,90

HELIOS-PREISSER Messschieber mit Momentverstellung Vernier caliper with auto lock

Ablesung 0,05 mm / $1/128$ inch | DIN 862 | rostfreier Stahl | Ableseteile mattverchromt | Gewindetabelle | Kunstledertasche

Reading 0.05 mm / $1/128$ inch | DIN 862 | stainless steel | satin chrome finished | screw table | synthetic leather bag



Art.-Nr. Order no.	Messbereich Range	Schnabellänge Length of jaws	Tiefenmaß Depth gauge	EUR
46-011	150 mm	40 mm	Standard	24,90
46-012			rund <i>round</i> \varnothing 1,6 mm	26,50
46-013	200 mm	40 mm	Standard	33,50
46-014	300 mm	50 mm	Standard	49,50

HELIOS-PREISSER Messschieber „SOFT-SLIDE“ (besonders leichtgängig) Vernier caliper „SOFT-SLIDE“

Besonders leichtgängig durch doppelt geläppte Führungen | Ablesung 0,05 mm / $1/128$ inch | DIN 862 | rostfreier Stahl | Ableseteile mattverchromt | Gewindetabelle | Kunstledertasche

Extra smooth-running through double-lapped guidings | Reading 0.05 mm / $1/128$ inch | DIN 862 | stainless steel | satin chrome finished | screw table | synthetic leather bag



Art.-Nr. Order no.	Messbereich Range	Schnabellänge Length of jaws	Tiefenmaß Depth gauge	EUR
46-021	150 mm	40 mm	Standard	32,50

HELIOS-PREISSER Messschieber mit Prismenführung und parallaxfreier Ablesung Vernier caliper parallax-free with V-block

Ablesung 0,05 mm / $1/128$ inch | DIN 862 | rostfreier Stahl | Ableseteile mattverchromt | Gewindetabelle | Kunstledertasche

Reading 0.05 mm / $1/128$ inch | DIN 862 | stainless steel | satin chrome finished | screw table | synthetic leather bag



Querschnitt *cross section*

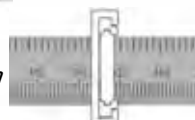

Art.-Nr. Order no.	Messbereich Range	Schnabellänge Length of jaws	Tiefenmaß Depth gauge	EUR
46-025	150 mm	40 mm	Standard	51,00

Messschieber Calipers

Uhrenmessschieber Dial caliper

Ablesung 0,01 mm | DIN 862 | rostfreier Stahl | Aufbewahrungsbox
Reading 0.01 mm | DIN 862 | stainless steel | box



Art.-Nr. Order no.	Messbereich Range	Schnabellänge Length of jaws	EUR
10-033	150 mm	40 mm	34,50
10-034	200 mm	50 mm	54,50
10-035	300 mm	60 mm	107,00

HELIOS-PREISSER Uhrenmessschieber Dial caliper

Ablesung 0,01 mm | DIN 862 | rostfreier Stahl | Aufbewahrungsbox | inkl. Hersteller-Kalibrierzertifikat
Reading 0.01 mm | DIN 862 | stainless steel | box | manufacturers calibration certificate included



Art.-Nr. Order no.	Messbereich Range	Schnabellänge Length of jaws	EUR
46-033	150 mm	40 mm	88,50

Werkstattmessschieber ohne Messerspitzen Workshop caliper without knife points

Ablesung 0,05 mm / $\frac{1}{128}$ inch | mit Feineinstellung | Genauigkeit DIN 862 (bis Schnabellänge 200 mm), Werksnorm (ab 250 mm) | Lochmaßansatz $\varnothing 10$ mm (bis 300 mm), $\varnothing 20$ mm (500 bis 1500 mm) | rostfreier Stahl | Nonius und Skala mattverchromt
Reading 0.05 mm / $\frac{1}{128}$ inch | with fine adjustment | Accuracy DIN 862 (up to length of jaws 200 mm), factory standard (≥ 250 mm) | Hole size measuring top $\varnothing 10$ mm (up to 300 mm), $\varnothing 20$ mm (500 to 1500 mm) | Stainless steel | satin chrome finished



Art.-Nr. Order no.	Messbereich Range	Schnabellänge Length of jaws	Gewicht weight	EUR
10-052	300 mm	90 mm	0,6 kg	79,50
10-053		150 mm	0,7 kg	149,00
10-054-1	500 mm	150 mm	1,6 kg	179,00
10-054-3		250 mm	1,9 kg	274,00
10-055-1	600 mm	150 mm	1,9 kg	232,00
10-055-3		300 mm	2,1 kg	375,00
10-056-1	800 mm	150 mm	2,9 kg	357,00
10-056-3		300 mm	3,5 kg	538,00
10-057-1	1000 mm	150 mm	3,3 kg	391,00
10-057-3		300 mm	3,8 kg	636,00
10-058-1	1500 mm	200 mm	7,8 kg	893,00
10-058-2		300 mm	8,2 kg	1240,00

Werkstattmessschieber mit Messerspitzen Workshop caliper with knife points

Ablesung 0,05 mm / $\frac{1}{128}$ inch | mit Feineinstellung | Genauigkeit DIN 862 (bis Schnabellänge 200 mm), Werksnorm (ab 250 mm) | Lochmaßansatz $\varnothing 10$ mm (bis 300 mm), $\varnothing 20$ mm (500 bis 3000 mm) | rostfreier Stahl | Nonius und Skala mattverchromt
Reading 0.05 mm / $\frac{1}{128}$ inch | with fine adjustment | Accuracy DIN 862 (up to length of jaws 200 mm), factory standard (from 250 mm) | Hole size measuring top $\varnothing 10$ mm (up to 300 mm), $\varnothing 20$ mm (500 to 3000 mm) | Stainless steel | satin chrome finished



Art.-Nr. Order no.	Messbereich Range	Schnabellänge Length of jaws	Gewicht weight	EUR
10-062	300 mm	90 mm	0,7 kg	99,00
10-063		150 mm	0,8 kg	169,00
10-064-1	500 mm	150 mm	1,7 kg	222,00
10-064-3		250 mm	1,9 kg	318,00
10-065-1	600 mm	150 mm	2,0 kg	267,00
10-065-3		300 mm	2,2 kg	451,00
10-066-1	800 mm	150 mm	3,0 kg	419,00
10-066-3		300 mm	3,6 kg	640,00
10-067-1	1000 mm	150 mm	3,3 kg	483,00
10-067-3		300 mm	3,9 kg	795,00
10-068-1	1500 mm	200 mm	7,9 kg	1088,00
10-068-2		300 mm	8,3 kg	1394,00
10-069-1	2000 mm	200 mm	10,0 kg	1476,00
10-069-5	3000 mm	200 mm	13,2 kg	2930,00

Messschieber Calipers

SCALA Leichtmetall-Werkstattmessschieber *Light-metal workshop caliper*

Ablesung 0,05 mm | Schieber und Schiene aus extrudiertem Aluminium-Profil mit Doppelprismenführung | Messschnäbel aus gehärtetem, rostfreiem Stahl | mit oder ohne Messerspitzen | optional mit Feineinstellung erhältlich | Lochmaßansatz Ø20 mm | Made in Germany

Reading 0.05 mm | Slide and guide rail made from extruded aluminium with V-block-guiding | jaws made from stainless hardened steel | with or without knife points | optional available with fine adjustment | Hole size measuring top Ø20 mm | Made in Germany

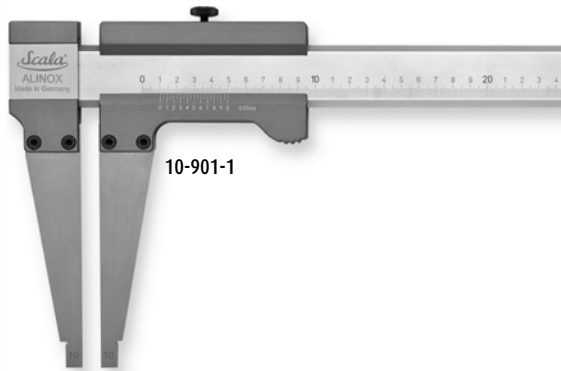

Art.-Nr. Order no.	Messbereich Range	Schnabellänge Length of jaws	Genauigkeit Accuracy	Gewicht Weight	EUR
10-901-1	500 mm	125 mm	0,07 mm	1,08 kg	528,00
10-903-1	800 mm	125 mm	0,10 mm	1,27 kg	589,00
10-904-1	1000 mm	125 mm	0,12 mm	1,42 kg	670,00
10-904-3		300 mm		1,79 kg	746,00
10-906-1	1500 mm	125 mm	0,17 mm	1,80 kg	745,00
10-907-1	2000 mm	125 mm	0,22 mm	2,17 kg	828,00
10-907-3		300 mm		2,53 kg	930,00
10-908-1	2500 mm	125 mm	0,27 mm	2,54 kg	945,00
10-909-1	3000 mm	125 mm	0,32 mm	2,91 kg	971,00
10-909-3		300 mm		3,28 kg	1044,00
10-910-1	4000 mm	125 mm	0,42 mm	3,66 kg	1246,00
10-910-3		300 mm		4,04 kg	1376,00

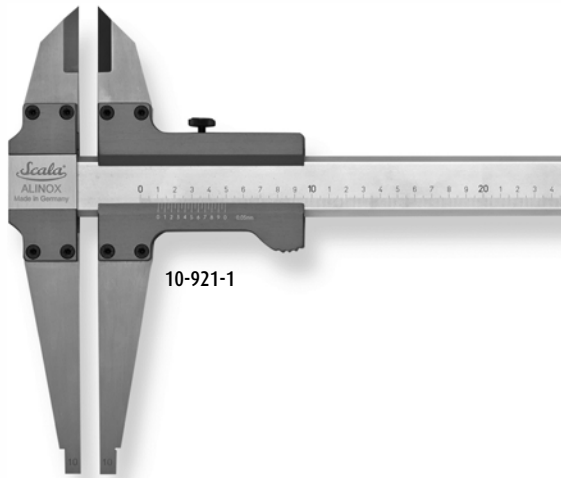

Art.-Nr. Order no.	Messbereich Range	Schnabellänge Length of jaws	Genauigkeit Accuracy	Gewicht Weight	EUR
10-921-1	500 mm	125 mm	0,07 mm	1,25 kg	963,00
10-923-1	800 mm	125 mm	0,10 mm	1,45 kg	997,00
10-924-1	1000 mm	125 mm	0,12 mm	1,60 kg	1078,00
10-924-3		300 mm		1,96 kg	1154,00
10-926-1	1500 mm	125 mm	0,17 mm	1,97 kg	1191,00
10-927-1	2000 mm	125 mm	0,22 mm	2,34 kg	1237,00
10-927-3		300 mm		2,71 kg	1339,00
10-928-1	2500 mm	125 mm	0,27 mm	2,71 kg	1352,00
10-929-1	3000 mm	125 mm	0,32 mm	3,09 kg	1428,00
10-929-3		300 mm		3,45 kg	1505,00
10-930-1	4000 mm	125 mm	0,42 mm	3,83 kg	1653,00
10-930-3		300 mm		4,19 kg	1784,00

Mehrpreis für Feineinstellung:
Additional price for fine-adjustment:

Art.-Nr. Order no.	EUR
10-949	169,00

Andere Schnabellängen auf Anfrage!
Antimagnetische Ausführung auf Anfrage!
Linkshänder-Version auf Anfrage!
Sonderanfertigungen auf Anfrage!
Other jaws on request!
Antimagnetic types on request!
Left-hander types on request!
Custom-made models on request!



Messschieber Calipers

HELIOS-PREISSER Leichtbau-Werkstattmessschieber *Workshop caliper light-metal design*

Schieber und Schiene aus harteloxiertem Aluminium | Messflächen aus gehärtetem, rostfreiem Stahl |
parallaxfreie Ablesung | leichter, gleichmäßiger Lauf durch Doppelpismenführung | Messerspitzen |
Lochmaßansatz Ø20 mm | Made in Germany | Holzetui (bis 1000 mm) / Karton (ab 1500 mm)
*Slide and guide rail made from hard anodized aluminium | jaws made from stainless hardened steel |
reading parallax-free | easy, smooth run through V-block-guiding | knife points | Hole size
measuring top Ø20 mm | Made in Germany | wooden box (up to 1000 mm) / cardboard box (from 1500 mm)*

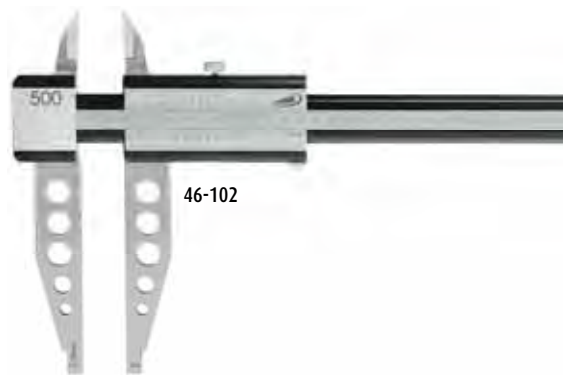

46-102

Art.-Nr. Order no.	Messbereich Range	Schnabellänge Length of jaws	Ablesung Reading	Genauigkeit Accuracy	EUR
46-101	300 mm	90 mm	0,02 mm	0,05 mm	369,00
46-102	500 mm	150 mm		0,07 mm	532,00
46-103	800 mm			0,10 mm	710,00
46-104	1000 mm			0,12 mm	🔪 829,00
46-105	1500 mm	200 mm	0,05 mm	0,17 mm	🔪 2175,00
46-106	2000 mm		0,22 mm	🔪 2495,00	

Innen-Nuten-Messschieber *Vernier caliper for inside grooves*

für Innen-Nuten ab 10 mm | Ablesung 0,05 mm | rostfreier Stahl |
Ablesesteile mattverchromt | Aufbewahrungsbox
*for inside grooves from 10 mm | Reading 0.05 mm | stainless steel |
satin chrome finished | box*

Art.-Nr. Order no.	Messbereich Range	Schnabelabmessungen Dimensions of jaws	Genauigkeit Accuracy	EUR
10-221	10-160 mm	1,7/3,0/25 mm	0,1 mm	39,50
10-222	20-160 mm	2,0/5,0/40 mm		48,50
10-223	26-200 mm	3,0/7,0/60 mm		69,50
10-224	30-250 mm	4,0/8,5/80 mm	0,15 mm	92,50
10-225	35-300 mm	5,0/10,0/100 mm		99,00

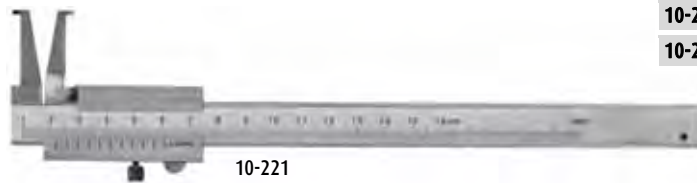

10-221

HELIOS-PREISSER Zahnweiten-Messschieber *Caliper for width of teeth*

Messbereich 0-26 mm | Ablesung 0,02 mm | Genauigkeit 0,1 mm | rostfreier Stahl | 2x Feststellschraube |
2x Feineinstellung | Holzetui
*Range 0-26 mm | reading 0.02 mm | accuracy 0.1 mm | stainless steel | 2x set screw | 2x fine adjustment |
wooden box*

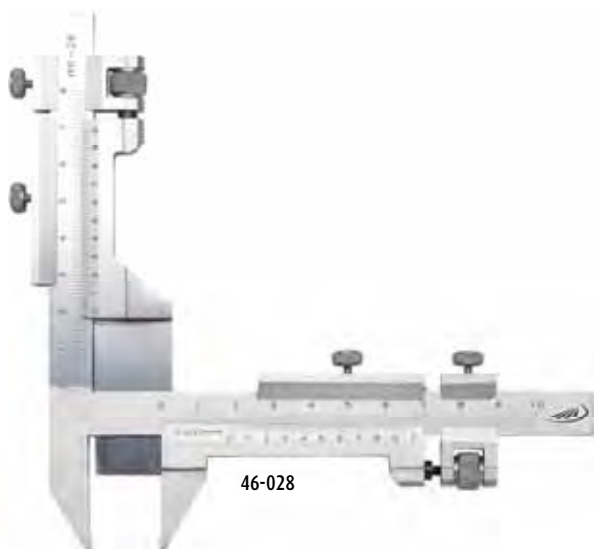

46-028

Art.-Nr. Order no.	Messflächen Measuring faces	EUR
46-028	gehärteter Stahl hardened steel	299,00
46-029	Hartmetall Carbide metal	369,00

Messschieber Calipers

3/5-Punkt-Messschieber 3- or 5-Point vernier caliper

Ablesung 0,05 mm | rostfreier Stahl | Ablese­teile mattverchromt | Kunstledertasche
Reading 0.05 mm | stainless steel | satin chrome finished | synthetic leather bag



10-201

Art.-Nr. Order no.	Messbereich Range	Punkte Points	Schnabel-Winkel Angle of jaws	EUR
10-201	4-40 mm	3	60°	49,50
10-202	2-40 mm	5	108°	58,50
10-203	20-75 mm	3	60°	97,50

HELIOS-PREISSER 3/5-Punkt-Messschieber 3- or 5-Point vernier caliper

Ablesung 0,05 mm | Genauigkeit 0,05 mm | rostfreier Stahl | Ablese­teile mattverchromt
Reading 0.05 mm | Accuracy 0.05 mm | stainless steel | satin chrome finished



Art.-Nr. Order no.	Messbereich Range	Punkte Points	Schnabel-Winkel Angle of jaws	EUR
46-036	4-40 mm	3	60°	72,50
46-037	2-40 mm	5	108°	72,50

Tiefenmessbrücke Depth measuring base

für Messschieber bis 200 mm | Schienenbreite 15,5 mm | rostfreier Stahl
for calipers up to 200 mm | width 15.5 mm | stainless steel



10-091

Art.-Nr. Order no.	Abmessungen Brücke Dimensions of base	EUR
10-091	75x6,5 mm	9,90
10-092	100x8,0 mm	13,80

HELIOS-PREISSER Tiefenmessbrücke Depth measuring base

für Messschieber bis 200 mm | Schienenbreite 16,3 mm | rostfreier Stahl
for calipers up to 200 mm | width 16.3 mm | stainless steel



Art.-Nr. Order no.	Abmessungen Brücke Dimensions of base	EUR
46-089	75x6,5 mm	21,80

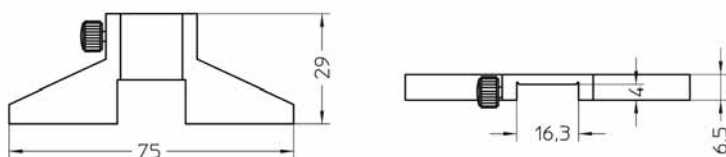

Messschieber Calipers

Tiefenmessschieber *Depth vernier caliper*

Ablesung 0,05 mm | DIN 862 | rostfreier Stahl | Ableseteile mattverchromt |
Kunstledertasche (bis 500 mm) / Aufbewahrungsbox (ab 800 mm)

*Reading 0.05 mm | DIN 862 | stainless steel | satin chrome finished |
synthetic leather bag (up to 500 mm) / box (from 800 mm)*

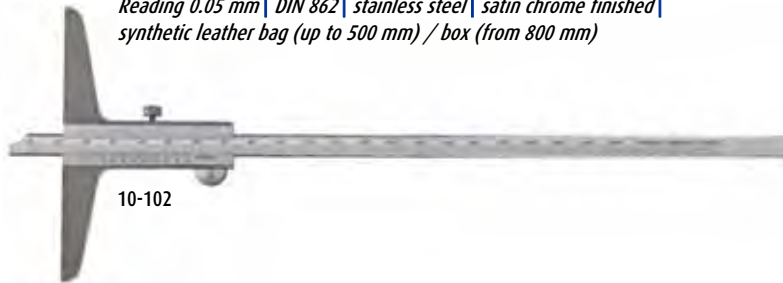

10-102

Art.-Nr. Order no.	Messbereich Range	Brückenlänge Length of base	EUR
10-101	150 mm	100 mm	19,50
10-102	200 mm		24,50
10-103	300 mm		33,50
10-104	500 mm	150 mm	76,50
10-105	800 mm	250 mm	214,00
10-106	1000 mm		286,00

Tiefenmessschieber mit rundem Messstift *Depth vernier caliper with measuring pin*

Ablesung 0,05 mm | Messstift Ø1,6 mm | DIN 862 | rostfreier Stahl | Ableseteile mattverchromt | Kunstledertasche

Reading 0.05 mm | measuring pin Ø1.6 mm | DIN 862 | stainless steel | satin chrome finished | synthetic leather bag



10-131

Art.-Nr. Order no.	Messbereich Range	Brückenlänge Length of base	EUR
10-131	80 mm	50 mm	19,90
10-132	200 mm	100 mm	33,50

HELIOS-PREISSER Klein-Tiefenmessschieber *Small depth vernier caliper*

Ablesung 0,05 mm | Messstift Ø1,0 mm | Genauigkeit 0,05 mm | rostfreier Stahl | Ableseteile mattverchromt |
wechselbarer Stift | Made in Germany | inkl. Hersteller-Kalibrierzertifikat

*Reading 0.05 mm | measuring pin Ø1.0 mm | Accuracy 0.05 mm | stainless steel | satin chrome finished |
changeable pin | Made in Germany | manufacturers calibration certificate incl.*



Art.-Nr. Order no.	Messbereich Range	Brückenlänge Length of base	EUR
46-200	80 mm	50 mm	59,50

HELIOS-PREISSER Tiefenmessschieber *Depth vernier caliper*

Ablesung 0,05 mm | DIN 862 | rostfreier Stahl | Ableseteile mattverchromt | umsteckbare Messstange
mit wechselbarem Stift | Made in Germany | inkl. Hersteller-Kalibrierzertifikat

*Reading 0.05 mm | DIN 862 | stainless steel | satin chrome finished | turnable rod with changeable pin |
Made in Germany | manufacturers calibration certificate incl.*



46-201

Art.-Nr. Order no.	Messbereich Range	Brückenlänge Length of base	Messstift Measuring pin	EUR
46-201	150 mm	100 mm	Ø1,5 mm	87,50
46-202	200 mm			91,00
46-204	300 mm	150 mm	Ø2 mm	113,00

Messschieber Calipers

HELIOS-PREISSER Tiefenmessschieber mit verschiebbarer Messbrücke *Depth vernier caliper with movable base*

Ablesung 0,02 mm | Werknorm | rostfreier Stahl | Ableseile mattverchromt | mit Messplatte und Messstift |
umsteckbare Messstange | beidseitige Skalierung | Made in Germany
*Reading 0.02 mm | factory standard | stainless steel | satin chrome finished | with measuring plate and pin |
rod turnable | scale on both sides | Made in Germany*



Art.-Nr. Order no.	Messbereich Range	Genauigkeit Accuracy	Brücke Base	Messstange Rod	Messstift Measuring pin	Messplatte Measuring plate	EUR
46-242	500 mm	0,07 mm	400x16 mm	12x4 mm	Ø2x8 mm	18x6x2 mm	735,00
46-244	1000 mm	0,12 mm	600x20 mm	20x5 mm	Ø3x8 mm	30x8x3 mm	1545,00

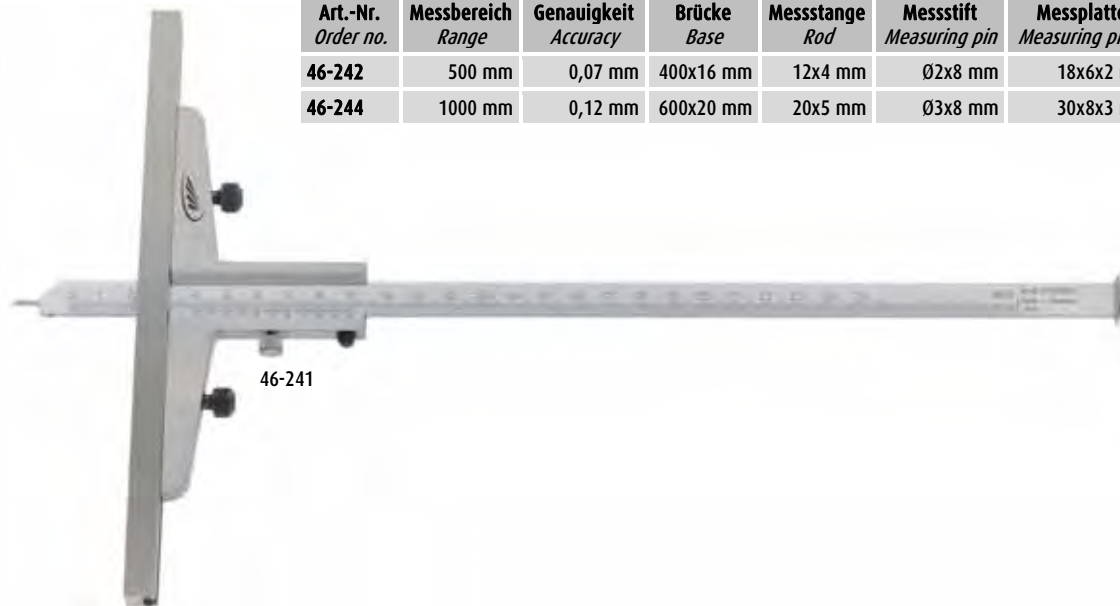

SCALA Tiefenmessschieber *Depth vernier caliper*

Ablesung 0,05 mm | Stift Ø5 mm | Schieber und Schiene aus extrudiertem Aluminium-Profil mit Doppelprismenführung |
Messbrücke aus gehärtetem, rostfreiem Stahl | optional mit Feineinstellung erhältlich | Made in Germany
*Reading 0.05 mm | pin 5 mm | Slide and guide rail made from extruded aluminium with V-block-guiding | base made from
stainless hardened steel | optional available with fine adjustment | Made in Germany*



Art.-Nr. Order no.	Messbereich Range	Brückenlänge Length of base	Genauigkeit Accuracy	Gewicht Weight	EUR
10-941-2	500 mm	200 mm	0,07 mm	1,07 kg	588,00
10-943-2	1000 mm	200 mm	0,12 mm	1,36 kg	730,00
10-943-5		500 mm	0,24 mm	2,05 kg	980,00
10-945-2	2000 mm	200 mm	0,22 mm	1,94 kg	948,00
10-945-5		500 mm	0,44 mm	2,63 kg	1199,00
10-947-2	3000 mm	200 mm	0,32 mm	2,52 kg	1329,00
10-947-5		500 mm	0,96 mm	3,21 kg	1580,00
10-948-2	4000 mm	200 mm	0,42 mm	3,10 kg	1656,00
10-948-5		500 mm	1,26 mm	3,79 kg	1907,00

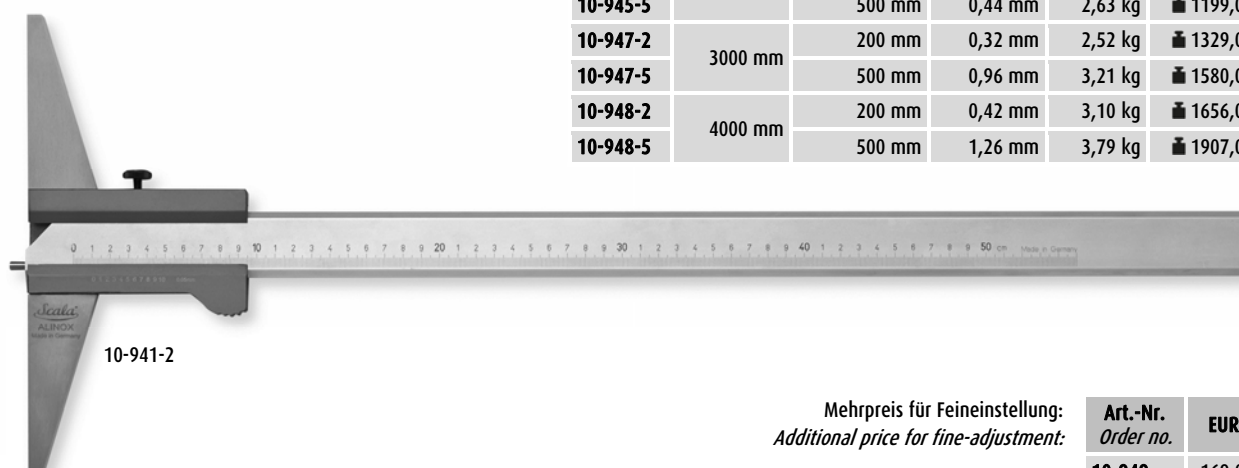

Mehrpreis für Feineinstellung:
Additional price for fine-adjustment:

Art.-Nr. Order no.	EUR
10-949	169,00

Andere Ausführungen auf Anfrage!
Other types on request!

Tiefenmessschieber mit Hakenmessstange *Depth vernier caliper with hook*

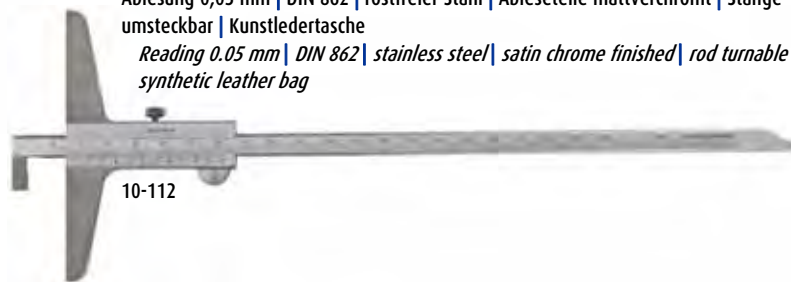

Ablesung 0,05 mm | DIN 862 | rostfreier Stahl | Ableseteile mattverchromt | Stange umsteckbar | Kunstledertasche
 Reading 0.05 mm | DIN 862 | stainless steel | satin chrome finished | rod turnable | synthetic leather bag

Art.-Nr. Order no.	Messbereich Range	Brückenlänge Length of base	EUR
10-111	150 mm	100 mm	47,50
10-112	200 mm		49,50
10-113	300 mm	150 mm	59,50
10-115	500 mm		113,00

HELIOS-PREISSER Tiefenmessschieber mit Hakenmessstange *Depth vernier caliper with hook*

Ablesung 0,05 mm | DIN 862 | rostfreier Stahl | Nonius mattverchromt | umsteckbare Messstange | beidseitige Skalierung | inkl. Hersteller-Kalibrierzertifikat
 Reading 0.05 mm | DIN 862 | stainless steel | nonius satin chrome finished | rod turnable | scale on both sides | manufacturers calibration certificate incl.



Art.-Nr. Order no.	Messbereich Range	Brückenlänge Length of base	Genauigkeit Accuracy	Messstange Rod	Haken Hook	EUR
46-211	150 mm	100 mm	0,05 mm	8x3 mm	12 mm	89,50
46-212	200 mm		0,05 mm			92,50
46-214	300 mm	150 mm	0,05 mm	12x4 mm	16 mm	113,00
46-216	500 mm		0,07 mm			179,00
46-217		250 mm	0,07 mm	20x5 mm	50 mm	382,00
46-218	800 mm		0,10 mm			512,00
46-219	1000 mm		0,12 mm			649,00

Doppelhaken-Tiefenmessschieber *Depth vernier caliper with double hook*

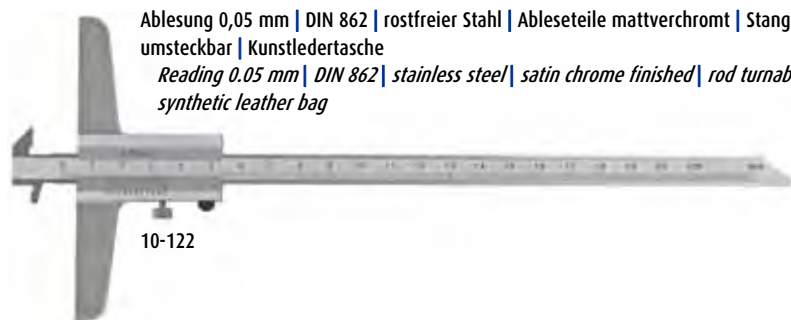

Ablesung 0,05 mm | DIN 862 | rostfreier Stahl | Ableseteile mattverchromt | Stange umsteckbar | Kunstledertasche
 Reading 0.05 mm | DIN 862 | stainless steel | satin chrome finished | rod turnable | synthetic leather bag

Art.-Nr. Order no.	Messbereich Range	Brückenlänge Length of base	EUR
10-122	200 mm	100 mm	71,50
10-123	300 mm		89,50

HELIOS-PREISSER Doppelhaken-Tiefenmessschieber *Depth vernier caliper with double hook*

Ablesung 0,05 mm | rostfreier Stahl | Ableseteile mattverchromt | umsteckbare Messstange | beidseitige Skalierung
 Reading 0.05 mm | stainless steel | satin chrome finished | rod turnable | scale on both sides

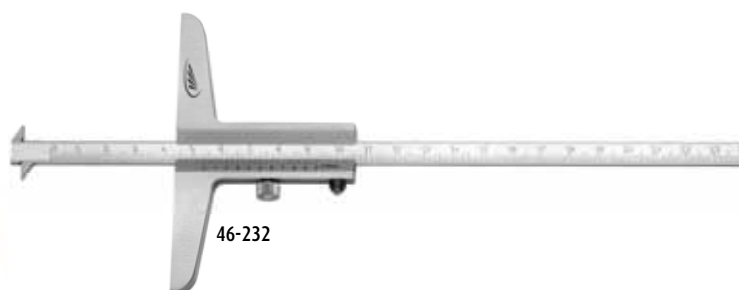

Art.-Nr. Order no.	Messbereich Range	Brückenlänge Length of base	Genauigkeit Accuracy	EUR
46-231	200 mm	100 mm	0,05 mm	86,50
46-232	300 mm			98,00

Messschieber Calipers

Digital-Messschieber *Digital caliper*

Auflösung 0,01 mm / 0,0005 inch | DIN 862 | rostfreier Stahl | Datenausgang RBS | abnehmbare Rolle | Aufbewahrungsbox
Reading 0.01 mm / 0.0005 inch | DIN 862 | stainless steel | data output RBS | removable roll | box



Art.-Nr. Order no.	Messbereich Range	Schnabellänge Length of jaws	Tiefenmaß Depth gauge	EUR
10-841	150 mm	40 mm	Standard	24,50
10-846			rund <i>round</i> Ø1,6 mm	29,50
10-842	200 mm	50 mm	Standard	46,50
10-843	300 mm	60 mm	Standard	78,50

Digital-Messschieber mit großem Display *Digital caliper with large display*

Auflösung 0,01 mm / 0,0005 inch | DIN 862 | rostfreier Stahl | großes Display (Ziffernhöhe 10 mm) | automatisches Einschalten (bei Bewegung des Messschiebers, ohne die 0-Position zu verlieren) | automatisches Ausschalten (zeitgesteuert) | Aufbewahrungsbox | inkl. Hersteller-Kalibrierzertifikat
Reading 0.01 mm / 0.0005 inch | DIN 862 | stainless steel | large display (height of digits 10 mm) | Auto-Power-On/-Off | box | manufacturers calibration certificate incl.



Art.-Nr. Order no.	Messbereich Range	Schnabellänge Length of jaws	EUR
10-811	150 mm	40 mm	28,50
10-812	200 mm	50 mm	41,50

Digital-Messschieber mit extra-großem Display *Digital caliper with extra large display*

Auflösung 0,01 mm / 0,0005 inch | DIN 862 | rostfreier Stahl | extra großes Display (Ziffernhöhe 17 mm) | Aufbewahrungsbox
Reading 0.01 mm / 0.0005 inch | DIN 862 | stainless steel | extra large display (height of digits 17 mm) | box



Art.-Nr. Order no.	Messbereich Range	Schnabellänge Length of jaws	EUR
10-890	150 mm	40 mm	36,50

Digital-Messschieber mit Metallgehäuse *Digital caliper with metal housing*

Auflösung 0,01 mm / 0,0005 inch | DIN 862 | rostfreier Stahl | Datenausgang RBS | abnehmbare Rolle | Aufbewahrungsbox
Reading 0.01 mm / 0.0005 inch | DIN 862 | stainless steel | data output RBS | removable roll | box



Art.-Nr. Order no.	Messbereich Range	Schnabellänge Length of jaws	Tiefenmaß Depth gauge	EUR
10-561	150 mm	40 mm	Standard	32,80
10-566			rund <i>round</i> Ø1,6 mm	37,50
10-562	200 mm	50 mm	Standard	62,50
10-563	300 mm	60 mm	Standard	87,50

Zubehör für Datenübertragung *Accessories for data transfer*

Für alle Messschieber mit Datenausgang RBS | am Messschieber angezeigter Messwert wird einfach per Tastendruck an einen PC (Windows 10) übertragen und direkt in ein Messprotokoll, CAQ-System, Excel-Tabelle o. ä. eingefügt | verschiedene Optionen einstellbar | Auflösung 0,01 mm
For all calipers with data output RBS | displayed value from caliper is simply transferred by keystroke to a PC (Windows 10) into a measurement report, CAQ-system or Excel table, etc. | various options adjustable | resolution 0.01 mm



Art.-Nr. Order no.	Artikel Range	EUR
10-981	USB-Interface (2,4 m)	108,00
10-991	Anschlußkabel RBS (1 m) <i>Connection cable RBS</i>	13,50

Messschieber Calipers

Digital-Messschieber mit ABS-System *Digital caliper with ABS-system*

Auflösung 0,01 mm / 0,0005 inch | DIN 862 | rostfreier Stahl | Datenausgang RBS | abnehmbare Rolle | Aufbewahrungsbox | keine Messgeschwindigkeitsbegrenzung durch ABS-System!

Reading 0.01 mm / 0.0005 inch | DIN 862 | stainless steel | data output RBS | removable roll | box | No speed limit while measuring with ABS-system!



Art.-Nr. Order no.	Messbereich Range	Schnabellänge Length of jaws	Tiefenmaß Depth gauge	EUR
10-511			Standard	39,80
10-516	150 mm	40 mm	rund Ø1,6 mm round	42,50
10-512	200 mm	50 mm	Standard	49,50
10-513	300 mm	60 mm		83,50

Digital-Präzisionsmessschieber 0,005 mm *Digital precision caliper 0.005 mm*

Auflösung 0,005 mm / 0,0002 inch | Genauigkeit 0,02 mm (30% genauer als DIN 862) | rostfreier Stahl | umschaltbar zwischen Absolut- und inkrementellem Modus | Aufbewahrungsbox

Reading 0.005 mm / 0.0002 inch | Accuracy 0.02 mm (30% more accurate than DIN 862) | stainless steel | switchable between absolute and incremental mode | box

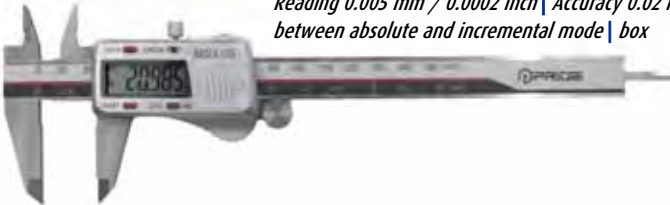

Art.-Nr. Order no.	Messbereich Range	Schnabellänge Length of jaws	EUR
10-850	150 mm	40 mm	41,50

Digital-Präzisionsmessschieber 1 µm *Digital precision caliper 1 µm*

Auflösung 0,001 mm / 0,00005 inch | Genauigkeit 0,015 mm (doppelt so genau wie DIN 862) | rostfreier Stahl | wasserdicht gemäß IP67 | Aufbewahrungsbox

Reading 0.001 mm / 0.00005 inch | Accuracy 0.015 mm (double precision as DIN 862) | stainless steel | waterproof according to IP67 | box



Art.-Nr. Order no.	Messbereich Range	Schnabellänge Length of jaws	EUR
10-860	150 mm	40 mm	123,00

Digital-Messschieber IP67 (wasser-/staubdicht) *Digital caliper IP67 (waterproof/dustproof)*

Aufl. 0,01 mm / 0,0005 inch | DIN 862 | großes Display 13 mm | Auto-Power-On/-Off | rostfr. Stahl | Aufbewahrungsbox | inkl. Hersteller-Kalibrierzertifikat

Reading 0.01 mm / 0.0005 inch | DIN 862 | large display 13 mm | Auto-Power-On/-Off | stainless steel | box | incl. manufacturers calibration certificate



Art.-Nr. Order no.	Messbereich Range	Schnabellänge Length of jaws	EUR
10-821	150 mm	40 mm	79,50
10-822	200 mm	50 mm	99,00
10-823	300 mm	60 mm	148,00

Digital-Messschieber mit grüner Toleranz-Anzeige *Digital caliper with green tolerance signal*

Auflösung 0,01 mm / 0,0005 inch | DIN 862 | rostfreier Stahl | wasserdicht gemäß IP54 | Absolut-System | grünes Leucht-Signal (LED), wenn Messwert innerhalb der eingestellten Toleranz liegt | Aufbewahrungsbox

Reading 0.01 mm / 0.0005 inch | DIN 862 | stainless steel | waterproof according to IP54 | Absolute system | green light signal (LED), if indicated value is inside the preset tolerance | box



Art.-Nr. Order no.	Messbereich Range	Schnabellänge Length of jaws	EUR
10-591	150 mm	40 mm	72,50

Messschieber Calipers

Digital-Messschieber klein *Digital caliper small*

Auflösung 0,01 mm / 0,0005 inch | DIN 862 | rostfreier Stahl | Gesamtlänge 145 mm | Aufbewahrungsbox
 Reading 0.01 mm / 0.0005 inch | DIN 862 | stainless steel | total length 145 mm | box



Art.-Nr. Order no.	Messbereich Range	Schnabellänge Length of jaws	EUR
10-050	70 mm	30 mm	32,50

Digital-Messschieber für Linkshänder *Digital caliper for left hand use*

Auflösung 0,01 mm / 0,0005 inch | DIN 862 | rostfreier Stahl | Aufbewahrungsbox
 Reading 0.01 mm / 0.0005 inch | DIN 862 | stainless steel | box



Art.-Nr. Order no.	Messbereich Range	Schnabellänge Length of jaws	EUR
10-049	150 mm	40 mm	49,00

Digital-Messschieber Anti-Magnetisch *Digital caliper non-magnetic*

Auflösung 0,01 mm / 0,0005 inch | DIN 862 | rostfreier, nicht-magnetischer Stahl | Tiefenmaß Ø3 mm | Datenausgang RB5 | Aufbewahrungsbox
 Reading 0.01 mm / 0.0005 inch | DIN 862 | stainless non-magnetic steel | Depth gauge Ø3 mm | data output RB5 | box



Art.-Nr. Order no.	Messbereich Range	Schnabellänge Length of jaws	EUR
10-847	150 mm	40 mm	86,00
10-849	300 mm	60 mm	175,00

Digital-Messschieber mit Hartmetall-Messflächen *Digital caliper with carbide measuring face*

Auflösung 0,01 mm / 0,0005 inch | DIN 862 | rostfreier Stahl | Hartmetall-Messflächen für Innen- und Außenmessung | Datenausgang RB5 | abnehmbare Rolle | Aufbewahrungsbox
 Reading 0.01 mm / 0.0005 inch | DIN 862 | stainless steel | carbide face for inside and outside measurements | data output RB5 | removable roll | box



10-047

Art.-Nr. Order no.	Messbereich Range	Schnabellänge Length of jaws	EUR
10-047	150 mm	40 mm	55,00
10-048	200 mm	50 mm	82,50

Digital-Messschieber mit Hartmetall-Messflächen IP67 (wasser-/staubdicht) *Digital caliper with carbide measuring face IP67*

Auflösung 0,01 mm / 0,0005 inch | DIN 862 | rostfreier Stahl | Sylvac-Elektronik ohne Datenausgang | Hartmetall-Messflächen für Innen-/Außenmessung | Aufbewahrungsbox
 Reading 0.01 mm / 0.0005 inch | DIN 862 | stainless steel | Sylvac-electronic without data output | carbide face for inside and outside measurements | box



Art.-Nr. Order no.	Messbereich Range	Schnabellänge Length of jaws	EUR
10-526	150 mm	40 mm	159,00

01

02

03

04

05

06

07

08

09

10

11

12

13

14

15

Messschieber Calipers

HELIOS-PREISSER Digital-Messschieber mit großem Display *Digital caliper with large display*

Messbereich 150 mm | Auflösung 0,01 mm / 0,0005 inch | DIN 862 | rostfreier Stahl | große LCD-Anzeige 11 mm | QuickStart-Elektronik (autom. Einschalten / gespeicherte 0-Position) | Aufbewahrungsbox | inkl. Hersteller-Kalibrierzert.
Range 150 mm | Reading 0.01 mm / 0.0005 inch | DIN 862 | stainless steel | large LCD-display 11 mm | Quick-Start-electronic (automatic switch on / saved position of zero) | box | manufacturers calibration certificate incl.



Art.-Nr. Order no.	Schnabellänge Length of jaws	Tiefenmaß Depth gauge	wasserdicht waterproof	EUR
46-041	40 mm	Standard	nein <i>no</i>	85,00
46-046		rund <i>round</i> Ø1,5 mm		85,00
46-047		Standard	ja <i>yes</i> (IP67)	123,00
46-048		rund <i>round</i> Ø1,5 mm		123,00

HELIOS-PREISSER Digital-Messschieber mit Datenausgang *Digital caliper with data output*

Auflösung 0,01 mm / 0,0005 inch | DIN 862 | rostfreier Stahl | variabler Datenausgang RS232 / Digimatic / USB | QuickStart-Elektronik (automatisches Einschalten / gespeicherte Nullposition) | Aufbewahrungsbox | inkl. Hersteller-Kalibrierzertifikat
Reading 0.01 mm / 0.0005 inch | DIN 862 | stainless steel | variable data output RS232 / Digimatic / USB | Quick-Start-electronic (automatic switch on / saved position of zero) | box | manufacturers calibration certificate included



Art.-Nr. Order no.	Messbereich Range	Schnabellänge Length of jaws	Tiefenmaß Depth gauge	EUR
46-051	150 mm	40 mm	Standard	142,00
46-056			rund <i>round</i> Ø1,5 mm	142,00
46-052	200 mm	50 mm	Standard	181,00
46-053	300 mm	65 mm	ohne <i>without</i>	229,00

HELIOS-PREISSER Digital-Messschieber IP67 (wasser-/staubdicht) mit Datenausgang *Digital caliper IP67 with data output*

Auflösung 0,01 mm / 0,0005 inch | DIN 862 | rostfreier Stahl | variabler Datenausgang RS232 / Digimatic / USB | QuickStart-Elektronik (automatisches Einschalten / gespeicherte Nullposition) | wasserdicht gemäß IP67 | Aufbewahrungsbox | inkl. Hersteller-Kalibrierzertifikat
Reading 0.01 mm / 0.0005 inch | DIN 862 | stainless steel | variable data output RS232 / Digimatic / USB | Quick-Start-electronic (automatic switch on / saved position of zero) | waterproof according to IP67 | box | manufacturers calibration certificate included



Art.-Nr. Order no.	Messbereich Range	Schnabellänge Length of jaws	Tiefenmaß Depth gauge	EUR
46-071	150 mm	40 mm	Standard	155,00
46-076			rund <i>round</i> Ø1,5 mm	155,00
46-072	200 mm	50 mm	Standard	229,00

HELIOS-PREISSER Datenübertragungskabel für variablen Datenausgang *Data transfer cable for variable data output*

für alle HELIOS-PREISSER Messgeräte mit variablem Datenausgang | Länge 2 m | mit Datenübertragungstaste | Software „MarCom Professional“ für Windows 7/8/10 zum Übertragen der Messwerte in Anwendungen kostenlos downloadbar auf www.helios-preisser.de
For all HELIOS-PREISSER measuring tools with variable data output | length 2 m | with data transfer button | software "MarCom Professional" for Windows 7/8/10 for transferring measuring values into applications free download at www.helios-preisser.de

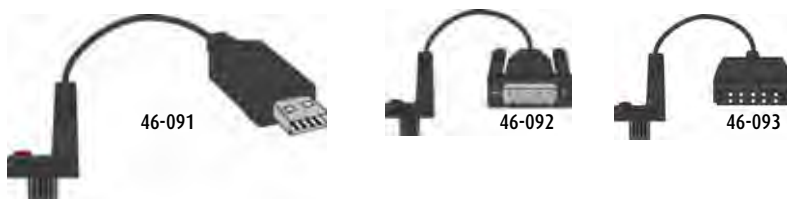

Art.-Nr. Order no.	Schnittstelle Interface	EUR
46-091	USB	69,50
46-092	RS232	49,00
46-093	Digimatic	62,50

Weitere Informationen und Zubehör zum Thema Datenübertragung finden Sie in Kapitel 15!
Further information and accessories related to data transfer can be found in chapter 15!

Messschieber Calipers

HELIOS-PREISSER Digital-Messschieber mit Funk-Datenübertragung *Digital caliper with wireless data output*

Auflösung 0,01 mm / 0,0005 inch | DIN 862 | rostfreier Stahl | großes Display 11 mm | wasserdicht gemäß IP67 | integrierter Funksender „Integrated Wireless“ | QuickStart-Elektronik (automatisches Einschalten / gespeicherte Nullposition) | Aufbewahrungsbox | inkl. Hersteller-Kalibrierzertifikat
Reading 0.01 mm / 0.0005 inch | DIN 862 | stainless steel | large display 11 mm | waterproof according to IP67 | data output with "Integrated Wireless" | Quick-Start-electronic (automatic switch on / saved position of zero) | box | manufacturers calibration certificate included



Art.-Nr. Order no.	Messbereich Range	Schnabellänge Length of jaws	Tiefenmaß Depth gauge	EUR
46-061	150 mm	40 mm	Standard	214,00
46-066			rund <i>round</i> \varnothing 1,5 mm	214,00
46-062	200 mm	50 mm	Standard	273,00
46-063	300 mm	65 mm	ohne <i>without</i>	331,00

HELIOS-PREISSER USB-Empfänger für Funk-Datenübertragung *USB receiver for wireless data transfer*

für bis zu 8 HELIOS-PREISSER Messgeräte mit „Integrated Wireless“ | Funkdistanz bis zu 6 m | USB-Anschluss | Software „MarCom Professional“ für Windows 7/8/10 zum Übertragen der Messwerte in Anwendungen kostenlos downloadbar auf www.helios-preisser.de
For up to 8 HELIOS-PREISSER measuring tools with "Integrated Wireless" | radio distance up to 6 m | USB interface | software "MarCom Professional" for Windows 7/8/10 for transferring measuring values into applications free download at www.helios-preisser.de



Art.-Nr. Order no.	EUR
46-099	93,50

Weitere Informationen und Zubehör zum Thema Datenübertragung finden Sie in Kapitel 15!
Further information and accessories related to data transfer can be found in chapter 15!

HELIOS-PREISSER Funktionserweiterungs-Set für Messschieber *Function extension set for calipers*

14tlg. Erweiterungs-Set für digitale Messschieber mit max. Schenkelstärke 3,5 mm | zum einfachen Messen von Bohrungsabständen, Nuten, Einstichen, etc. | Holzboxe
Extension set with 14 parts for digital calipers with max thickness of jaws 3.5 mm | for easy measuring of hole separation, notches, cut-ins, etc. | wooden box



Art.-Nr. Order no.	EUR
46-090	166,00

Anwendungsbeispiele *Examples of use*



Messschieber Calipers

SYLVAC Digital-Messschieber *Digital caliper*

Auflösung 0,01 mm | DIN 862 | großes Display (Ziffernhöhe 11,5 mm) | rostfreier Stahl | Absolutes System S.I.S (automatisches Einschalten durch Bewegen, gespeicherte Position) | PRESET-Funktion | HOLD-Funktion | personalisierbare Taste für wählbare Funktion | wasserdicht gemäß IP67 | Swiss made | Aufbewahrungsbox

Reading 0.01 mm | DIN 862 | large display (height of digits 11.5 mm) | stainless steel | Absolute System S.I.S (automatic power on through movement, saved position) | PRESET function | HOLD function | customizable key for selectable function | waterproof according to IP67 | Swiss made | box



Art.-Nr. Order no.	Messbereich Range	Schnabellänge Length of jaws	Tiefenmaß Depth gauge	EUR
19-011	150 mm	40 mm	Standard	116,00
19-012			rund <i>round</i> Ø1,5 mm	116,00
19-013	200 mm	50 mm	Standard	185,00
19-014	300 mm	64 mm	ohne <i>without</i>	244,00

SYLVAC Digital-Messschieber Bluetooth® Datenausgang *Digital caliper Bluetooth® data output*

Auflösung 0,01 mm | DIN 862 | großes Display (Ziffernhöhe 11,5 mm) | rostfreier Stahl | Datenausgang „Bluetooth“ (kabellos) | Absolutes System S.I.S (automatisches Einschalten durch Bewegen, gespeicherte Position) | PRESET-Funktion | HOLD-Funktion | personalisierbare Taste für wählbare Funktion | wasserdicht gemäß IP67 | Swiss made | Aufbewahrungsbox

Reading 0.01 mm | DIN 862 | large display (height of digits 11.5 mm) | stainless steel | data output "Bluetooth" (wireless) | Absolute System S.I.S (automatic power on through movement, saved position) | PRESET function | HOLD function | customizable key for selectable function | waterproof according to IP67 | Swiss made | box



Art.-Nr. Order no.	Messbereich Range	Schnabellänge Length of jaws	Tiefenmaß Depth gauge	EUR
19-016	150 mm	40 mm	Standard	198,00
19-017			rund <i>round</i> Ø1,5 mm	198,00
19-018	200 mm	50 mm	Standard	298,00
19-019	300 mm	64 mm	ohne <i>without</i>	375,00

SYLVAC Digital-Messschieber 1 µm *Digital caliper 1 µm*

Auflösung 1 µm | Genauigkeit 0,02 mm (bis 100 mm), 0,03 mm (ab 100 mm) | großes Display (Ziffernhöhe 11,5 mm) | rostfreier Stahl | Tiefenmaß eckig | Absolutes System S.I.S (automatisches Einschalten durch Bewegen, gespeicherte Position) | PRESET-Funktion | HOLD-Funktion | personalisierbare Taste für wählbare Funktion | wasserdicht gemäß IP67 | Swiss made | Aufbewahrungsbox

Reading 1 µm | Accuracy 0.02 mm (up to 100 mm), 0.03 mm (from 100 mm) | large display (height of digits 11.5 mm) | stainless steel | depth gauge rectangular | Absolute System S.I.S (automatic power on through movement, saved position) | PRESET function | HOLD function | customizable key for selectable function | waterproof according to IP67 | Swiss made | box



Art.-Nr. Order no.	Messbereich Range	Schnabellänge Length of jaws	Datenausgang Data output	EUR
19-021	150 mm	40 mm	Proximity USB/RS232 kabelgebunden <i>tethered</i>	298,00
19-023			Bluetooth <i>wireless</i> kabellos	315,00

SYLVAC USB-Dongle Bluetooth® *USB dongle Bluetooth®*



USB-Empfangseinheit für Windows 10 | für bis zu 8 SYLVAC-Messgeräte mit Bluetooth-Datenausgang | automatische Erkennung der Messgeräte | inkl. Software „Vmux“

USB receiver for Windows | for up to 8 SYLVAC measuring tools with Bluetooth data output | automatic detection of measuring tools | incl. Software "Vmux"



Art.-Nr. Order no.	EUR
19-399	79,50

Messschieber Calipers

Digital-Messschieber mit **dünnen Schnäbeln** *Digital caliper with thin jaws*

Auflösung 0,01 mm / 0,0005 inch | Schnabdiedicke 0,75 mm | Genauigkeit 0,03 mm | rostfreier Stahl | Datenausgang RB5 | Aufbewahrungsbox
Reading 0.01 mm / 0.0005 inch | thickness of jaws 0.75 mm | accuracy 0.03 mm | stainless steel | data output RB5 | box

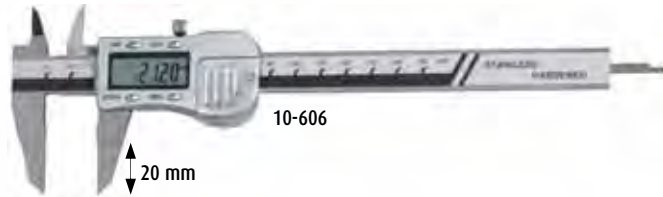

Art.-Nr. Order no.	Messbereich Range	Schnabellänge Length of jaws	EUR
10-606	150 mm	40 mm	49,50
10-607	200 mm	50 mm	66,50

HELIOS-PREISSER Digital-Messschieber mit **dünnen Schnäbeln** *Digital caliper with thin jaws*

Auflösung 0,01 mm / 0,0005 inch | Schnabdiedicke 0,5 mm | rundes Tiefenmaß Ø1,5 mm | variabler Datenausgang RS232 / Digimatic / USB | QuickStart-Elektronik (automatisches Einschalten / gespeicherte Nullposition) | wasserdicht gemäß IP67 | rostfreier Stahl | Aufbewahrungsbox

Reading 0.01 mm / 0.0005 inch | thickness of jaws 0.5 mm | round depth gauge Ø1.5 mm | variable data output RS232 / Digimatic / USB | Quick-Start-electronic (automatic switch on / saved position of zero) | waterproof according to IP67 | stainless steel | box



Art.-Nr. Order no.	Messbereich Range	Schnabellänge Length of jaws	EUR
47-021	150 mm	40 mm	534,00

Digital-Messschieber mit **spitzem Schnabel** *Digital caliper with pointed jaws*

Auflösung 0,01 mm / 0,0005 inch | Genauigkeit 0,03 mm | rostfreier Stahl | Datenausgang RB5 | Aufbewahrungsbox
Reading 0.01 mm / 0.0005 inch | accuracy 0.03 mm | stainless steel | data output RB5 | box



Art.-Nr. Order no.	Messbereich Range	Schnabelwinkel Angle of jaws	EUR
10-648	150 mm	15°	49,50

HELIOS-PREISSER Digital-Messschieber mit **spitzem Schnabel** *Digital caliper with pointed jaws*

Auflösung 0,01 mm / 0,0005 inch | rundes Tiefenmaß Ø1,5 mm | variabler Datenausgang RS232 / Digimatic / USB | QuickStart-Elektronik (automatisches Einschalten / gespeicherte Nullposition) | wasserdicht gemäß IP67 | rostfreier Stahl | Aufbewahrungsbox

Reading 0.01 mm / 0.0005 inch | round depth gauge Ø1.5 mm | variable data output RS232 / Digimatic / USB | Quick-Start-electronic (automatic switch on / saved position of zero) | waterproof according to IP67 | stainless steel | box



Art.-Nr. Order no.	Messbereich Range	Schnabelwinkel Angle of jaws	EUR
47-023	150 mm	21°	385,00

Digital-Messschieber mit **feinen Messspitzen** *Digital caliper with fine jaws*

Auflösung 0,01 mm / 0,0005 inch | Genauigkeit 0,05 mm | rostfreier Stahl | Datenausgang RB5 | Aufbewahrungsbox
Reading 0.01 mm / 0.0005 inch | accuracy 0.05 mm | stainless steel | data output RB5 | box



Art.-Nr. Order no.	Messbereich Range	Schnabel- abmessung Dimension of jaws	EUR
10-649	150 mm	10x2,5 mm	152,00

01

02

03

04

05

06

07

08

09

10

11

12

13

14

15

Messschieber Calipers

HELIOS-PREISSER Digital-Messschieber mit feinen Messspitzen *Digital caliper with fine jaws*

Auflösung 0,01 mm / 0,0005 inch | rundes Tiefenmaß Ø1,5 mm | variabler Datenausgang RS232 / Digimatic / USB | QuickStart-Elektronik (automatisches Einschalten / gespeicherte Nullposition) | wasserdicht gemäß IP67 | rostfreier Stahl | Aufbewahrungsbox

Reading 0.01 mm / 0.0005 inch | round depth gauge Ø1.5 mm | variable data output RS232 / Digimatic / USB | Quick-Start-electronic (automatic switch on / saved position of zero) | waterproof according to IP67 | stainless steel | box



Art.-Nr. Order no.	Messbereich Range	Schnabel- abmessung Dimension of jaws	EUR
47-025	150 mm	10x2 mm	438,00

Digital-Messschieber mit langen Messspitzen *Digital caliper with long knife points*

Auflösung 0,01 mm / 0,0005 inch | Genauigkeit 0,03 mm | rostfreier Stahl | Datenausgang RB5 | Aufbewahrungsbox

Reading 0.01 mm / 0.0005 inch | accuracy 0.03 mm | stainless steel | data output RB5 | box



Art.-Nr. Order no.	Messbereich Range	Messspitzenlänge Length of knife points	EUR
10-641	150 mm	32 mm	76,50

Digital-Messschieber mit langen Messschnäbeln *Digital caliper with long jaws*

Auflösung 0,01 mm / 0,0005 inch | Genauigkeit 0,03 mm | rostfreier Stahl | Datenausgang RB5 | Aufbewahrungsbox

Reading 0.01 mm / 0.0005 inch | accuracy 0.03 mm | stainless steel | data output RB5 | box



Art.-Nr. Order no.	Messbereich Range	Schnabellänge Length of jaws	EUR
10-646	200 mm	80 mm	107,00

HELIOS-PREISSER Digital-Greiferspitzen-Messschieber *Digital caliper with gripper jaws*

Auflösung 0,01 mm / 0,0005 inch | Genauigkeit 0,03 mm | variabler Datenausgang RS232 / Digimatic / USB | QuickStart-Elektronik (automatisches Einschalten / gespeicherte Nullposition) | rostfreier Stahl | Aufbewahrungsbox

Reading 0.01 mm / 0.0005 inch | accuracy 0.03 mm | variable data output RS232 / Digimatic / USB | Quick-Start-electronic (automatic switch on / saved position of zero) | stainless steel | box



Art.-Nr. Order no.	Messbereich Range	Schnabellänge Length of jaws	Greiferspitzenzlänge Length of gripper jaws	EUR
47-031	250 mm	75 mm	55 mm	578,00

Messschieber Calipers

HELIOS-PREISSER Digital-Außensicherungsnuten-Messschieber *Digital outer notch caliper*

Auflösung 0,01 mm / 0,0005 inch | Genauigkeit 0,03 mm | variabler Datenausgang RS232 / Digimatic / USB | QuickStart-Elektronik (automatisches Einschalten / gespeicherte Nullposition) | wasserdicht gemäß IP65 | rostfreier Stahl | Aufbewahrungsbox

Reading 0.01 mm / 0.0005 inch | accuracy 0.03 mm | variable data output RS232 / Digimatic / USB | Quick-Start-electronic (automatic switch on / saved position of zero) | waterproof according to IP65 | stainless steel | box

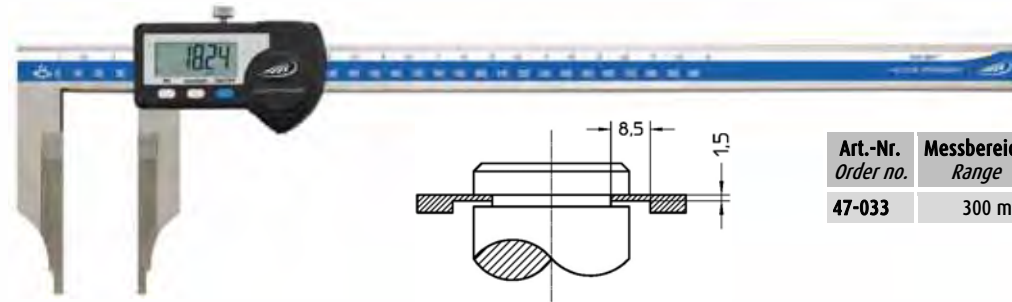

Art.-Nr. Order no.	Messbereich Range	Schnabellänge Length of jaws	EUR
47-033	300 mm	90 mm	481,00

Digital-Messschieber für Außen-Nuten *Digital caliper for outside grooves*

Auflösung 0,01 mm / 0,0005 inch | rostfreier Stahl | ohne Tiefenmaß | Datenausgang RB5 | Aufbewahrungsbox
Reading 0.01 mm / 0.0005 inch | stainless steel | without depth gauge | data output RB5 | box



Art.-Nr. Order no.	Messbereich Range	Genauigkeit Accuracy	Schnabellänge Length of jaws	Mess-Schnabel jaws	EUR
10-621	150 mm	0,04 mm	40 mm	5x1 mm	72,50
10-622	300 mm	0,05 mm	100 mm	10x2 mm	155,00
10-623	500 mm	0,07 mm	100 mm	12x2 mm	171,00

HELIOS-PREISSER Digital-Messschieber für Außen-Nuten *Digital caliper for outside grooves*

Auflösung 0,01 mm / 0,0005 inch | variabler Datenausgang RS232 / Digimatic / USB | QuickStart-Elektronik (automatisches Einschalten / gespeicherte Nullposition) | wasserdicht gemäß IP67 | rostfreier Stahl | Aufbewahrungsbox
Reading 0.01 mm / 0.0005 inch | variable data output RS232 / Digimatic / USB | Quick-Start-electronic (automatic switch on / saved position of zero) | waterproof according to IP67 | stainless steel | box



Art.-Nr. Order no.	Messbereich Range	Schnabellänge Length of jaws	EUR
47-041	150 mm	40 mm	562,00

Digital-Messschieber für Innen-Nuten *Digital caliper for inside grooves*

Auflösung 0,01 mm / 0,0005 inch | rostfreier Stahl | mit PRESET-Tasten | ohne Tiefenmaß | Datenausgang RB5 (nur bis 300 mm) | Aufbewahrungsbox
Reading 0.01 mm / 0.0005 inch | stainless steel | with PRESET keys | without depth gauge | data output RB5 (only up to 300 mm) | box



Art.-Nr. Order no.	Messbereich Range	Genauigkeit Accuracy	Schnabellänge Length of jaws	Mess-Schnabel jaws	EUR
10-630	16-150 mm	0,04 mm	30 mm	5x1,0 mm	84,50
10-631	22-170 mm				91,50
10-632	50-300 mm	0,05 mm	80 mm	8x1,5 mm	152,00
10-633	50-500 mm	0,07 mm	90 mm	10x1,5 mm	196,00
10-651	14-150 mm	0,04 mm	30 mm*	5x1,0 mm	99,00

*10-651: Messschnäbel oben *Measuring jaws at the top*

Messschieber Calipers

HELIOS-PREISSER Digital-Messschieber für Innen-Nuten *Digital caliper for inside grooves*

Auflösung 0,01 mm / 0,0005 inch | variabler Datenausgang RS232 / Digimatic / USB | QuickStart-Elektronik (automatisches Einschalten / gespeicherte Nullposition) | wasserdicht gemäß IP67 | rostfreier Stahl | Aufbewahrungsbox

Reading 0.01 mm / 0.0005 inch | variable data output RS232 / Digimatic / USB | Quick-Start-electronic (automatic switch on / saved position of zero) | waterproof according to IP67 | stainless steel | box



Art.-Nr. Order no.	Messbereich Range	Schnabellänge Length of jaws	EUR
47-043	20,5-170 mm	40 mm	557,00

Digital-Messschieber für Innen-Nuten mit kleinen Messschnäbeln *Digital caliper for inside grooves with small jaws*

Auflösung 0,01 mm / 0,0005 inch | rostfreier Stahl | mit PRESET-Tasten | ohne Tiefenmaß | Datenausgang RB5 | Aufbewahrungsbox

Reading 0.01 mm / 0.0005 inch | stainless steel | with PRESET keys | without depth gauge | data output RB5 | box



Art.-Nr. Order no.	Messbereich Range	Genauigkeit Accuracy	Schnabellänge Length of jaws	EUR
10-601	3-140 mm	0,04 mm	4,0 mm	96,00

Digital-Wanddicken-Messschieber *Digital caliper for wall thickness*

Auflösung 0,01 mm / 0,0005 inch | Genauigkeit 0,05 mm | rostfreier Stahl | ohne Tiefenmaß | Datenausgang RB5 | Aufbewahrungsbox

Reading 0.01 mm / 0.0005 inch | accuracy 0.05 mm | stainless steel | without depth gauge | data output RB5 | box



Art.-Nr. Order no.	Messbereich Range	Schnabellänge Length of jaws	EUR
10-611	150 mm	45 mm	85,50

HELIOS-PREISSER Digital-Wanddicken-Messschieber *Digital caliper for wall thickness*

Auflösung 0,01 mm / 0,0005 inch | variabler Datenausgang RS232 / Digimatic / USB | QuickStart-Elektronik (automatisches Einschalten / gespeicherte Nullposition) | wasserdicht gemäß IP67 | rostfreier Stahl | Aufbewahrungsbox

Reading 0.01 mm / 0.0005 inch | variable data output RS232 / Digimatic / USB | Quick-Start-electronic (automatic switch on / saved position of zero) | waterproof according to IP67 | stainless steel | box



Art.-Nr. Order no.	Messbereich Range	Schnabellänge Length of jaws	EUR
47-051	150 mm	40 mm	493,00

Messschieber Calipers

Digital-Messschieber mit verschiebbarem Messschnabel *Digital caliper with adjustable measuring jaws*

Auflösung 0,01 mm / 0,0005 inch | rostfreier Stahl | ohne Tiefenmaß | Datenausgang RB5 | Aufbewahrungsbox
 Reading 0.01 mm / 0.0005 inch | stainless steel | without depth gauge | data output RB5 | box



Art.-Nr. Order no.	Messbereich Range	Genauigkeit Accuracy	Schnabellänge Length of jaws	EUR
10-616	150 mm	0,04 mm	40-110 mm	87,50
10-617	200 mm	0,05 mm	40-120 mm	109,00

HELIOS-PREISSER Dig.- Messschieber mit verschiebbarem Messschnabel *Digital caliper with adjustable measuring jaws*

Auflösung 0,01 mm / 0,0005 inch | variabler Datenausgang RS232 / Digimatic / USB | QuickStart-Elektronik (automatisches Einschalten / gespeicherte Nullposition) | wasserdicht gemäß IP67 | rostfreier Stahl | Aufbewahrungsbox
 Reading 0.01 mm / 0.0005 inch | variable data output RS232 / Digimatic / USB | Quick-Start-electronic (automatic switch on / saved position of zero) | waterproof according to IP67 | stainless steel | box



Art.-Nr. Order no.	Messbereich Range	Schnabellänge Length of jaws	EUR
47-056	200 mm	40-65 mm	465,00

HELIOS-PREISSER Digital-Messschieber für Bohrungsabstandsmessung *Digital caliper for hole separation measurement*

Auflösung 0,01 mm / 0,0005 inch | variabler Datenausgang RS232 / Digimatic / USB | QuickStart-Elektronik (automatisches Einschalten / gespeicherte Nullposition) | wasserdicht gemäß IP67 | rostfreier Stahl | Aufbewahrungsbox
 Reading 0.01 mm / 0.0005 inch | variable data output RS232 / Digimatic / USB | Quick-Start-electronic (automatic switch on / saved position of zero) | waterproof according to IP67 | stainless steel | box

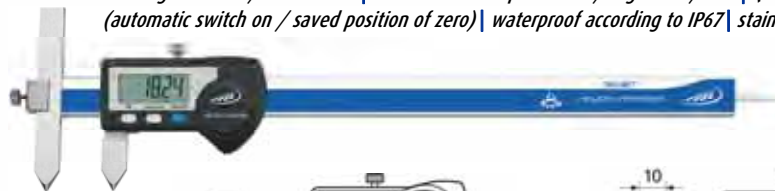

Art.-Nr. Order no.	Messbereich Range	EUR
47-058	10-210 mm	434,00

Anwendungsbeispiel
 Example of use

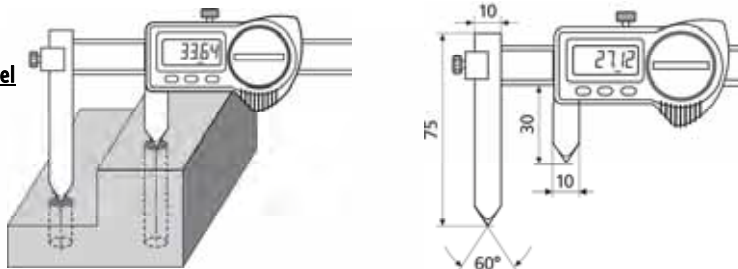

Digital-Messschieber mit Tellermessflächen *Digital caliper with disc measuring faces*

Auflösung 0,01 mm / 0,0005 inch | Genauigkeit 0,05 mm | rostfreier Stahl | Datenausgang RB5 | Aufbewahrungsbox
 Reading 0.01 mm / 0.0005 inch | accuracy 0.05 mm | stainless steel | data output RB5 | box



Art.-Nr. Order no.	Messbereich Range	Schnabellänge Length of jaws	Teller Disc	EUR
10-572	150 mm	50 mm	Ø20 mm	121,00

Messschieber Calipers

Digital-Messschieber mit Messbacken Digital caliper with large measuring faces

Auflösung 0,01 mm / 0,0005 inch | Genauigkeit 0,03 mm | rostfr. Stahl | Datenausgang RB5 | Box
 Reading 0.01 mm / 0.0005 inch | accuracy 0.03 mm | stainless steel | data output RB5 | box



Art.-Nr. Order no.	Messbereich Range	Messbacken Measuring faces	EUR
10-571	150 mm	25x25 mm	129,00



Digitaler 3/5-Punkt-Messschieber Digital 3/5-point caliper

Auflösung 0,01 mm / 0,0005 inch | Genauigkeit 0,04 mm | rostfreier Stahl | Aufbewahrungsbox
 Reading 0.01 mm / 0.0005 inch | accuracy 0.04 mm | stainless steel | box

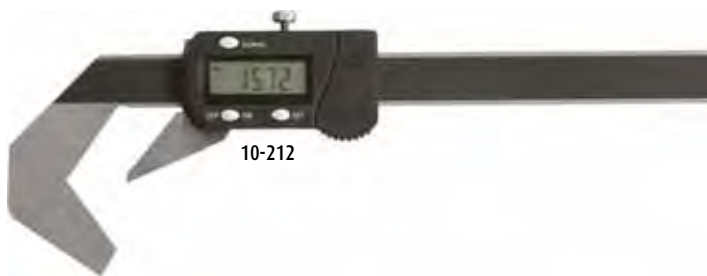

Art.-Nr. Order no.	Messbereich Range	Punkte points	Schnabel-Winkel Angle of jaws	EUR
10-211	4-40 mm	3	60°	144,00
10-212	2-40 mm	5	108°	144,00

Digital-Radius-Messschieber Digital radius caliper

Auflösung 0,01 mm / 0,0005 inch | zum Messen von Außen-Radien | rostfreier Stahl | Datenausgang RB5 | Aufbewahrungsbox
 Reading 0.01 mm / 0.0005 inch | for measuring of outside radiuses | stainless steel | data output RB5 | box

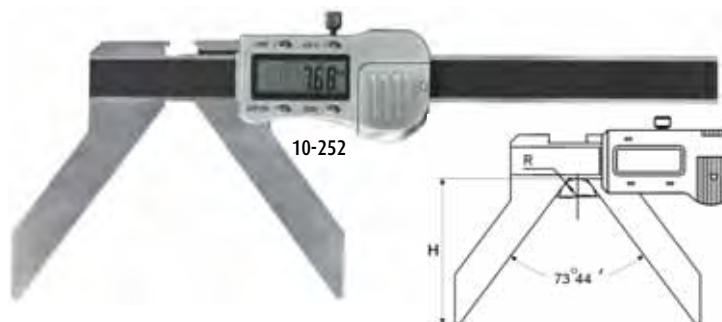

Art.-Nr. Order no.	Messbereich Range	Genauigkeit Accuracy	Schnabel-länge H Length of jaws H	EUR
10-251	3-50 mm	0,03 mm	22 mm	159,00
10-252	3-100 mm		42 mm	169,00
10-253	3-150 mm	0,04 mm	65 mm	197,00

Digital-Zahnweiten-Messschieber Digital caliper for width of teeth

Auflösung 0,01 mm / 0,0005 inch | Genauigkeit 0,03 mm | zum Messen von Zahnweiten | mit Feineinstellung | rostfreier Stahl | Aufbewahrungsbox
 Reading 0.01 mm / 0.0005 inch | Accuracy 0.03 mm | for measuring of width of teeth | with fine adjustment | stainless steel | box

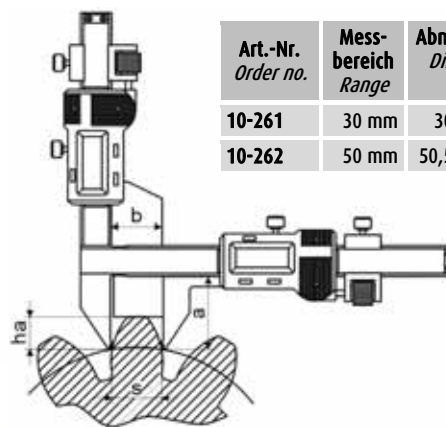

Art.-Nr. Order no.	Messbereich Range	Abmessungen Dimensions a/b	EUR
10-261	30 mm	30,5/21 mm	125,00
10-262	50 mm	50,5/50,5 mm	164,00

Messschieber Calipers

Digitales Universal-Messschieber-System *Digital universal caliper system*

Anwendungsbeispiele:
Examples of use:



Universal-Messschieber *Universal caliper*

Auflösung 0,01 mm / 0,0005 inch | rostfreier Stahl | ohne Tiefenmaß | ohne Messeinsätze | mit PRESET-Tasten | Datenausgang RB5 | Aufbewahrungsbox
Reading 0.01 mm / 0.0005 inch | stainless steel | w/o depth gauge | w/o measuring tips | with PRESET keys | data output RB5 | box



Art.-Nr. Order no.	Messbereich (X) Range (X)	Genauigkeit Accuracy	EUR
10-661	200 mm	0,04 mm	89,50
10-662	300 mm	0,05 mm	114,00

Messeinsätze (jeweils 1 Paar) *Measuring tips (1 pair in each case)*

- flache Messfläche für Nuten
flat measuring faces for grooves

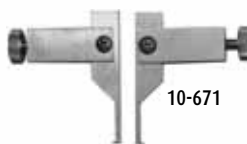

Art.-Nr. Order no.	Messfläche HxL Measuring tips HxL	Messbereich innen/außen Range inside/outside	Schnabellänge Length of jaws	EUR
10-671	0,4x1,0 mm	5-X / 11-X mm	12 mm	25,80
10-672	0,4x2,0 mm	7-X / 9-X mm	16 mm	29,80
10-673	0,6x5,0 mm	15-X / 1-X mm	25 mm	34,50
10-674	1,0x6,5 mm	20-X / 0-X mm	30 mm	38,50
10-675	1,5x10 mm	44-X / 0-X mm	80 mm	46,00

- runde Messfläche für Nuten
round measuring faces for grooves

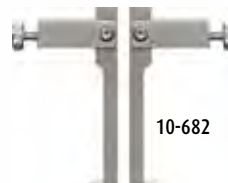

Art.-Nr. Order no.	Messstifte LxØ Measuring pins LxØ	Messbereich innen/außen Range inside/outside	Schnabellänge Length of jaws	EUR
10-681	2x1,0 mm	10-X / 6-X mm	20 mm	37,80
10-682	5x2,0 mm	20-X / 0-X mm	40 mm	42,00
10-683	10x2,0 mm	44-X / 0-X mm	80 mm	46,00

- ballige Messfläche
spherical measuring faces

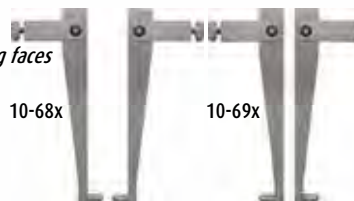

Art.-Nr. Order no.	Messstifte LxØ Measuring pins LxØ	Messbereich innen/außen Range inside/outside	Schnabellänge Length of jaws	EUR
10-686	7x2,0 mm	40-X / 0-X mm	70 mm	41,50
10-687	7x4,0 mm	42-X / 0-X mm	70 mm	46,00
10-691	7x2,0 mm	26-X / 0-X mm	70 mm	41,50
10-692	7x4,0 mm	28-X / 0-X mm	70 mm	46,00

- Kegel-Messfläche (zum Messen von Bohrungsabständen)
conical measuring faces (for hole distances)



Art.-Nr. Order no.	Durchmesser Diameter	EUR
10-696	5 mm	41,50
10-697	10 mm	49,50
10-698	15 mm	53,50

- für Aufnahme von Messuhr-Einsätzen M2,5 (M2,5-Einsätze: siehe Kapitel 03)
for inserts with metric thread M2.5 (inserts M2.5: see chapter 03)

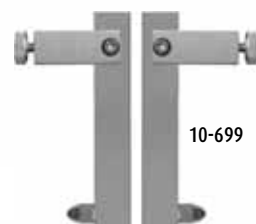

Art.-Nr. Order no.	Schnabellänge Length of jaws	EUR
10-699	60 mm	29,80

Weitere Messeinsätze auf Anfrage!
Further measuring tips on request!

Messschieber Calipers

Digitaler Universal-Messschieber für austauschbare Einsätze Ø5 mm *Digital universal caliper for changeable inserts Ø5 mm*

Anwendungsbeispiele:
Examples of use:



Messschieber (ohne Messeinsätze)
calipers (without inserts)

für Innen- und Außenmessung mit durchgehender Bohrung Ø5 mm | Auflösung 0,01 mm | rostfreier Stahl | ohne Tiefenmaß | mit PRESET-Tasten | Datenausgang RB5 (nur bis 300 mm) | Aufbewahrungsbox | ohne Messeinsätze
for inside and outside measuring with end-to-end hole Ø5 mm | Reading 0.01 mm | stainless steel | without depth gauge | with PRESET keys | data output RB5 (only up to 300 mm) | box | without inserts



Art.-Nr. Order no.	Messbereich Range	Schnabellänge Length of jaws	Genauigkeit Accuracy	EUR
10-666	150 mm	40 mm	0,04 mm	147,00
10-667	200 mm	80 mm	0,05 mm	199,00
10-668	300 mm	100 mm	0,07 mm	223,00
10-669	500 mm	150 mm	0,09 mm	322,00

passende Messeinsätze (jeweils 1 Paar)
suitable inserts (1 pair in each case)

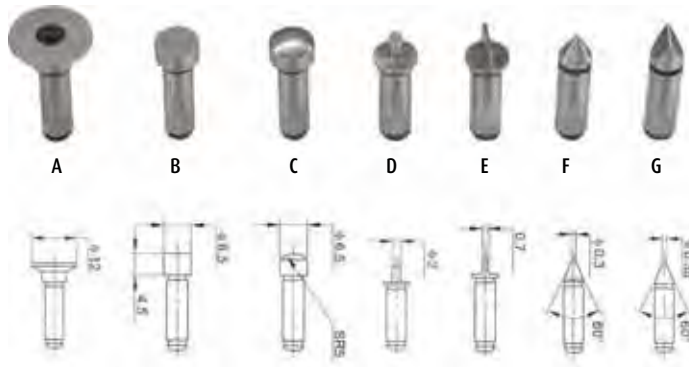

Art.-Nr. Order no.	Typ Type	Abb. figure	EUR
10-670-1	Teller <i>disc</i> Ø12 mm	A	17,80
10-670-2	planparallel <i>parallel</i> Ø6,5 mm	B	17,80
10-670-3	ballig <i>spherical</i> Ø6,5 mm	C	17,80
10-670-4	Stift <i>pin</i> Ø2 mm	D	17,80
10-670-5	flach <i>flat</i> 0,7 mm	E	17,80
10-670-6	kegelig <i>conical</i> 60°	F	17,80
10-670-7	keilförmig <i>wedge-shaped</i> 60°	G	17,80

Verlängerungs-Messeinsätze (austauschbare Spitze Kugel Ø2 mm / Aufnahmegewinde M2,5) (jeweils 1 Stück)
lengthening piece (changeable measuring tip ball Ø2 mm / thread M2.5) (1 piece in each case)



Art.-Nr. Order no.	Länge Length	EUR
10-670-8	50 mm	9,50
10-670-9	100 mm	11,50

Anwendungsbeispiel:
Example of use:



1x 10-666 und and 2x 10-670-8

Messschieber Calipers

Digitaler Universal-Messschieber mit auswechselbaren Einsätzen M2,5 *Digital universal caliper with changeable inserts M2.5*

individuell anpassbar für Innen- und Außenmessung durch Messeinsätze mit Gewinde M2,5 (=Messuhr-Standard-Einsätze, siehe Kapitel 03) | Auflösung 0,01 mm | rostfreier Stahl | ohne Tiefenmaß | mit PRESET-Tasten | Datenausgang RB5 | Aufbewahrungsbox | Lieferung mit 1 Paar Kugel-Messeinsätze
individually customizable for inside and outside measuring through inserts with thread M2.5 (=standard inserts for dial gauges, look at chapter 03) | Reading 0.01 mm | stainless steel | without depth gauge | with PRESET keys | data output RB5 | box | incl. 1 pair of inserts "ball"



Art.-Nr. Order no.	Messbereich Range	Schnabellänge Length of jaws	Genauigkeit Accuracy	EUR
10-711	150 mm	45 mm	0,04 mm	127,00
10-712	200 mm	80 mm	0,05 mm	155,00

HELIOS-PREISSER Digitaler Universal-Messschieber mit auswechselbaren Einsätzen M2,5 *Digital universal caliper with changeable inserts M2.5*

individuell anpassbar durch Messeinsätze mit Gewinde M2,5 (Standard-Einsätze für Messuhren, siehe Kapitel 03) | für Innen- und Außenmessungen | Auflösung 0,01 mm / 0,0005 inch | Werksnorm | variabler Datenausgang RS232/Digimatic/USB | wasserdicht gemäß IP67 (IP65 ab Messbereich 300 mm) | automatisches Ein-/Ausschalten | Preset-Funktion (Messwertvoreinstellung) | Aufbewahrungsbox | inkl. Einstelllehre und Messeinsatzpaare „Kugel“ Ø5 mm und „Plan“ Ø4,8 mm (nur bei Messbereich 150 mm)



individually customizable through inserts with thread M2.5 (standard inserts for dial gauges, look at chapter 03) | for inside and outside measuring | Reading 0.01 mm / 0.0005 inch | factory standard | variable data output RS232 / Digimatic / USB | waterproof according to IP67 (IP65 from range 300 mm) | automatic switch-on/switch-off | Preset-function | box | incl. setting gauge and pairs of inserts "ball" Ø5 mm and "planar" Ø4.8 mm (only range 150 mm)



Art.-Nr. Order no.	Messbereich Range	Schnabellänge Length of jaws	Schnabelbreite b Width of jaws b	EUR
46-081	150 mm	40 mm	5 mm	352,00
46-082	300 mm	90 mm	12 mm	595,00
46-083	500 mm	100 mm	16 mm	760,00

HELIOS-PREISSER Datenübertragungskabel für variablen Datenausgang *Data transfer cable for variable data output*

für alle HELIOS-PREISSER Messgeräte mit variablem Datenausgang | Länge 2 m | mit Datenübertragungstaste | Software „MarCom Professional“ für Windows 7/8/10 zum Übertragen der Messwerte in Anwendungen kostenlos downloadbar auf www.helios-preisser.de

For all HELIOS-PREISSER measuring tools with variable data output | length 2 m | with data transfer button | software "MarCom Professional" for Windows 7/8/10 for transferring measuring values into applications free download at www.helios-preisser.de

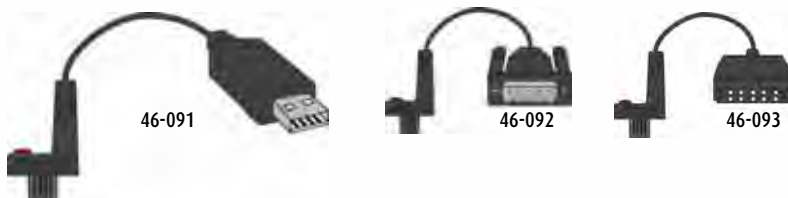

Art.-Nr. Order no.	Schnittstelle Interface	EUR
46-091	USB	69,50
46-092	RS232	49,00
46-093	Digimatic	62,50

Weitere Informationen und Zubehör zum Thema Datenübertragung finden Sie in Kapitel 15!
Further information and accessories related to data transfer can be found in chapter 15!

Messschieber Calipers

Digital-Werkstattmessschieber ohne Messerspitzen *Digital workshop caliper without points*

Auflösung 0,01 mm / 0,0005 inch | mit Feineinstellung | rostfreier Stahl | Lochmaßansatz Ø10 mm | Datenausgang RB5 | Aufbewahrungsbox
Reading 0.01 mm / 0.0005 inch | with fine adjustment | stainless steel | Hole size measuring top Ø10 mm | data output RB5 | box



Art.-Nr. Order no.	Messbereich Range	Schnabellänge Length of jaws	Genauigkeit Accuracy	EUR
10-701	200 mm	75 mm	0,03 mm	94,50
10-702	300 mm	90 mm	0,05 mm	109,00

Auflösung 0,01 mm / 0,0005 inch | mit Feineinstellung | rostfreier Stahl | Lochmaßansatz Ø20 mm | Datenausgang RB5
Reading 0.01 mm / 0.0005 inch | with fine adjustment | stainless steel | Hole size measuring top Ø20 mm | data output RB5



Art.-Nr. Order no.	Messbereich Range	Schnabellänge Length of jaws	Genauigkeit Accuracy	Gewicht weight	EUR
10-071	300 mm	150 mm	0,03 mm	0,9 kg	166,00
10-072-1	500 mm	150 mm	0,05 mm	1,1 kg	186,00
10-072-3		250 mm		3,9 kg	294,00
10-073-1	800 mm	150 mm	0,07 mm	2,2 kg	329,00
10-073-3		300 mm		5,0 kg	525,00
10-074-1	1000 mm	150 mm	0,07 mm	2,5 kg	427,00
10-074-3		300 mm		5,2 kg	719,00
10-075	1500 mm	200 mm	0,11 mm	3,5 kg	1048,00
10-076		300 mm		6,7 kg	1198,00
10-077	2000 mm	200 mm	0,14 mm	4,0 kg	1375,00
10-078		300 mm		8,2 kg	1685,00

Digital-Werkstattmessschieber mit Messerspitzen *Digital workshop caliper with points*

Auflösung 0,01 mm / 0,0005 inch | mit Feineinstellung | rostfreier Stahl | Lochmaßansatz Ø10 mm | Datenausgang RB5 | Aufbewahrungsbox
Reading 0.01 mm / 0.0005 inch | with fine adjustment | stainless steel | Hole size measuring top Ø10 mm | data output RB5 | box



Art.-Nr. Order no.	Messbereich Range	Schnabellänge Length of jaws	Genauigkeit Accuracy	EUR
10-088	300 mm	60 mm	0,03 mm	108,00
10-089		90 mm	0,05 mm	143,00

Auflösung 0,01 mm / 0,0005 inch | mit Feineinstellung | rostfreier Stahl | Lochmaßansatz Ø20 mm | Datenausgang RB5
Reading 0.01 mm / 0.0005 inch | with fine adjustment | stainless steel | Hole size measuring top Ø20 mm | data output RB5



Art.-Nr. Order no.	Messbereich Range	Schnabellänge Length of jaws	Genauigkeit Accuracy	Gewicht weight	EUR
10-082	500 mm	150 mm	0,05 mm	1,2 kg	245,00
10-084	1000 mm		0,07 mm	2,6 kg	468,00
10-085	1500 mm	200 mm	0,11 mm	3,6 kg	1085,00
10-086	2000 mm		0,14 mm	4,1 kg	1445,00

Messschieber Calipers

HELIOS-PREISSER Digitaler Werkstattmessschieber ohne Messerspitzen Digital workshop caliper without points

Auflösung 0,01 mm / 0,0005 inch | DIN 862 | ohne Messerspitzen | rostfreier Stahl | Lochmaßansatz Ø20 mm (bei Messbereich 300 mm: Ø10 mm) | Feststellschraube | Preset-Funktion (Messwertvoreinstellung) | variabler Datenausgang RS232 / Digimatic / USB | induktives Messsystem | Made in Germany | Holzetui | inkl. Hersteller-Kalibrierzertifikat

Reading 0.01 mm / 0.0005 inch | DIN 862 | without points | stainless steel | Hole size measuring top Ø20 mm (Range 300 mm: Ø10 mm) | set screw | Preset-function | variable data output RS232 / Digimatic / USB | inductive measuring system | Made in Germany | wooden box | manufacturers calibration certificate included



46-171FW

Art.-Nr. Order no.	Messbereich Range	Genauigkeit Accuracy	Schnabellänge Length of jaws	Feineinstellung fine adjustment	wasserdicht waterproof	EUR	
46-171	300 mm	0,03 mm	90 mm	ohne without	-	359,00	
46-171W				mit with	IP65	388,00	
46-171F				ohne without	-	414,00	
46-171FW				mit with	IP65	443,00	
46-172	500 mm		0,03 mm	125 mm	ohne without	-	508,00
46-172W					mit with	IP65	717,00
46-172F					ohne without	-	584,00
46-172FW					mit with	IP65	772,00
46-173	800 mm	0,04 mm		150 mm	ohne without	-	892,00
46-173W					mit with	IP65	991,00
46-173F					ohne without	-	953,00
46-173FW					mit with	IP65	1047,00
46-174	1000 mm		0,04 mm	150 mm	ohne without	-	1049,00
46-174W					mit with	IP65	1234,00
46-174F					ohne without	-	1098,00
46-174FW					mit with	IP65	1288,00

Auflösung 0,01 mm / 0,0005 inch | Werksnorm | ohne Messerspitzen | rostfreier Stahl | Lochmaßansatz Ø30 mm | Feststellschraube | Preset-Funktion (Messwertvoreinstellung) | Datenausgang Opto RS232 | Made in Germany | Holzetui

Reading 0.01 mm / 0.0005 inch | factory standard | without points | stainless steel | Hole size measuring top Ø30 mm | set screw | Preset-function | data output Opto RS232 | Made in Germany | wooden box

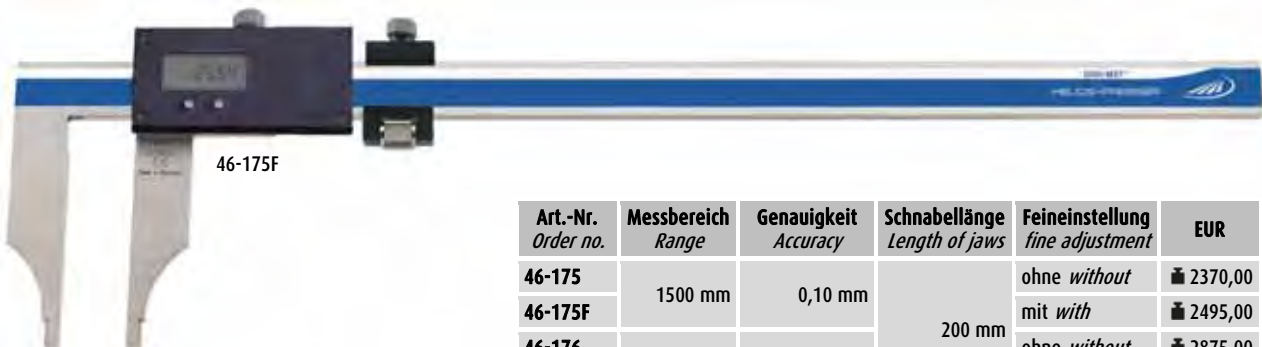

46-175F

Art.-Nr. Order no.	Messbereich Range	Genauigkeit Accuracy	Schnabellänge Length of jaws	Feineinstellung fine adjustment	EUR
46-175	1500 mm	0,10 mm	200 mm	ohne without	2370,00
46-175F				mit with	2495,00
46-176	2000 mm	0,12 mm		ohne without	2875,00
46-176F				mit with	2965,00

Informationen und Zubehör zum Thema Datenübertragung finden Sie in Kapitel 15!
Information and accessories related to data transfer can be found in chapter 15!



Messschieber Calipers

HELIOS-PREISSER Digitaler Werkstattmessschieber mit Messerspitzen

Digital workshop caliper with points

Auflösung 0,01 mm / 0,0005 inch | DIN 862 | mit Messerspitzen | rostfreier Stahl | Lochmaßansatz Ø20 mm (bei Messbereich 300 mm: Ø10 mm) | Feststellschraube | Preset-Funktion (Messwertvoreinstellung) | variabler Datenausgang RS232 / Digimatic / USB | induktives Messsystem | Made in Germany | Holzetui | inkl. Hersteller-Kalibrierzertifikat

Reading 0.01 mm / 0.0005 inch | DIN 862 | with points | stainless steel | Hole size measuring top Ø20 mm (Range 300 mm: Ø10 mm) | set screw | Preset-function | variable data output RS232 / Digimatic / USB | inductive measuring system | Made in Germany | wooden box | manufacturers calibration certificate included

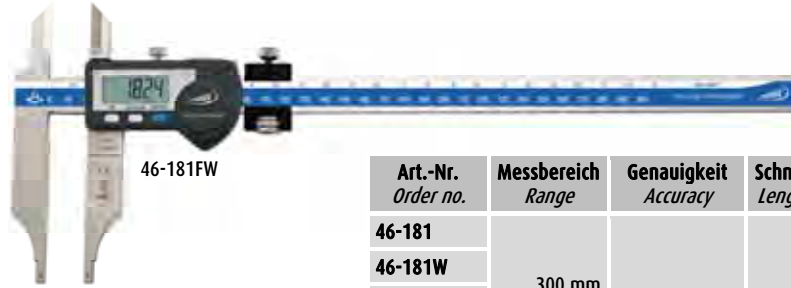

46-181FW

Art.-Nr. Order no.	Messbereich Range	Genauigkeit Accuracy	Schnabellänge Length of jaws	Feineinstellung fine adjustment	wasserdicht waterproof	EUR	
46-181	300 mm	0,03 mm	90 mm	ohne without	-	389,00	
46-181W				mit with	IP65	423,00	
46-181F				ohne without	-	453,00	
46-181FW				mit with	IP65	478,00	
46-182	500 mm		0,04 mm	125 mm	ohne without	-	595,00
46-182W					mit with	IP65	806,00
46-182F					ohne without	-	667,00
46-182FW					mit with	IP65	861,00
46-183	800 mm	0,04 mm		150 mm	ohne without	-	972,00
46-183W					mit with	IP65	1088,00
46-183F					ohne without	-	1038,00
46-183FW					mit with	IP65	1142,00
46-184	1000 mm		0,04 mm	150 mm	ohne without	-	1176,00
46-184W					mit with	IP65	1338,00
46-184F					ohne without	-	1182,00
46-184FW					mit with	IP65	1392,00

Auflösung 0,01 mm / 0,0005 inch | Werksnorm | mit Messerspitzen | rostfreier Stahl | Lochmaßansatz Ø30 mm | Feststellschraube | Preset-Funktion (Messwertvoreinstellung) | Datenausgang Opto RS232 | Made in Germany | Holzetui

Reading 0.01 mm / 0.0005 inch | factory standard | with points | stainless steel | Hole size measuring top Ø30 mm | set screw | Preset-function | data output Opto RS232 | Made in Germany | wooden box

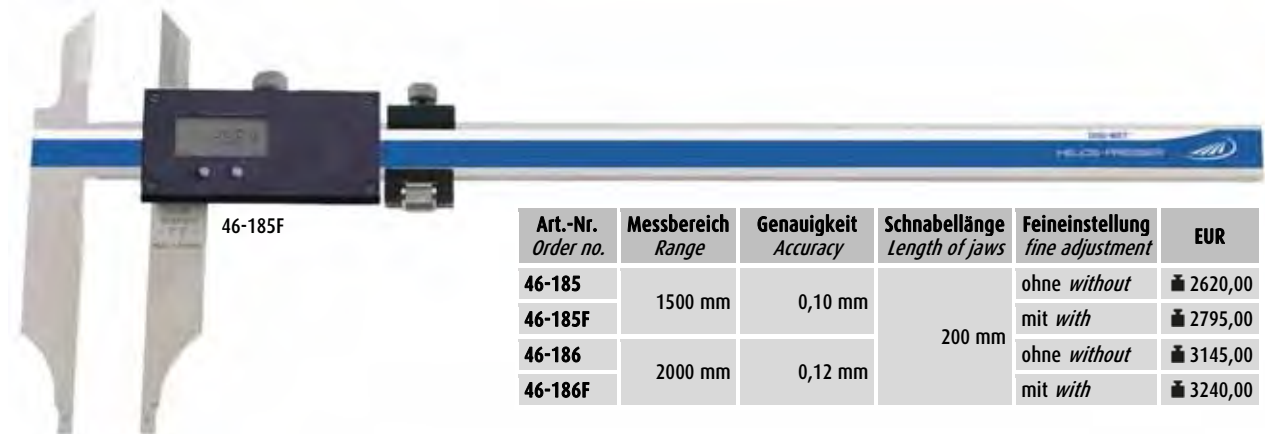

46-185F

Art.-Nr. Order no.	Messbereich Range	Genauigkeit Accuracy	Schnabellänge Length of jaws	Feineinstellung fine adjustment	EUR
46-185	1500 mm	0,10 mm	200 mm	ohne without	2620,00
46-185F				mit with	2795,00
46-186	2000 mm	0,12 mm		ohne without	3145,00
46-186F				mit with	3240,00

Informationen und Zubehör zum Thema Datenübertragung finden Sie in Kapitel 15!

Information and accessories related to data transfer can be found in chapter 15!

Messschieber Calipers

Digital-Werkstattmessschieber mit Kreuzspitzen *Digital workshop caliper with cross points*

Auflösung 0,01 mm / 0,0005 inch | mit Feineinstellung | rostfreier Stahl | Lochmaßansatz Ø10 mm (bei Messbereich 300 mm), Ø20 mm (ab 500 mm) | Datenausgang RBS | Aufbewahrungsbox
Reading 0.01 mm / 0.0005 inch | with fine adjustment | stainless steel | Hole size measuring top Ø10 mm (for range 300 mm), Ø20 mm (from 500 mm) | data output RBS | box



Art.-Nr. Order no.	Messbereich Range	Schnabellänge Length of jaws	Genauigkeit Accuracy	Gewicht weight	EUR
10-371	300 mm	90 mm	0,04 mm	0,8 kg	182,00
10-372	500 mm	150 mm	0,05 mm	1,2 kg	286,00
10-374	1000 mm		0,10 mm	2,4 kg	483,00

HELIOS-PREISSER Digitaler Werkstattmessschieber mit Kreuzspitzen *Digital workshop caliper with cross points*

Auflösung 0,01 mm / 0,0005 inch | DIN 862 | mit Kreuzspitzen | rostfreier Stahl | Lochmaßansatz Ø20 mm (bei Messbereich 300 mm: Ø10 mm) | Feststellschraube | Preset-Funktion (Messwertvoreinstellung) | variabler Datenausgang RS232 / Digimatic / USB | Made in Germany | Holzetui
Reading 0.01 mm / 0.0005 inch | DIN 862 | with cross points | stainless steel | Hole size measuring top Ø20 mm (Range 300 mm: Ø10 mm) | set screw | Preset-function | variable data output RS232 / Digimatic / USB | Made in Germany | wooden box

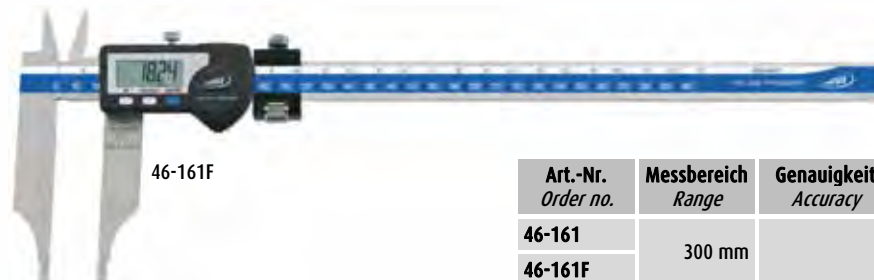

Art.-Nr. Order no.	Messbereich Range	Genauigkeit Accuracy	Schnabellänge Length of jaws	Feineinstellung fine adjustment	EUR
46-161	300 mm	0,03 mm	90 mm	ohne without	545,00
46-161F				mit with	579,00
46-162	500 mm		125 mm	ohne without	698,00
46-162F				mit with	769,00

HELIOS-PREISSER Datenübertragungskabel für variablen Datenausgang *Data transfer cable for variable data output*

für alle HELIOS-PREISSER Messgeräte mit variablem Datenausgang | Länge 2 m | mit Datenübertragungstaste | Software „MarCom Professional“ für Windows 7/8/10 zum Übertragen der Messwerte in Anwendungen kostenlos downloadbar auf www.helios-preisser.de

For all HELIOS-PREISSER measuring tools with variable data output | length 2 m | with data transfer button | software "MarCom Professional" for Windows 7/8/10 for transferring measuring values into applications free download at www.helios-preisser.de

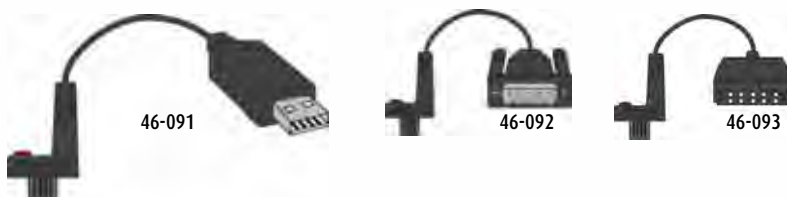

Art.-Nr. Order no.	Schnittstelle Interface	EUR
46-091	USB	69,50
46-092	RS232	49,00
46-093	Digimatic	62,50

Weitere Informationen und Zubehör zum Thema Datenübertragung finden Sie in Kapitel 15!
Further information and accessories related to data transfer can be found in chapter 15!

Messschieber Calipers

Digital-Werkstattmessschieber IP65 (wasser-/staubdicht) Digital workshop caliper IP65 (water-proof/dustproof)

Auflösung 0,01 mm / 0,0005 inch | DIN 862 | mit Feineinstellung | rostfreier Stahl | Lochmaßansatz Ø10 mm (bei Messbereich 300 mm), Ø20 mm (ab 600 mm) | Aufbewahrungsbox
 Reading 0.01 mm / 0.0005 inch | DIN 862 | with fine adjustment | stainless steel | Hole size measuring top Ø10 mm (for range 300 mm), Ø20 mm (from 600 mm) | box



Art.-Nr. Order no.	Messbereich Range	Schnabellänge Length of jaws	Gewicht weight	EUR
10-391	300 mm	90 mm	0,9 kg	174,00
10-393	600 mm	150 mm	1,4 kg	293,00
10-394	1000 mm		2,6 kg	536,00

Digital-Leichtmetall-Werkstattmessschieber 0,1 mm Digital light metal workshop caliper 0.1 mm

Auflösung 0,1 mm / 0,01 inch | Lochmaßansatz Ø20 mm | Messschnabellänge 150 mm | beide Messschnäbel verstellbar für optimalen Gewichtsausgleich | großes Display 14 mm
 Reading 0.1 mm / 0.01 inch | Hole size measuring top Ø20 mm | Length of jaws 150 mm | both jaws adjustable for optimal weight compensation | large display 14 mm



Art.-Nr. Order no.	Messbereich Range	Genauigkeit Accuracy	Gewicht weight	EUR
10-351	500 mm	0,2 mm	0,7 kg	129,00
10-352	800 mm	0,3 mm	0,8 kg	178,00
10-353	1000 mm		0,9 kg	199,00
10-354	1500 mm	0,5 mm	1,1 kg	296,00

Digital-Leichtmetall-Werkstattmessschieber „Light-Line“ Digital light metal workshop caliper „Light-Line“

Auflösung 0,01 mm | Messschnäbel aus rostfreiem Stahl | Lochmaßansatz Ø20 mm | Messschnabellänge 150 mm | Sylvac-Elektronik | beide Messschnäbel verstellbar für optimalen Gewichtsausgleich | optimale Gleiteigenschaften durch innenliegende, doppelte Prismenführung | Aufbewahrungsbox | Made in Germany

Reading 0.01 mm | Jaws made from stainless steel | Hole size measuring top Ø20 mm | Length of jaws 150 mm | Sylvac electronic | both jaws adjustable for optimal weight compensation | best sliding characteristic through inside double V-block | box | Made in Germany



Art.-Nr. Order no.	Messbereich Range	Genauigkeit* Accuracy*	Gewicht weight	EUR
10-304	1000 mm	0,06 mm	1,7 kg	739,00
10-305	1500 mm	0,07 mm	2,0 kg	1095,00
10-306	2000 mm	0,08 mm	2,4 kg	1380,00
10-307	2500 mm	0,13 mm	2,9 kg	1795,00
10-308	3000 mm	0,18 mm	3,4 kg	2155,00

*bei voll anliegenden Messflächen *with fully fitted jaws

Messschieber Calipers

Digital-Tiefenmessschieber *Digital depth caliper*

Auflösung 0,01 mm / 0,0005 inch | DIN 862 | rostfreier Stahl | Metallgehäuse | Datenausgang RB5 | Aufbewahrungsbox
Reading 0.01 mm / 0.0005 inch | DIN 862 | stainless steel | metal housing | data output RB5 | box

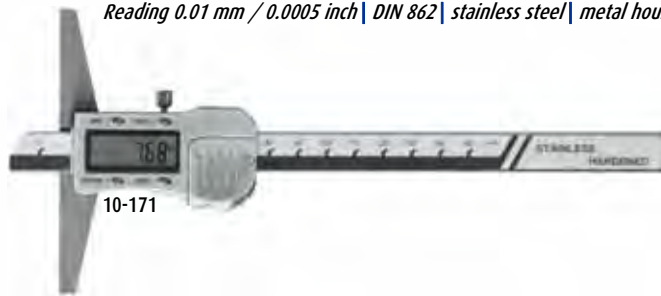

Art.-Nr. Order no.	Messbereich Range	Brückenlänge Length of base	EUR
10-171	150 mm	100 mm	45,50
10-172	200 mm		59,50
10-173	300 mm	150 mm	93,50

Digital-Leichtmetall-Tiefenmessschieber „Light-Line“ *Digital light metal depth caliper „Light-Line“*

Auflösung 0,01 mm / 0,0005 inch | jeweils inkl. 3 harteloxierten Messbrücken 150/300/450 mm | als Tiefenmessschieber und Hakenmessschieber verwendbar | Aufnahme für Messeinsätze M2,5 (M2,5-Einsätze: siehe Kapitel 03) | Aufbewahrungsbox | Made in Germany
Reading 0.01 mm / 0.0005 inch | each with 3 hard anodized bases 150/300/450 mm | usable as depth caliper or hook caliper | seat for inserts M2.5 (inserts M2.5: see chapter 03) | box | Made in Germany

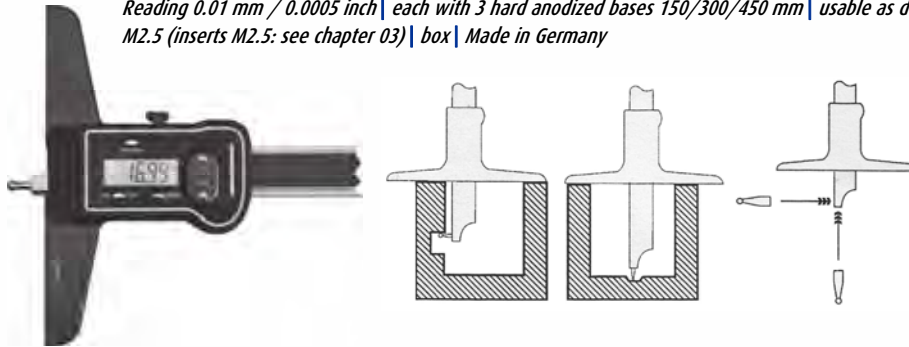

Art.-Nr. Order no.	Messbereich Range	Genauigkeit Accuracy	EUR
10-341	300 mm	0,04 mm	269,00
10-342	500 mm	0,05 mm	360,00
10-343	800 mm	0,06 mm	448,00

Digital-Tiefenmessschieber IP67 (wasser-/staubdicht) *Digital depth caliper IP67 (waterproof/dustproof)*

Auflösung 0,01 mm / 0,0005 inch | DIN 862 | rostfreier Stahl | Sylvac-Elektronik ohne Datenausgang | Aufbewahrungsbox
Reading 0.01 mm / 0.0005 inch | DIN 862 | stainless steel | Sylvac-electronic without data output | box



Art.-Nr. Order no.	Messbereich Range	Brückenlänge Length of base	EUR
10-196	150 mm	100 mm	132,00
10-197	200 mm		159,00
10-198	300 mm	150 mm	234,00

HELIOS-PREISSER Digital-Tiefenmessschieber IP67 (wasser-/staubdicht) *Digital depth caliper IP67*

Auflösung 0,01 mm / 0,0005 inch | DIN 862 | rostfreier Stahl | wasserdicht gemäß IP67 | Feststellschraube | Preset-Funktion (Messwertvoreinstellung) | variabler Datenausgang RS232 / Digimatic / USB | Made in Germany | Holzetui | inkl. Hersteller-Kalibrierzertifikat

Reading 0.01 mm / 0.0005 inch | DIN 862 | stainless steel | waterproof according to IP67 | set screw | Preset function | variable data output RS232 / Digimatic / USB | Made in Germany | wooden box | manufacturers calibration certificate included



Art.-Nr. Order no.	Messbereich Range	Brückenlänge Length of base	LCD-Anzeige LCD display	EUR
46-251	150 mm	100 mm	7,5 mm	323,00
46-252	200 mm			366,00
46-253	300 mm	150 mm		411,00
46-254	500 mm		472,00	
46-255	1000 mm	250 mm	12,5 mm	1345,00

Informationen und Zubehör zum Thema Datenübertragung finden Sie in Kapitel 15!
Information and accessories related to data transfer can be found in chapter 15!

Messschieber Calipers

Digital-Kleintiefenmessschieber *Digital small depth caliper*

Auflösung 0,01 mm / 0,0005 inch | Messstift 30xØ2 mm | DIN 862 | rostfreier Stahl | Datenausgang RB5 | Aufbewahrungsbox
Reading 0.01 mm / 0.0005 inch | measuring pin 30xØ2 mm | DIN 862 | stainless steel | data output RB5 | box



Art.-Nr. Order no.	Messbereich Range	Brückenlänge Length of base	EUR
10-186	30 mm	60 mm	56,50

HELIOS-PREISSER Digital-Kleintiefenmessschieber IP67 (wasserdicht) *Digital depth caliper IP67 (waterproof)*

Auflösung 0,01 mm / 0,0005 inch | Messstift Ø2mm | Genauigkeit 0,02 mm | rostfreier Stahl | wasserdicht (IP67) | Preset-Funktion (Messwertvoreinstellung) | variabler Datenausgang RS232 / Digimatic / USB | Made in Germany | Holzetui
Reading 0.01 mm / 0.0005 inch | measuring pin Ø2 mm | Accuracy 0.02 mm | stainless steel | waterproof according to IP67 | Preset function | variable data output RS232 / Digimatic / USB | Made in Germany | wooden box



Art.-Nr. Order no.	Messbereich Range	Brückenlänge Length of base	EUR
46-291	25 mm	48 mm	244,00

Informationen und Zubehör zum Thema Datenübertragung finden Sie in Kapitel 15!
Information and accessories related to data transfer can be found in chapter 15!

Digital-Tiefenmessschieber mit rundem Messstift *Digital depth caliper with round measuring pin*

Auflösung 0,01 mm / 0,0005 inch | Messstift 6,0xØ1,5 mm | DIN 862 | rostfreier Stahl | Datenausgang RB5 | Aufbewahrungsbox
Reading 0.01 mm / 0.0005 inch | measuring pin 6.0xØ1.5 mm | DIN 862 | stainless steel | data output RB5 | box



Art.-Nr. Order no.	Messbereich Range	Brückenlänge Length of base	EUR
10-181	80 mm	50 mm	56,50
10-182	200 mm	100 mm	76,50
10-183	300 mm	150 mm	129,00

HELIOS-PREISSER Dig.-Tiefenmessschieber IP67 mit rundem Messstift *Digital depth caliper IP67 with round measuring pin*

Auflösung 0,01 mm / 0,0005 inch | Messstift Ø1,5x5 mm | DIN 862 | rostfreier Stahl | wasserdicht gemäß IP67 | großes Display 11 mm | QuickStart-Elektronik (automatisches Einschalten / gespeicherte Nullposition) | Preset-Funktion (Messwertvoreinstellung) | Aufbewahrungsbox | inkl. Hersteller-Kalibrierzertifikat
Reading 0.01 mm / 0.0005 inch | measuring pin Ø1.5x5 mm | DIN 862 | stainless steel | waterproof according to IP67 | large display 11 mm | Quick-Start-electronic (automatic switch on / saved position of zero) | Preset-Function | box | manufacturers calibration certificate included



Art.-Nr. Order no.	Messbereich Range	Brückenlänge Length of base	EUR
46-260	150 mm	100 mm	379,00
46-261	200 mm	100 mm	418,00
46-262	300 mm	150 mm	465,00
46-263	500 mm	150 mm	538,00

Messschieber Calipers

HELIOS-PREISSER Digital-Tiefenmessschieber IP67 mit rundem Messstift und Funk-Datenübertragung *Digital depth caliper IP67 with round measuring pin and wireless data output*

Auflösung 0,01 mm / 0,0005 inch | Messstift Ø1,5x5 mm | DIN 862 | rostfreier Stahl | wasserdicht gemäß IP67 | großes Display 11 mm | integrierter Funksender „Integrated Wireless“ | QuickStart-Elektronik (automatisches Einschalten / gespeicherte Nullposition) | Preset-Funktion (Messwertvoreinstellung) | Aufbewahrungsbox | inkl. Hersteller-Kalibrierzertifikat

Reading 0.01 mm / 0.0005 inch | measuring pin Ø1.5x5 mm | DIN 862 | stainless steel | waterproof according to IP67 | large display 11 mm | data output with "Integrated Wireless" | Quick-Start-electronic (automatic switch on / saved position of zero) | Preset-Function | box | manufacturers calibration certificate included



46-265

Art.-Nr. Order no.	Messbereich Range	Brückenlänge Length of base	EUR
46-265	150 mm	100 mm	424,00
46-266	200 mm		449,00
46-267	300 mm	150 mm	506,00
46-268	500 mm		573,00

Informationen und Zubehör zum Thema Datenübertragung finden Sie in Kapitel 15!
Information and accessories related to data transfer can be found in chapter 15!

HELIOS-PREISSER Digital-Einhand-Tiefenmessschieber *Digital one-hand operation depth caliper*

Auflösung 0,01 mm / 0,0005 inch | wechselbarer Messeinsatz mit Gewinde M2,5 (Standard-Einsätze für Messuhren, siehe Kapitel 03) | konstante Messkraft durch Federdruck | Genauigkeit 0,02 mm | rostfreier Stahl | wasserdicht gemäß IP67 | variabler Datenausgang RS232 / Digimatic / USB | QuickStart-Elektronik (automatisches Einschalten / gespeicherte Nullposition) | Preset-Funktion (Messwertvoreinstellung) | Aufbewahrungsbox

Reading 0.01 mm / 0.0005 inch | changeable inserts with thread M2.5 (standard inserts for dial gauges, look at chapter 03) | constant measuring force through spring pressure | accuracy 0.02 mm | stainless steel | waterproof according to IP67 | variable data output RS232 / Digimatic / USB | Quick-Start-electronic (automatic switch on / saved position of zero) | Preset-Function | box



46-293

Art.-Nr. Order no.	Messbereich Range	EUR
46-293	60 mm	769,00
46-294	100 mm	829,00

Informationen und Zubehör zum Thema Datenübertragung finden Sie in Kapitel 15!
Information and accessories related to data transfer can be found in chapter 15!

Digital-Tiefenmessschieber mit Haken *Digital depth caliper with hooks*

Auflösung 0,01 mm / 0,0005 inch | Metallgehäuse (bis Messbereich 500 mm) / Kunststoffgehäuse (bei 10-165) | DIN 862 | rostfreier Stahl | Datenausgang RB5 (nur bis 500 mm) | Aufbewahrungsbox

Reading 0.01 mm / 0.0005 inch | metal housing (up to range 500 mm) / plastic housing (article 10-165) | DIN 862 | stainless steel | data output RB5 (only up to 500 mm) | box



10-162

Art.-Nr. Order no.	Messbereich Range	Brückenlänge Length of base	Haken hooks	EUR
10-162	200 mm	100 mm	5x2 mm	68,50
10-163	300 mm			92,50
10-164	500 mm	120 mm	8x3 mm	193,00
10-165	1000 mm	250 mm	10x4 mm	484,00

Messschieber Calipers

Digital-Tiefenmessschieber mit **Doppelhaken** *Digital depth caliper with double hooks*

Auflösung 0,01 mm / 0,0005 inch | Metallgehäuse | DIN 862 | rostfreier Stahl | Datenausgang RB5 | Aufbewahrungsbox
 Reading 0.01 mm / 0.0005 inch | metal housing | DIN 862 | stainless steel | data output RB5 | box



Art.-Nr. Order no.	Messbereich Range	Brückenlänge Length of base	EUR
10-167	200 mm	100 mm	86,50

HELIOS-PREISSER Digital-Tiefenmessschieber mit **Doppelhaken** *Digital depth caliper with double hooks*

Auflösung 0,01 mm / 0,0005 inch | Genauigkeit 0,03 mm | rostfreier Stahl | wasserdicht gemäß IP67 | variabler Datenausgang RS232 / Digimatic / USB | Holz-Aufbewahrungsbox
 Reading 0.01 mm / 0.0005 inch | accuracy 0.03 mm | stainless steel | waterproof according to IP67 | variable data output RS232 / Digimatic / USB | wooden box



Art.-Nr. Order no.	Messbereich Range	Brückenlänge Length of base	EUR
46-281	200 mm	100 mm	414,00
46-282	300 mm	150 mm	498,00
46-283	500 mm	150 mm	629,00

Anwendungsbeispiel:
Example of use:

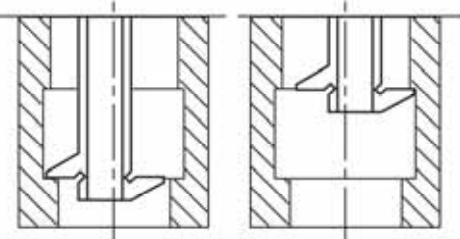

Informationen und Zubehör zum Thema Datenübertragung finden Sie in Kapitel 15!
 Information and accessories related to data transfer can be found in chapter 15!

HELIOS-PREISSER Digital-Tiefenmessschieber mit **wechselbaren Einsätzen** *Digital depth caliper with changeable inserts*

Auflösung 0,01 mm / 0,0005 inch | inkl. 3 wechselbaren Messeinsätzen: Teller Ø7,5x1 mm, Plan Ø4 mm, Sphärisch Ø4 mm | Genauigkeit 0,02 mm | rostfreier Stahl | wasserdicht gemäß IP67 | variabler Datenausgang RS232 / Digimatic / USB | Preset-Funktion (Messwertvoreinstellung) | Zählrichtungsumkehr | Aufbewahrungsbox
 Reading 0.01 mm / 0.0005 inch | incl. 3 changeable measuring inserts: Disc Ø7.5x1 mm, plane Ø4 mm, spherical Ø4 mm | accuracy 0.02 mm | stainless steel | waterproof according to IP67 | variable data output RS232 / Digimatic / USB | Preset-Function | inversion of counting direction | box



Art.-Nr. Order no.	Messbereich Range	Brückenlänge Length of base	Messstange Rod	EUR
46-298	100 mm	85 mm	Ø4 mm	498,00

Anwendungsbeispiele
Examples of use

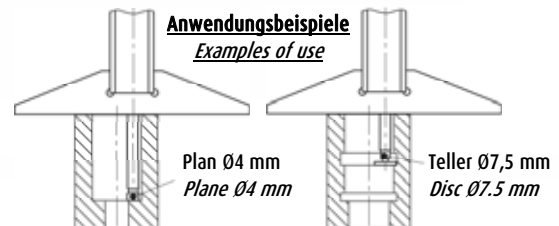

Informationen und Zubehör zum Thema Datenübertragung finden Sie in Kapitel 15!
 Information and accessories related to data transfer can be found in chapter 15!

Messschieber Calipers

Digital-Tiefenmessschieber mit Prisma-Messbrücke (Keilnuten-Messschieber) Digital depth caliper with prism base

Auflösung 0,01 mm / 0,0005 inch | Messstift Ø1,5 mm | Brückenlänge 100 mm | Genauigkeit 0,04 mm | rostfreier Stahl | Datenausgang RB5 | Aufbewahrungsbox

Reading 0.01 mm / 0.0005 inch | measuring pin Ø1.5 mm | length of base 100 mm | accuracy 0.04 mm | stainless steel | data output RB5 | box

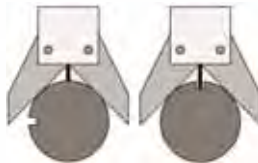

Art.-Nr. Order no.	Messbereich Range	Öffnungswinkel angle	für Wellen for shafts	EUR
10-191	50 mm	90°	Ø5-140 mm	68,50
10-192		120°	Ø5-200 mm	68,50

Digital-Tiefenmessschieber für 90°-Senkungen Digital depth caliper for abatements of 90°

Auflösung 0,01 mm / 0,0005 inch | Brückenlänge 50 mm | Genauigkeit 0,1 mm | rostfreier Stahl | Datenausgang RB5 | Aufbewahrungsbox

Reading 0.01 mm / 0.0005 inch | length of base 50 mm | accuracy 0.1 mm | stainless steel | data output RB5 | box

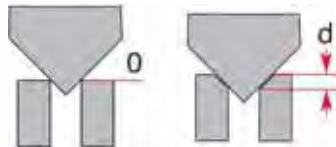

Art.-Nr. Order no.	Messbereich Range	EUR
10-194	12 mm	88,00

Zubehör für Datenübertragung Accessories for data transfer

Für alle Messschieber mit Datenausgang RB5 | am Messschieber angezeigter Messwert wird einfach per Tastendruck an einen PC (Windows 10) übertragen und direkt in ein Messprotokoll, CAQ-System, Excel-Tabelle o. ä. eingefügt | verschiedene Optionen einstellbar | Auflösung 0,01 mm

For all calipers with data output RB5 | displayed value from caliper is simply transferred by keystroke to a PC (Windows 10) into a measurement report, CAQ-system or Excel table, etc. | various options adjustable | resolution 0.01 mm



Art.-Nr. Order no.	Artikel Range	EUR
10-981	USB-Interface (2,4 m)	108,00
10-991	Anschlußkabel RB5 (1 m) Connection cable RB5	13,50

Anbau-Messbrücke für Digital-Tiefenmessschieber Extension base for digital depth caliper

Aufnahme: mittig (10-188), mittig/außermittig (10-189-2) | rostfreier Stahl | nicht geeignet für Digital-Tiefenmessschieber „Light-Line“

Fixation: centric (10-188), centric/eccentric (10-189-2) | stainless steel | not suitable for digital depth calipers "Light-Line"

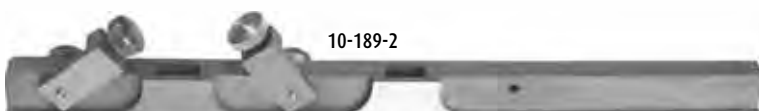

Art.-Nr. Order no.	Brückenlänge Length of base	Aufnahme seat	EUR
10-188	200 mm	15x6 mm	34,80
10-189-2	300 mm	(2x) 17x7 mm	46,50

Messschieber Calipers

Digital-Einbaumessschieber **horizontal** *Digital scale unit horizontal*

Auflösung 0,01 mm / 0,0005 inch | DIN 862 | rostfreier Stahl | Datenausgang RB5 (nur bis 400 mm)
 Reading 0.01 mm / 0.0005 inch | DIN 862 | stainless steel | data output RB5 (only up to 400 mm)

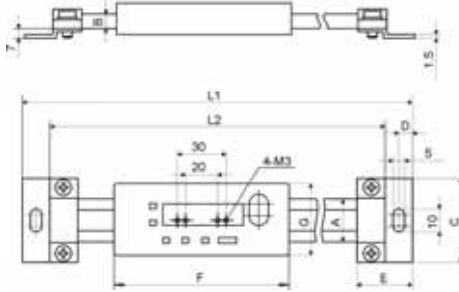

Art.-Nr. Order no.	Messbereich Range	A (mm)	B (mm)	C (mm)	D (mm)	E (mm)	F (mm)	G (mm)	L1 (mm)	L2 (mm)	EUR
10-401	100 mm	16	4	36	6	24	66	37	217	193	41,50
10-402	150 mm	16	4	36	6	25	66	37	267	242	43,50
10-403	200 mm	16	4	36	6	25	66	37	320	293	56,00
10-404	300 mm	16	4	36	6	25	66	37	446	419	85,50
10-405	400 mm	16	4	36	6	25	66	37	550	523	109,00
10-406	500 mm	24	5,5	45	8	32	99	40	685	655	155,00
10-407	600 mm	24	5,5	45	8	32	99	40	785	755	193,00
10-408	800 mm	24	5,5	45	8	40	99	75	982	950	271,00
10-409	1000 mm	31	10,5	60	10	40	129	75	1245	1207	382,00



≤ 400 mm



≥ 500 mm

Digital-Einbaumessschieber **vertikal** *Digital scale unit vertical*

Auflösung 0,01 mm / 0,0005 inch | DIN 862 | rostfreier Stahl | Datenausgang RB5
 Reading 0.01 mm / 0.0005 inch | DIN 862 | stainless steel | data output RB5



10-411

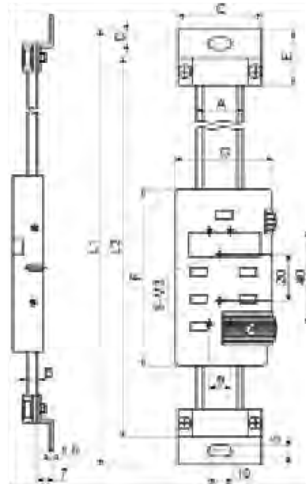

Abmessungen: *dimensions:*

- A = 20 mm
- B = 4 mm
- C = 40 mm
- D = 6 mm
- E = 24 mm
- F = 80 mm
- G = 45 mm

Art.-Nr. Order no.	Messbereich Range	L1 (mm)	L2 (mm)	EUR
10-411	100 mm	248	223	61,00
10-412	150 mm	298	275	64,50
10-413	200 mm	346	322	72,50
10-414	300 mm	448	424	107,00
10-415	400 mm	546	525	133,00
10-416	500 mm	685	655	164,00

Messschieber Calipers

HELIOS-PREISSER Digital-Einbaumessschieber **horizontal** Digital scale unit horizontal

Auflösung 0,01 mm / 0,0005 inch | Datenausgang Opto RS232 | Schiene aus rostfreiem Stahl | Preset-Funktion
(Messwertvoreinstellung)

Reading 0.01 mm / 0.0005 inch | data output Opto RS232 | bar from stainless steel | Preset function

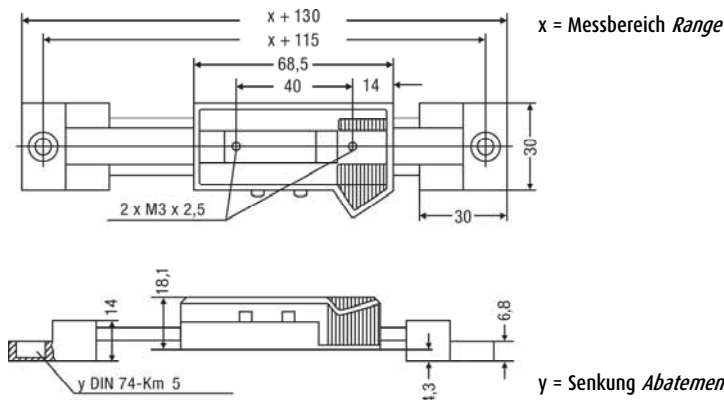

Art.-Nr. Order no.	Messbereich Range	Genauigkeit Accuracy	EUR
47-001	150 mm	0,03 mm	199,00
47-002	200 mm		208,00
47-003	300 mm		225,00
47-004	450 mm		238,00
47-005	600 mm		289,00
47-006	800 mm	0,04 mm	506,00
47-007	1000 mm		551,00



HELIOS-PREISSER Digital-Einbaumessschieber **vertikal** Digital scale unit vertical

Auflösung 0,01 mm / 0,0005 inch | Datenausgang Opto RS232 | Schiene aus rostfreiem Stahl | Preset-Funktion (Messwertvoreinstellung)

Reading 0.01 mm / 0.0005 inch | data output Opto RS232 | bar from stainless steel | Preset function

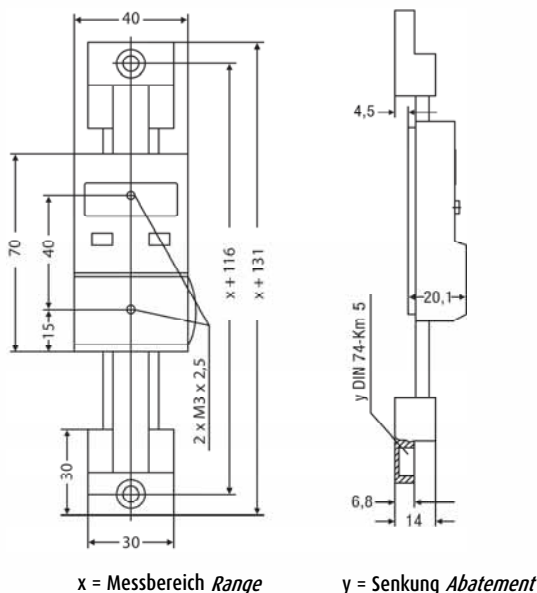

Art.-Nr. Order no.	Messbereich Range	Genauigkeit Accuracy	EUR
47-011	150 mm	0,03 mm	359,00
47-012	200 mm		366,00
47-013	300 mm		388,00
47-014	450 mm		409,00
47-015	600 mm		439,00
47-016	800 mm	0,04 mm	617,00
47-017	1000 mm		663,00

VOGEL Digitales Entfernungs- und Positionierungs-Messsystem mit VGA-Zoom-Kamera
Digital distance and positioning measuring system with VGA-zoom-camera

Auflösung 0,01 mm / 0,0005 inch | Stahlschiene rostfrei und gehärtet | Füße mit Magneteinsätzen, rutschfeste Gummikappen und Positionspfeilen | großes 3,5"-Farbdisplay (720 Pixel) mit Fadenkreuz und 10fach-Zoom-Funktion | Fokus manuell einstellbar | 4 GB Mikro-SD-Karte (Video-Format AVI, Foto-Format JPG) | Mini-USB-Anschluss für Ladekabel | umschaltbare LED-Beleuchtung: Weißlicht oder UV-/Schwarz-Licht | Schutzklasse IP54 | inkl. Hersteller-Kalibrierzertifikat
Reading 0.01 mm / 0.0005 inch | steel guide rail stainless and hardened | feet with magnetic inserts, anti-slip rubber cap and positioning arrow | large 3.5" color display (720 pixel) with cross lines and 10x zoom | focal point manually adjustable | 4 GB micro-SD-card (video file format AVI, photo file format JPG) | Mini USB interface for charging cable | switchable LED illumination: white light or UV/black light | protection class IP54 | manufacturers calibration certificate included



Art.-Nr. Order no.	Messbereich Range	Gesamtlänge Overall length	Genauigkeit Accuracy	EUR
44-071	135 mm	275 mm		1665,00
44-072	185 mm	325 mm	0,03 mm	1765,00
44-073	285 mm	425 mm		1860,00
44-074	480 mm	625 mm	0,04 mm	1960,00

Zubehör für Datenübertragung (für Windows 10):
Accessories for data transfer (for Windows 10):



Art.-Nr. Order no.	Beschreibung Description	EUR
44-077	WiFi-Funkmodul (Sender+Empfänger) <i>WiFi radio module (sender+receiver)</i>	139,00
44-078	Bluetooth USB-Empfänger <i>Bluetooth USB receiver</i>	27,50
44-079	Bluetooth-Sender <i>Bluetooth sender</i>	52,00

Messschrauben

Micrometer



Inhalt Contents



02.2



02.6



02.12



02.13



02.20

Normen Standards

Alle unsere Messschrauben nach DIN 863 erfüllen folgende Werte:

All our micrometers according to DIN 863 comply with following values:

Messbereich (mm) Range (mm)	0-25	25-50	50-75	75-100	100-125	125-150	150-175	175-200	200-225	225-250	-300	-400	-500
Genauigkeit* Accuracy	±0,004	±0,004	±0,005	±0,005	±0,006	±0,006	±0,007	±0,007	±0,008	±0,008	±0,009	±0,011	±0,013

*Fehlergrenze G in mm

Weitere Informationen: siehe DIN 863 (DIN Deutsches Institut für Normung e. V., erschienen im Beuth Verlag)

Further information: see DIN 863 (DIN Deutsches Institut für Normung e. V., published by Beuth Verlag)

Kalibrierung Calibration

Informationen zur Kalibrierung erhalten Sie in Kapitel 15!

Information about calibration can be found in chapter 15!

Messschrauben Micrometers

Bügelmessschraube *Micrometer*

Ablesung 0,01 mm | Spindel Ø6,5 mm | DIN 863 | Bügel blau lackiert | Ablese-
teile mattverchromt | Hartmetall-Messflächen | Aufbewahrungsbox |
ab Messbereich 25-50 mm mit Einstellmaß

*Reading 0.01 mm | spindle Ø6.5 mm | DIN 863 | frame lacquered blue | satin chrome finished | carbide measuring faces | box |
from Range 25-50 mm with setting dimension*



Art.-Nr. Order no.	Messbereich Range	EUR	Art.-Nr. Order no.	Messbereich Range	EUR
11-401	0-25 mm	19,50	11-407	150-175 mm	44,50
11-402	25-50 mm	22,50	11-408	175-200 mm	47,50
11-403	50-75 mm	25,00	11-409	200-225 mm	57,00
11-404	75-100 mm	27,50	11-410	225-250 mm	63,00
11-405	100-125 mm	34,50	11-411	250-275 mm	68,50
11-406	125-150 mm	38,50	11-412	275-300 mm	73,50

Bügelmessschrauben im Satz *Micrometers in set*

Ablesung 0,01 mm | Spindel Ø6,5 mm | DIN 863 | Ablese-
teile mattverchromt | Hartmetall-Messflächen | mit Einstellmaßen | Aufbewahrungsbox
Reading 0.01 mm | spindle Ø6.5 mm | DIN 863 | satin chrome finished | carbide measuring faces | with setting dimensions | box



11-421

Art.-Nr. Order no.	Messbereich Range	Anzahl quantity	EUR
11-421	0-100 mm	4	99,00
11-426	0-150 mm	6	169,00
11-427	0-300 mm	12	553,00

HELIOS-PREISSER Bügelmessschraube *Micrometer*

Ablesung 0,01 mm | Spindel Ø6,5 mm | DIN 863 | Bügel mit Handwärmeschutz | Ablese-
teile mattverchromt | Hartmetall-Messflächen | Aufbewahrungsbox | ab Messbereich 25-50 mm mit Einstellmaß

*Reading 0.01 mm | spindle Ø6.5 mm | DIN 863 | frame with protection of hand heat | satin chrome finished |
carbide measuring faces | box | from Range 25-50 mm with setting dimension*



46-311

Art.-Nr. Order no.	Messbereich Range	EUR	Art.-Nr. Order no.	Messbereich Range	EUR
46-311	0-25 mm	44,80	46-315	100-125 mm	139,00
46-312	25-50 mm	72,50	46-316	125-150 mm	157,00
46-313	50-75 mm	89,50	46-317	150-175 mm	174,00
46-314	75-100 mm	103,00	46-318	175-200 mm	192,00



HELIOS-PREISSER Bügelmessschrauben im Satz *Micrometers in set*

Ablesung 0,01 mm | Spindel Ø6,5 mm | DIN 863 | Bügel mit Handwärmeschutz | Ablese-
teile mattverchromt | Hartmetall-Messflächen | Aufbewahrungsbox | mit Einstellmaßen

*Reading 0.01 mm | spindle Ø6.5 mm | DIN 863 |
frame with protection of hand heat | satin chrome finished |
carbide measuring faces | box | with setting dimensions*



46-319

Art.-Nr. Order no.	Messbereich Range	Anzahl quantity	EUR
46-319	0-100 mm	4	269,00
46-320	100-200 mm	4	593,00



Messschrauben

Micrometers

Bügelmessschraube klein *Small Micrometer*

Ablesung 0,01 mm | Spindel Ø5,0 mm | Gesamtlänge ca. 72 mm | Ableseteile mattverchromt | ohne Ratsche | Aufbewahrungsbox
Reading 0.01 mm | spindle Ø5.0 mm | Overall length approx. 72 mm | satin chrome finished | without ratchet | box



Art.-Nr. Order no.	Messbereich Range	EUR
11-010	0-15 mm	27,50

Bügelmessschraube mit großer Trommel *Micrometer with large thimble*

Ablesung 0,01 mm | Spindel Ø8,0 mm | DIN 863 | Ableseteile mattverchromt | Hartmetall-Messflächen | Aufbewahrungsbox | ab Messbereich 25-50 mm mit Einstellmaß
Reading 0.01 mm | spindle Ø8.0 mm | DIN 863 | satin chrome finished | carbide measuring faces | box | from Range 25-50 mm with setting dimension



Art.-Nr. Order no.	Messbereich Range	EUR
11-031	0-25 mm	54,50
11-032	25-50 mm	59,00
11-033	50-75 mm	69,00
11-034	75-100 mm	74,50

Bügelmessschraube mit Zählwerk *Micrometer with counter*

Ablesung 0,01 mm | Spindel Ø6,5 mm | DIN 863 | Ableseteile mattverchromt | Hartmetall-Messflächen | Aufbewahrungsbox | ab Messbereich 25-50 mm mit Einstellmaß
Reading 0.01 mm | spindle Ø6.5 mm | DIN 863 | satin chrome finished | carbide measuring faces | box | from Range 25-50 mm with setting dimension



Art.-Nr. Order no.	Messbereich Range	EUR
11-061	0-25 mm	49,50
11-062	25-50 mm	56,00
11-063	50-75 mm	63,50
11-064	75-100 mm	69,50

Linkshänder-Bügelmessschraube *Micrometer for left hand use*

Ablesung 0,01 mm | Spindel Ø6,5 mm | DIN 863 | Ableseteile mattverchromt | Hartmetall-Messflächen | Aufbewahrungsbox
Reading 0.01 mm | spindle Ø6.5 mm | DIN 863 | satin chrome finished | carbide measuring faces | box



Art.-Nr. Order no.	Messbereich Range	EUR
11-011	0-25 mm	29,80

01

02

03

04

05

06

07

08

09

10

11

12

13

14

15

Messschrauben Micrometers

Bügelmessschraube mit großer Ablesescheibe *Micrometer with large disc for reading*



Ablesung 0,01 mm | Spindel Ø6,5 mm | Genauigkeit 0,04 mm | Bügeltiefe 50 mm |
Hartmetall-Messflächen | Aufbewahrungsbox
*Reading 0.01 mm | spindle Ø6.5 mm | Accuracy 0.04 mm | frame depth 50 mm | carbide
measuring faces | box*

Art.-Nr. Order no.	Messbereich Range	EUR
11-071	0-15 mm	96,50
11-072	0-25 mm	115,00

Bügelmessschraube mit großer Bügeltiefe *Micrometer with large frame depth*



Ablesung 0,01 mm | Bügeltiefe 100 mm | Spindel Ø6,5 mm | DIN 863 |
Ableseeteile mattverchromt | Hartmetall-Messflächen |
Aufbewahrungsbox | Messbereich 25-50 mm mit Einstellmaß
*Reading 0.01 mm | frame depth 100 mm | spindle Ø6.5 mm | DIN
863 | satin chrome finished | carbide measuring faces | box | Range
25-50 mm with setting dimension*

Art.-Nr. Order no.	Messbereich Range	EUR
11-091	0-25 mm	86,50
11-092	25-50 mm	99,00

HELIOS-PREISSER Bügelmessschraube mit großer Bügeltiefe *Micrometer with large frame depth*

Ablesung 0,01 mm | DIN 863 | Spindelsteigung 1 mm | Trommel Ø24 mm | Ableseeteile mattverchromt | Hartmetall-
Messflächen | Made in Germany | Holz-Aufbewahrungsbox
*Reading 0.01 mm | DIN 863 | spindle pitch 1 mm | thimble Ø24 mm | satin chrome finished | carbide measuring
faces | Made in Germany | wooden box*



Art.-Nr. Order no.	Messbereich Range	Bügeltiefe Depth of frame	EUR
46-301	0-25 mm	100 mm	285,00
46-302		150 mm	299,00
46-303		250 mm	375,00
46-304	0-50 mm	50 mm	314,00
46-305		100 mm	477,00
46-306	50-100 mm	100 mm	528,00

Messschrauben Micrometers

Bügelmessschraube mit Feinzeiger *Indicating snap micrometer*

Ablesung 0,001 mm | Spindel Ø6,5 mm | Feinzeiger Messbereich ±0,04 mm | Genauigkeit Messschraube 0,003 mm, Genauigkeit Feinzeiger 0,002 mm | einstellbarer Tiefenanschlag | Ablesteile mattverchromt | Hartmetall-Messflächen | Aufbewahrungsbox | ab Messbereich 25-50 mm mit Einstellmaß
Reading 0.001 mm | spindle Ø6.5 mm | Indicator range ±0.04 mm | Accuracy micrometer 0.003 mm, accuracy indicator 0.002 mm | adjustable depth stop | satin chrome finished | carbide measuring faces | box | from Range 25-50 mm with setting dimension



11-081

Art.-Nr. Order no.	Messbereich Range	EUR
11-081	0-25 mm	238,00
11-082	25-50 mm	287,00
11-083	50-75 mm	316,00
11-084	75-100 mm	381,00

HELIOS-PREISSER Feinzeigermessschraube *Indicating snap micrometer*

Ablesung 0,01 mm, Ablesung Feinzeiger 0,001 mm | Spindel Ø7,5 mm | Feinzeiger Messbereich ±0,05 mm | DIN 863 | Bügel mit Handwärmeschutz | Ablesteile mattverchromt | Hartmetall-Messflächen | Made in Germany | Aufbewahrungsbox

Reading 0.01 mm, reading indicator 0.001 mm | spindle Ø7.5 mm | Indicator range ±0.05 mm | DIN 863 | frame with protection of hand heat | satin chrome finished | carbide measuring faces | Made in Germany | box



46-341



Art.-Nr. Order no.	Messbereich Range	EUR
46-341	0-25 mm	569,00
46-342	25-50 mm	633,00
46-343	50-100 mm	673,00
46-344	100-150 mm	719,00
46-345	150-200 mm	753,00

Limit-Bügelmessschraube (Doppel-Bügelmessschraube) *Limit micrometer*

Einsatz als Gut/Ausschuß-Lehre durch Einstellung von oberer und unterer Toleranzgrenze | Ablesung 0,002 mm | Spindel Ø6,5 mm | Spindelabstand 20 mm | DIN 863 | Ablesteile mattverchromt | Hartmetall-Messflächen | Aufbewahrungsbox | Messbereich 25-50 mm mit Einstellmaß

Use as GO/NOGO gauge by setting upper and lower limit | Reading 0.002 mm | spindle Ø6.5 mm | Distance between spindles 20 mm | DIN 863 | satin chrome finished | carbide measuring faces | box | Range 25-50 mm with setting dimension



11-098

Art.-Nr. Order no.	Messbereich Range	EUR
11-098	0-25 mm	99,00
11-099	25-50 mm	124,00

Ratschen-Kraftmessgerät für Bügelmessschrauben *Ratchet force measuring tool for micrometers*

Zur Prüfung der Messkraft von Messschrauben-Ratschen | Messbereich 5-12 N | mit Verlängerungen für Messschrauben bis 100 mm
For measuring force of micrometer ratchet | Range 5-12 N | with extensions for micrometers up to 100 mm



Art.-Nr. Order no.	EUR
11-199	36,00

Messschrauben Micrometers

Halter für Bügelmessschrauben *Holder for micrometer*

für Messbereich bis 300 mm | Neigung stufenlos einstellbar |
rutschhemmende GummifüÙe | Gewicht 2000 g
*for range up to 300 mm | inclination continuously adaptable |
anti-skid rubber base | weight 2000 g*

Art.-Nr. Order no.	EUR
11-191	19,50



für Messbereich bis 100 mm | Neigung stufenlos einstellbar | Gewicht 750 g
for range up to 100 mm | inclination continuously adaptable | weight 750 g

Art.-Nr. Order no.	EUR
11-196	23,50



HELIOS-PREISSER Halter für Bügelmessschrauben *Holder for micrometer*

für Messbereich bis 300 mm | Gewicht ca. 1,8 kg | mit schwerem
Gussfuß | vertikal dreh- und feststellbar
*for range up to 300 mm | weight approx. 1.8 kg | with heavy base
of cast iron | vertically rotatable and lockable*



Art.-Nr. Order no.	EUR
46-348	54,50

Bügelmessschraube mit auswechselbaren Ambossen *Micrometer with changeable anvils*



Ablesung 0,01 mm | Spindel Ø8,0 mm | Ableseteile mattverchromt | Hartmetall-
Messflächen | inkl. EinstellmaÙe | Aufbewahrungsbox
*Reading 0.01 mm | spindle Ø8.0 mm | satin chrome finished | carbide measuring
faces | with setting dimensions | box*



Art.-Nr. Order no.	Messbereich Range	Genauigkeit Accuracy	EUR
11-041	0-100 mm	0,009 mm	139,00
11-042	0-150 mm	0,011 mm	172,00
11-043	100-200 mm	0,011 mm	198,00
11-044	200-300 mm	0,013 mm	213,00

Messschrauben Micrometers

Bügelmessschraube mit Messbereich bis 2000 mm *Micrometer for ranges up to 2000 mm*

Ablesung 0,01 mm | Spindel Ø8,0 mm | Ableseteile mattverchromt | Hartmetall-Messflächen | Einstellmaß | ab 1000 mm mit großer Trommel
Reading 0.01 mm | spindle Ø8.0 mm | satin chrome finished | carbide measuring faces | with setting dimensions | from 1000 mm with large thimble

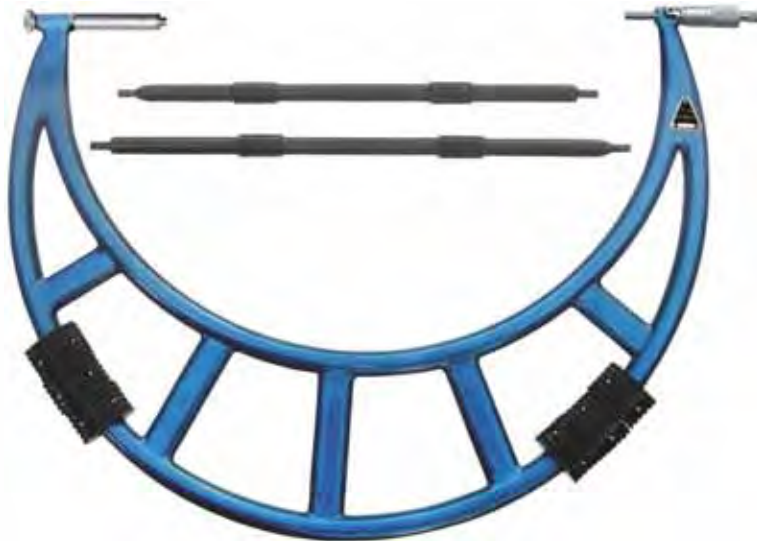

Art.-Nr. Order no.	Messbereich Range	Genauigkeit Accuracy	EUR
11-045	300-400 mm	0,011 mm	269,00
11-046	400-500 mm	0,013 mm	308,00
11-047	500-600 mm	0,015 mm	365,00
11-048	600-700 mm	0,016 mm	458,00
11-049	700-800 mm	0,018 mm	522,00
11-050	800-900 mm	0,020 mm	619,00
11-051	900-1000 mm	0,020 mm	683,00
11-509	1000-1200 mm	0,020 mm	1469,00
11-510	1200-1400 mm	0,024 mm	1575,00
11-511	1400-1600 mm	0,028 mm	1680,00
11-512	1600-1800 mm	0,031 mm	1855,00
11-513	1800-2000 mm	0,034 mm	2140,00

HELIOS-PREISSER Bügelmessschraube mit Messbereich bis 1500 mm *Micrometer for ranges up to 1500 mm*

Ablesung 0,01 mm | Spindel Ø10,0 mm | DIN 863 | Ableseteile mattverchromt | Hartmetall-Messflächen |
 Spindelverstellung 50 mm | aufschraubbarer Wechselamboss 50 mm | Made in Germany | Holzetui
*Reading 0.01 mm | spindle Ø10.0 mm | DIN 863 | satin chrome finished | carbide measuring faces |
 range of spindle 50 mm | changeable anvil 50 mm | Made in Germany | wooden box*



Art.-Nr. Order no.	Messbereich Range	Genauigkeit Accuracy	EUR
46-321	200-300 mm	0,006 mm	1095,00
46-322	300-400 mm	0,007 mm	1140,00
46-323	400-500 mm	0,008 mm	1280,00
46-324	500-600 mm	0,009 mm	1450,00
46-325	600-700 mm	0,009 mm	1620,00
46-326	700-800 mm	0,009 mm	1795,00
46-327	800-900 mm	0,010 mm	1980,00
46-328	900-1000 mm	0,010 mm	2190,00

Messschrauben Micrometers

Bügelmessschraube zur Nutenmessung *Blade micrometer for measuring grooves*

Ablesung 0,01 mm | Spindel Ø6,5 mm, nichtdrehend | Messfläche 0,75x6,5 mm | DIN 863 | Ableseile mattverchromt | Aufbewahrungsbox | ab Messbereich 25-50 mm mit Einstellmaß

Reading 0.01 mm | spindle Ø6.5 mm, non-rotating | measuring face 0.75x6.5 mm | DIN 863 | satin chrome finished | box | from Range 25-50 mm with setting dimension



Art.-Nr. Order no.	Messbereich Range	EUR
11-101	0-25 mm	135,00
11-102	25-50 mm	148,00
11-103	50-75 mm	159,00
11-104	75-100 mm	177,00
11-105	100-125 mm	195,00
11-106	125-150 mm	208,00

HELIOS-PREISSER Bügelmessschraube zur Nutenmessung *Blade micrometer for measuring grooves*

Ablesung 0,01 mm | Spindel Ø8 mm, nichtdrehend | Messfläche 0,8x7 mm | DIN 863 | Ableseile mattverchromt | Aufbewahrungsbox | ab Messbereich 25-50 mm mit Einstellmaß

Reading 0.01 mm | spindle Ø8 mm, non-rotating | measuring face 0.8x7 mm | DIN 863 | satin chrome finished | box | from Range 25-50 mm with setting dimension



Art.-Nr. Order no.	Messbereich Range	EUR
46-351	0-25 mm	249,00
46-352	25-50 mm	306,00
46-353	50-75 mm	328,00
46-354	75-100 mm	356,00

Bügelmessschraube mit kleiner Messfläche *Micrometer with small measuring face*

Ablesung 0,01 mm | Spindel Ø6,5 mm | Messfläche Ø2x5 mm | DIN 863 | Ableseile mattverchromt | Hartmetall-Messflächen | Aufbewahrungsbox

Reading 0.01 mm | spindle Ø6.5 mm | measuring face Ø2x5 mm | DIN 863 | satin chrome finished | carbide measuring face | box



Art.-Nr. Order no.	Messbereich Range	EUR
11-161	0-25 mm	67,50
11-162*	25-50 mm	79,50

*inkl. Einstellmaß
with setting dimension

HELIOS-PREISSER Bügelmessschraube mit kleiner Messfläche *Micrometer with small measuring face*

Ablesung 0,01 mm | Spindel Ø6,5 mm | Messfläche Ø3x8,5 mm | DIN 863 | Ableseile mattverchromt | Hartmetall-Messflächen | Aufbewahrungsbox | ab Messbereich 25-50 mm mit Einstellmaß

Reading 0.01 mm | spindle Ø6.5 mm | measuring face Ø3x8.5 mm | DIN 863 | satin chrome finished | carbide measuring face | box | from Range 25-50 mm with setting dimension



Art.-Nr. Order no.	Messbereich Range	EUR
46-356	0-25 mm	179,00
46-357	25-50 mm	223,00
46-358	50-75 mm	252,00
46-359	75-100 mm	267,00

Messschrauben Micrometers

Bügelmessschraube mit Tellermessflächen *Disc micrometer*

Ablesung 0,01 mm | Spindel Ø6,5 mm, nichtdrehend | Ablese­teile mattverchromt | Aufbewahrungsbox | ab Messbereich 25-50 mm mit Einstellmaß
Reading 0.01 mm | spindle Ø6.5 mm, non-rotating | satin chrome finished | box | from range 25-50 mm with setting dimension



Art.-Nr. Order no.	Messbereich Range	Teller disc	Genauigkeit Accuracy	EUR
11-111	0-25 mm	Ø20 mm	0,004 mm	78,50
11-112	25-50 mm			89,00
11-113	50-75 mm		Ø30 mm	0,005 mm
11-114	75-100 mm	113,00		
11-115	100-125 mm	0,006 mm		
11-116	125-150 mm			145,00
11-117	150-175 mm	0,007 mm		0,007 mm
11-118	175-200 mm		175,00	

HELIOS-PREISSER Bügelmessschraube mit Tellermessflächen *Disc Micrometer*

Ablesung 0,01 mm | Spindel Ø6,5 mm, nichtdrehend | Ablese­teile mattverchromt | Aufbewahrungsbox
Reading 0.01 mm | spindle Ø6.5 mm, non-rotating | satin chrome finished | box



Art.-Nr. Order no.	Messbereich Range	Teller disc	Genauigkeit Accuracy	EUR
46-361	0-25 mm	Ø25 mm	0,004 mm	324,00
46-362	25-50 mm			388,00
46-363	50-75 mm		0,005 mm	421,00
46-364	75-100 mm			457,00
46-365	100-125 mm		0,006 mm	483,00
46-366	125-150 mm			529,00
46-367	150-175 mm		0,007 mm	568,00
46-368	175-200 mm			599,00

Bügelmessschraube zur Drahtmessung *Wire micrometer*

für Draht- und Kugelmessung | Ablesung 0,01 mm | Spindel Ø6,5 mm | Hartmetall-Messflächen | Ablese­teile mattverchromt | Aufbewahrungsbox
for wire and ball measuring | Reading 0.01 mm | spindle Ø6.5 mm | carbide measuring face | satin chrome finished | box



Art.-Nr. Order no.	Messbereich Range	Genauigkeit Accuracy	EUR
11-109	0-10 mm	0,004 mm	79,50

3/5-Punkt-Bügelmessschraube für Dreikant-/Fünfkant-Werkstücke *3/5-point micrometer for 3-edged/5-edged parts*

Ablesung 0,01 mm | Spindel Ø6,5 mm | mit Hartmetall-Prisma | Ablese­teile mattverchromt | mit Einstellmaß | Aufbewahrungsbox
Reading 0.01 mm | spindle Ø6.5 mm | with carbide prism | satin chrome finished | with setting dimension | box



Art.-Nr. Order no.	Messbereich Range	Punkte points	Genauigkeit Accuracy	EUR
11-151*	1-15 mm	3	0,005 mm	156,00
11-152	5-20 mm			164,00
11-153	20-35 mm		5	0,006 mm
11-481	5-25 mm	0,005 mm		168,00
11-482	25-45 mm		199,00	



*Nur 11-151: kegelige Spindelspitze
Only 11-151: conical spindle

Messschrauben

Micrometers

Bügelmessschraube für Rohrwanddickenmessung Tube Micrometer

ballig/plan | Ablesung 0,01 mm | Spindel Ø6,5 mm | Genauigkeit 0,004 mm | Ableseteile mattverchromt | Aufbewahrungsbox
spherical/flat | reading 0.01 mm | spindle Ø6.5 mm | accuracy 0.004 mm | satin chrome finished | box



Art.-Nr. Order no.	Messbereich Range	EUR
11-166	0-25 mm	39,50

Stift/plan | Ablesung 0,01 mm | Spindel Ø6,5 mm | Genauigkeit 0,004 mm | Stift Ø1,8 mm | Ableseteile mattverchromt | Aufbewahrungsbox
pin/flat | reading 0.01 mm | spindle Ø6.5 mm | accuracy 0.004 mm | pin Ø1.8 mm | satin chrome finished | box



Art.-Nr. Order no.	Messbereich Range	EUR
11-167	0-25 mm	46,50

kugelig/plan | Ablesung 0,01 mm | Spindel Ø6,5 mm | Genauigkeit 0,004 mm | Kugel Ø4,7 mm | Ableseteile mattverchromt | Aufbewahrungsbox
ball/flat | reading 0.01 mm | spindle Ø6.5 mm | accuracy 0.004 mm | ball Ø4.7 mm | satin chrome finished | box



Art.-Nr. Order no.	Messbereich Range	EUR
11-168	0-25 mm	44,50

ballig/ballig | Ablesung 0,01 mm | Spindel Ø6,5 mm | Genauigkeit 0,004 mm | Ableseteile mattverchromt | Aufbewahrungsbox
spherical/spherical | reading 0.01 mm | spindle Ø6.5 mm | accuracy 0.004 mm | satin chrome finished | box



Art.-Nr. Order no.	Messbereich Range	EUR
11-169	0-25 mm	44,50

HELIOS-PREISSER Bügelmessschraube für Rohrwanddickenmessung Tube Micrometer

Ablesung 0,01 mm | Spindel Ø6,5 mm | DIN 863 | Ableseteile mattverchromt | Aufbewahrungsbox
 Reading 0.01 mm | spindle Ø6.5 mm | DIN 863 | satin chrome finished | box



Art.-Nr. Order no.	Messbereich Range	Kugel ball	EUR
46-369	0-15 mm	Ø2,5 mm	189,00
46-370	0-25 mm	Ø6,5 mm	191,00

Messschrauben Micrometers

Bügelmessschraube mit **auswechselbaren Einsätzen** *Micrometer with changeable inserts*

Ablesung 0,01 mm | Spindel Ø8 mm, nichtdrehend | Aufnahme für Einsätze Ø5 mm | Ableseteile mattverchromt | Box | inklusive 7 Paar Messeinsätze | ab Messbereich 25-50 mm mit Einstellmaß
Reading 0.01 mm | spindle Ø6.5 mm, non-rotating | for inserts with shaft Ø5 mm | satin chrome finished | box | incl. 7 pairs of inserts | from range 25-50 mm with setting dimension

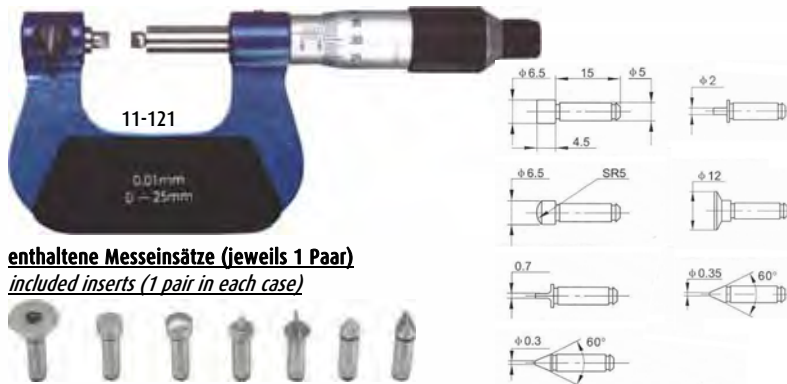

enthaltene Messeinsätze (jeweils 1 Paar)
included inserts (1 pair in each case)



Art.-Nr. Order no.	Messbereich Range	Genauigkeit Accuracy	EUR
11-121	0-25 mm	0,008 mm	199,00
11-122	25-50 mm		218,00
11-123	50-75 mm	0,010 mm	229,00
11-124	75-100 mm		248,00
11-124-1	100-125 mm	0,012 mm	269,00
11-124-2	125-150 mm		288,00
11-124-3	150-175 mm	0,014 mm	299,00
11-124-4	175-200 mm		311,00

Ersatz-Messeinsätze: siehe Seite 01.24
Inserts as spare parts: see page 01.24

Bügelmessschraube für **Gewindemessung** *Screw micrometer*

Ablesung 0,01 mm | Spindel Ø8 mm, nichtdrehend | Aufnahme für Einsätze Ø5 mm | Ableseteile mattverchromt | Box | ohne Messeinsätze | ab Messbereich 25-50 mm mit Einstellmaß (60°)
Reading 0.01 mm | spindle Ø6.5 mm, non-rotating | for inserts with shaft Ø5 mm | satin chrome finished | box | without inserts | from range 25-50 mm with setting dimension (60°)



Art.-Nr. Order no.	Messbereich Range	Genauigkeit Accuracy	EUR
11-126	0-25 mm	0,008 mm	105,00
11-127	25-50 mm		116,00
11-128	50-75 mm	0,010 mm	134,00
11-129	75-100 mm		145,00
11-129-1	100-125 mm	0,012 mm	162,00
11-129-2	125-150 mm		181,00
11-129-3	150-175 mm	0,014 mm	189,00
11-129-4	175-200 mm		204,00

Gewinde-Einsätze für Bügelmessschrauben *Thread inserts for screw micrometer*

für Gewindemessung | Aufnahme Ø5 mm | Lieferung paarweise
for screw micrometer | shaft Ø5 mm | 1 pair in each case



11-134

metrische Gewinde 60° metric threads 60°			Whitworth-Gewinde 55° Whitworth threads 55°		
Art.-Nr. Order no.	Steigung pitch	EUR	Art.-Nr. Order no.	Steigung Gang/Zoll pitch (TPI)	EUR
11-130	0,4-0,5 mm	16,90	11-140	60-48	18,50
11-131	0,6-0,9 mm	16,90	11-141	48-40	18,50
11-132	1,0-1,75 mm	16,90	11-142	40-32	18,50
11-133	2,0-3,0 mm	16,90	11-143	32-24	18,50
11-134	3,5-5,0 mm	16,90	11-144	24-18	18,50
11-135	5,5-7,0mm	16,90	11-145	18-14	18,50
11-139*	0,4-7,0 mm	98,00	11-146	14-10	18,50
			11-147	10-7	18,50
			11-148	7-4,5	18,50
			11-149	4,5-3,5	18,50

*Satz set

Einstellmaße für Gewindemessung *Setting dimensions for screw micrometer*



Art.-Nr. Order no.	Maß Dimension	EUR	Art.-Nr. Order no.	Maß Dimension	EUR	Art.-Nr. Order no.	Maß Dimension	EUR	Art.-Nr. Order no.	Maß Dimension	EUR
11-138-25	25x60°	34,50	11-138-125	125x60°	59,50	11-137-25	25x55°	36,50	11-137-125	125x55°	59,50
11-138-50	50x60°	39,50	11-138-150	150x60°	69,50	11-137-50	50x55°	39,50	11-137-150	150x55°	69,50
11-138-75	75x60°	43,50	11-138-175	175x60°	79,50	11-137-75	75x55°	43,50	11-137-175	175x55°	79,50
11-138-100	100x60°	52,50	11-138-225	225x60°	108,00	11-137-100	100x55°	52,50			

Messschrauben Micrometers

Einbaumessschrauben Micrometer heads

Ablesung 0,01 mm | Messfläche: plan | Ableseteile mattverchromt
Reading 0.01 mm | flat measuring face | satin chrome finished



Art.-Nr. Order no.	Messbereich Range	d1 mm	D mm	d2 mm	a mm	b mm	c mm	l mm	EUR
11-176	0-6,5 mm	3,5	6,0	9,4	7,5	6,0	23,5	37	22,80
11-178	0-15 mm	5,0	9,5	13,5	17,0	9,5	34,5	61	24,80
11-180	0-25 mm	6,5	10,0	18,0	27,0	15,0	66,0	108	19,50
11-181*				19,5	28,5	17,5	67,0	113	41,50
11-183**		12,0	18,0						43,50
11-185	0-50 mm	8,0	22,0	29,0	28,5	17,5	69,0	115	51,00
11-186					54,0	35,5	95,5	185	174,00

11-181* *parallaxfrei *parallax-free*

11-183** **nichtdrehende Spindel *non-rotating spindle*

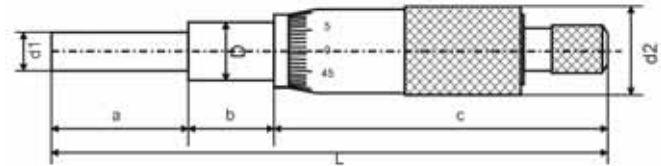

Tiefenmessschraube Depth micrometer

Ablesung 0,01 mm | Messeinsätze Ø4,5 mm | Brückenlänge 100x16 mm | Ableseteile mattverchromt | Aufbewahrungsbox
Reading 0.01 mm | measuring inserts Ø4.5 mm | base dimension 100x16 mm | satin chrome finished | box



Art.-Nr. Order no.	Messbereich Range	Messfläche Measuring face	Genauigkeit Accuracy	Anzahl Messeinsätze Number of inserts	EUR
11-171	0-100 mm	plan <i>flat</i>	0,005 mm	4	82,50
11-172	0-200 mm		0,006 mm	8	148,00
11-175	0-300 mm		0,007 mm	12	199,00
11-173	0-100 mm	ballig <i>spherical</i>	0,005 mm	4	82,50
11-174	0-200 mm		0,006 mm	8	148,00

HELIOS-PREISSER Tiefenmessschraube Depth micrometer

Ablesung 0,01 mm | Messeinsätze Ø4 mm | Klemmring | Ableseteile mattverchromt | Aufbewahrungsbox
Reading 0.01 mm | measuring inserts Ø4 mm | clamping ring | satin chrome finished | box



Art.-Nr. Order no.	Messbereich Range	Brücken- länge Length of base	Genauigkeit Accuracy	Anzahl Messeinsätze Number of inserts	EUR
46-441	0-50 mm	50 mm	0,004 mm	2	285,00
46-442	0-75 mm		0,005 mm	3	313,00
46-443	0-100 mm	100 mm	0,006 mm	4	343,00
46-444	0-150 mm			6	398,00
46-445	0-300 mm			12	645,00

Messschrauben Micrometers

Digital-Bügelmessschraube *Digital micrometer*

Auflösung 0,001 mm | Spindel Ø6,5 mm | DIN 863 | Hartmetall-Messflächen | Aufbewahrungsbox | ab Messbereich 25-50 mm mit Einstellmaß
Reading 0.001 mm | spindle Ø6.5 mm | DIN 863 | carbide measuring faces | box | from Range 25-50 mm with setting dimension



Art.-Nr. Order no.	Messbereich Range	EUR
11-206	0-25 mm	72,50
11-207	25-50 mm	82,50
11-208	50-75 mm	94,50
11-209	75-100 mm	103,00

Digital-Bügelmessschraube IP65 (wasserdicht) *Digital micrometer IP65 (waterproof)*

Auflösung 0,001 mm / 0,00005 inch | Spindel Ø6,5 mm | DIN 863 | Hartmetall-Messflächen | ABS-Funktion | wasserdicht gemäß IP65 | Aufbewahrungsbox | ab Messbereich 25-50 mm mit Einstellmaß
Reading 0.001 mm / 0.00005 inch | spindle Ø6.5 mm | DIN 863 | carbide measuring faces | ABS function | waterproof according to IP65 | box | from Range 25-50 mm with setting dimension



Art.-Nr. Order no.	Messbereich Range	EUR
11-211	0-25 mm	84,50
11-212	25-50 mm	105,00
11-213	50-75 mm	127,00
11-214	75-100 mm	145,00
11-215	100-125 mm	166,00
11-216	125-150 mm	181,00
11-217	150-175 mm	198,00
11-218	175-200 mm	219,00

Dig.-Bügelmessschraube IP65 (wasserdicht) mit Schnellverstellung *Dig. micrometer IP65 (waterproof) quick adjustment*

Auflösung 0,001 mm / 0,00005 inch | Spindel Ø6,5 mm, Spindelsteigung 2 mm/Umdrehung | DIN 863 | Hartmetall-Messflächen | ABS-Funktion | Aufbewahrungsbox | ab Messbereich 25-50 mm mit Einstellmaß
Reading 0.001 mm / 0.00005 inch | spindle Ø6.5 mm, spindle thread 2 mm/turn | DIN 863 | carbide measuring faces | ABS function | box | from Range 25-50 mm with setting dimension



Art.-Nr. Order no.	Messbereich Range	EUR
11-601	0-25 mm	165,00
11-602	25-50 mm	186,00
11-603	50-75 mm	207,00
11-604	75-100 mm	228,00

Dig.-Bügelmessschraube mit auswechselbaren Ambossen bis 600 mm *Dig. micrometer with changeable anvils up to 600 mm*

Auflösung 0,001 mm | Spindel Ø8,0 mm | Hartmetall-Messflächen | inkl. Einstellmaße | Aufbewahrungsbox
Reading 0.001 mm | spindle Ø8.0 mm | carbide measuring faces | with setting dimensions | box



Art.-Nr. Order no.	Messbereich Range	Genauigkeit Accuracy	EUR
11-231	0-150 mm	0,011 mm	264,00
11-232	150-300 mm	0,013 mm	279,00
11-233	300-400 mm	0,013 mm	305,00
11-234	400-500 mm	0,014 mm	362,00
11-235	500-600 mm	0,015 mm	410,00

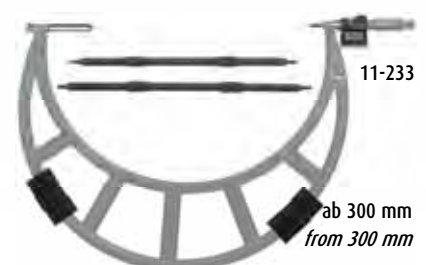

Messschrauben Micrometers

HELIOS-PREISSER Digital-Bügelmessschraube *Digital micrometer*

Auflösung 0,001 mm / 0,00005 inch | Spindel Ø6,5 mm | Genauigkeit 0,002 mm | Hartmetall-Messflächen | QuickStart-Elektronik (automatisches Einschalten / gespeicherte Nullposition) | großes Display (Ziffernhöhe 10 mm) | Hold-Funktion | Tastensperre | Aufbewahrungsbox

Reading 0.001 mm / 0.00005 inch | spindle Ø6.5 mm | Accuracy 0.002 mm | carbide measuring faces | Quick-Start-electronic (automatic switch on / saved position of zero) | large display (height of digits 10 mm) | Hold function | key lock | box



Art.-Nr. Order no.	Messbereich Range	EUR
46-380	0-25 mm	169,00

HELIOS-PREISSER Digital-Bügelmessschraube IP65 (wasserdicht) *Digital micrometer IP65 (waterproof)*

Auflösung 0,001 mm / 0,00005 inch | Spindel Ø6,5 mm | Hartmetall-Messflächen | QuickStart-Elektronik (automatisches Einschalten / gespeicherte Nullposition) | großes Display (Ziffernhöhe 10 mm) | Hold-Funktion | Tastensperre | wasserdicht gemäß IP65 | ab Messbereich 25-50 mm mit Einstellmaß | Aufbewahrungsbox

Reading 0.001 mm / 0.00005 inch | spindle Ø6.5 mm | carbide measuring faces | Quick-Start-electronic (automatic switch on / saved position of zero) | large display (height of digits 10 mm) | Hold function | key lock | waterproof according to IP65 | from Range 25-50 mm with setting dimension | box



Art.-Nr. Order no.	Messbereich Range	Genauigkeit Accuracy	EUR
46-381	0-25 mm	0,002 mm	199,00
46-382	25-50 mm		265,00
46-383	50-75 mm	0,003 mm	334,00
46-384	75-100 mm		383,00

HELIOS-PREISSER Digital-Bügelmessschraube mit Schnellverstellung und Datenausgang *Digital micrometer with quick adjustment and data output*

Auflösung 0,001 mm / 0,00005 inch | Spindel Ø6,5 mm, nichtdrehend | Schnellverstellung 5 mm/Umdrehung | wasserdicht gemäß IP65 | Hartmetall-Messflächen | QuickStart-Elektronik (automatisches Einschalten / gespeicherte Nullposition) | variabler Datenausgang USB / Digimatic | großes Display (Ziffernhöhe 10 mm) | Hold-Funktion | Toleranzwerteingabe | Maßvoreinstellung (ORIGIN) | Tastensperre | ab Messbereich 25-50 mm mit Einstellmaß | Aufbewahrungsbox

Reading 0.001 mm / 0.00005 inch | spindle Ø6.5 mm, non-rotating | quick adjustment 5 mm/turn | waterproof according to IP65 | carbide measuring faces | Quick-Start-electronic (automatic switch on / saved position of zero) | variable data output USB / Digimatic | large display (height of digits 10 mm) | Hold function | tolerance setting | preset function (ORIGIN) | key lock | from Range 25-50 mm with setting dimension | box



Art.-Nr. Order no.	Messbereich Range	Genauigkeit Accuracy	EUR
46-386	0-25 mm	0,002 mm	333,00
46-387	25-50 mm		379,00
46-388	50-75 mm	0,003 mm	479,00
46-389	75-100 mm		519,00

Informationen und Zubehör zum Thema Datenübertragung finden Sie in Kapitel 15!
Information and accessories related to data transfer can be found in chapter 15!

Messschrauben Micrometers

HELIOS-PREISSER Digital-Bügelmessschraube mit Funk-Datenübertragung *Digital micrometer with wireless data output*

Auflösung 0,001 mm / 0,00005 inch | Spindel Ø6,5 mm | wasserdicht gemäß IP65 | Hartmetall-Messflächen | integrierter Funksender „Integrated Wireless“ | QuickStart-Elektronik (automatisches Einschalten / gespeicherte Nullposition) | großes Display (Ziffernhöhe 10 mm) | Hold-Funktion | Toleranzwerteingabe | Maßvoreinstellung (ORIGIN) | Tastensperre | ab Messbereich 25-50 mm mit Einstellmaß | Aufbewahrungsbox

Reading 0.001 mm / 0.00005 inch | spindle Ø6.5 mm | waterproof according to IP65 | carbide measuring faces | data output with "integrated Wireless" | Quick-Start-electronic (automatic switch on / saved position of zero) | large display (height of digits 10 mm) | Hold function | tolerance setting | preset function (ORIGIN) | key lock | from Range 25-50 mm with setting dimension | box



Art.-Nr. Order no.	Messbereich Range	Genauigkeit Accuracy	EUR
46-391	0-25 mm	0,002 mm	254,00
46-392	25-50 mm		313,00
46-393	50-75 mm	0,003 mm	382,00
46-394	75-100 mm		427,00

HELIOS-PREISSER Digital-Bügelmessschrauben im Satz *Digital micrometers in set*

4 Bügelmessschrauben im Satz | Messbereich 0-100 mm | technische Daten: siehe Einzel-Bügelmessschrauben | inkl. Einstellmaße 25/50/75 mm | Aufbewahrungskoffer

4 micrometers in set | Range 0-100 mm | technical data: look at single micrometers | incl. setting dimensions 25/50/75 mm | box



Art.-Nr. Order no.	Datenausgang Data output	EUR
46-398	Funk („Integrated Wireless“) Wireless („Integrated Wireless“)	1358,00
46-399	variabler Datenausgang USB / Digimatic variable data output USB / Digimatic	1329,00

HELIOS-PREISSER USB-Empfänger für Funk-Datenübertragung *USB receiver for wireless data transfer*

für bis zu 8 HELIOS-PREISSER Messgeräte mit „Integrated Wireless“ | Funkdistanz bis zu 6 m | USB-Anschluss | Software „MarCom Professional“ für Windows 7/8/10 zum Übertragen der Messwerte in Anwendungen kostenlos downloadbar auf www.helios-preisser.de

For up to 8 HELIOS-PREISSER measuring tools with "Integrated Wireless" | radio distance up to 6 m | USB interface | Software "MarCom Professional" for Windows 7/8/10 for transferring measuring values into applications free download at www.helios-preisser.de



Art.-Nr. Order no.	EUR
46-099	93,50

Messschrauben Micrometers

SYLVAC Digital-Bügelmessschraube IP67 (wasserdicht) mit Schnellverstellung und Datenausgang Digital micrometer IP67 (waterproof) with quick adjustment and data output

Auflösung 0,001 mm | Spindel Ø6,5 mm, nichtdrehend | Schnellverstellung 10 mm/Umdrehung | Hartmetall-Messflächen | Datenausgang „Proximity“ (USB/RS232) | automatisches Ein- und Ausschalten | wasserdicht gemäß IP67 | Aufbewahrungsbox

Reading 0.001 mm | spindle Ø6.5 mm, non-rotating | quick adjustment 10 mm/turn | carbide measuring faces | data output "Proximity" (USB/RS232) | automatic switch-on and switch-off | waterproof according to IP67 | box



Art.-Nr. Order no.	Messbereich Range	Genauigkeit Accuracy	EUR
19-101	0-30 mm	0,003 mm	324,00
19-102	30-66 mm	0,004 mm	461,00
19-103	66-102 mm	0,005 mm	576,00
19-104	100-136 mm	0,007 mm	1358,00
19-105	125-161 mm	0,008 mm	1469,00
19-109*	0-102 mm		1359,00

*3tlg. Satz im Koffer Set of 3 pieces in box

Varianten mit speziellen Messflächen:

Variants with special measuring faces:

- zylindrisch
cylindrical

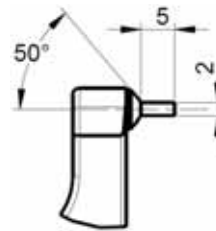

Art.-Nr. Order no.	Messbereich Range	EUR
19-111	0-25 mm	459,00
19-112	25-60 mm	633,00
19-113	60-95 mm	754,00

- schneidenförmig (Schneidendicke 0,75 mm)
blade-shaped (blade thickness 0.75 mm)

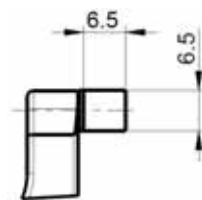

Art.-Nr. Order no.	Messbereich Range	EUR
19-121	0-25 mm	656,00
19-122	25-60 mm	829,00
19-123	60-95 mm	962,00

- tellerförmig
disc-shaped



Art.-Nr. Order no.	Messbereich Range	EUR
19-131	0-30 mm	792,00

- sphärisch
spherical

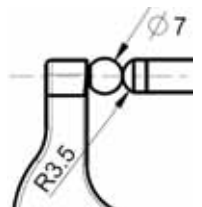

Art.-Nr. Order no.	Messbereich Range	EUR
19-141	0-25 mm	618,00

Informationen und Zubehör zum Thema Datenübertragung finden Sie in Kapitel 15!
Information and accessories related to data transfer can be found in chapter 15!

Messschrauben

Micrometers

Digital-Bügelmessschraube für Nuten *Digital blade micrometer for grooves*

Auflösung 0,001 mm | Spindel Ø6,5 mm, nichtdrehend | Messfläche 0,75x6 mm | wasserdicht gemäß IP65 | Genauigkeit 0,005 mm | Aufbewahrungsbox | für Messbereich 25-50 mm mit Einstellmaß

Reading 0.001 mm | spindle Ø6.5 mm, non-rotating | measuring face 0.75x6 mm | waterproof according to IP65 | accuracy 0.005 mm | box | range 25-50 mm with setting dimension



Art.-Nr. Order no.	Messbereich Range	EUR
11-261	0-25 mm	199,00
11-262	25-50 mm	218,00

Digital-Bügelmessschraube mit kleiner Messfläche *Digital micrometer with small measuring face*

Auflösung 0,001 mm | Spindel Ø6,5 mm | Messfläche Ø2,0 mm | wasserdicht gemäß IP65 | Genauigkeit 0,005 mm | Aufbewahrungsbox | für Messbereich 25-50 mm mit Einstellmaß

Reading 0.001 mm | spindle Ø6.5 mm | measuring face Ø2.0 mm | waterproof according to IP65 | accuracy 0.005 mm | box | range 25-50 mm with setting dimension



Art.-Nr. Order no.	Messbereich Range	EUR
11-266	0-25 mm	182,00
11-267	25-50 mm	198,00

Digital-Bügelmessschraube für Rohrwanddickenmessung *Digital tube micrometer*

Auflösung 0,001 mm | Spindel Ø6,5 mm | Messflächen ballig/plan | Rohrrinnendurchmesser min. Ø10 mm | wasserdicht gemäß IP65 | Genauigkeit 0,004 mm | Aufbewahrungsbox

Reading 0.001 mm | spindle Ø6.5 mm | measuring face spherical/flat | tube inside diameter min. Ø10 mm | waterproof according to IP65 | accuracy 0.004 mm | box



Art.-Nr. Order no.	Messbereich Range	EUR
11-611	0-25 mm	192,00

Digital-Bügelmessschraube mit Tellermessflächen *Digital disc micrometer*

Auflösung 0,001 mm | nichtdrehende Spindel | Teller Ø20 mm | Genauigkeit 0,004 mm | Aufbewahrungsbox | für Messbereich 25-50 mm mit Einstellmaß

Reading 0.001 mm | non-rotating spindle | disc Ø20 mm | accuracy 0.004 mm | box | range 25-50 mm with setting dimension



Art.-Nr. Order no.	Messbereich Range	EUR
11-621	0-25 mm	238,00
11-622	25-50 mm	259,00

01

02

03

04

05

06

07

08

09

10

11

12

13

14

15

Messschrauben Micrometers

Digital-Bügelmessschraube mit Hartmetall-Spitzen *Digital micrometer with carbide points*

Auflösung 0,001 mm | Hartmetall-Spitzen Ø6,5 mm x 30° / SR 0,3 mm | IP65 | Genauigkeit 0,005 mm | Spindelsteigung 2mm | Aufbewahrungsbox
Reading 0.001 mm | carbide measuring points Ø6.5 mm x 30° / SR 0.3 mm | IP65 | accuracy 0.005 mm | spindle pitch 2 mm | box



Art.-Nr. Order no.	Messbereich Range	EUR
11-628	0-25 mm	327,00

Digital-Bügelmessschraube mit großem Amboss *Digital micrometer with large anvil*

Auflösung 0,001 mm | Spindel Ø6,5 mm | Genauigkeit 0,005 mm | Aufbewahrungsbox | für Messbereich 25-50 mm mit Einstellmaß
Reading 0.001 mm | spindle Ø6.5 mm | accuracy 0.005 mm | box | range 25-50 mm with setting dimension



Art.-Nr. Order no.	Messbereich Range	Amboss Anvil	EUR
11-631	0-25 mm	50x14 mm	248,00
11-632	25-50 mm	60x14 mm	277,00

Einstellmaß für Bügelmessschrauben *Setting dimension for micrometers*

zum Einstellen von Außenmessschrauben | flache Messflächen | mit Wärmeschutz
for calibration of outside micrometers | flat measuring faces | with heat insulation



11-447-025

Art.-Nr. Order no.	Nennmaß Dimension	Durchmesser Diameter	Genauigkeit Accuracy	EUR
11-447-025	25 mm	Ø7 mm	0,002 mm	4,50
11-447-050	50 mm			4,90
11-447-075	75 mm			5,40
11-447-100	100 mm	Ø8 mm	0,0025 mm	6,00
11-447-125	125 mm			7,60
11-447-150	150 mm		0,003 mm	8,80
11-447-175	175 mm			10,70
11-447-200	200 mm		0,0035 mm	14,50
11-447-225	225 mm			19,80
11-447-250	250 mm	19,80		
11-447-275	275 mm		19,80	

Weitere Abmessungen auf Anfrage!
Further dimensions on request!

Einstellmaße für Gewindemessung *Setting dimensions for screw micrometer*

zum Einstellen von Bügelmessschrauben für Gewindemessung | mit Wärmeschutz
for calibration of screw micrometers | with heat insulation



11-138-50

Art.-Nr. Order no.	Maß Dimension	EUR	Art.-Nr. Order no.	Maß Dimension	EUR	Art.-Nr. Order no.	Maß Dimension	EUR	Art.-Nr. Order no.	Maß Dimension	EUR
11-138-25	25x60°	34,50	11-138-125	125x60°	59,50	11-137-25	25x55°	36,50	11-137-125	125x55°	59,50
11-138-50	50x60°	39,50	11-138-150	150x60°	69,50	11-137-50	50x55°	39,50	11-137-150	150x55°	69,50
11-138-75	75x60°	43,50	11-138-175	175x60°	79,50	11-137-75	75x55°	43,50	11-137-175	175x55°	79,50
11-138-100	100x60°	52,50	11-138-225	225x60°	108,00	11-137-100	100x55°	52,50			

Messschrauben Micrometers

Digital-Bügelmessschraube mit **auswechselbaren Einsätzen** *Digital micrometer with changeable inserts*

Auflösung 0,001 mm | Spindel Ø8 mm, nichtdrehend | Aufnahme für Einsätze Ø5 mm | wasserdicht gemäß IP65 | Aufbewahrungsbox | inklusive 7 Paar Messeinsätze | ab Messbereich 25-50 mm mit Einstellmaß

Reading 0.001 mm | spindle Ø6.5 mm, non-rotating | for inserts with shaft Ø5 mm | waterproof according to IP65 | box | incl. 7 pairs of inserts | from range 25-50 mm with setting dimension

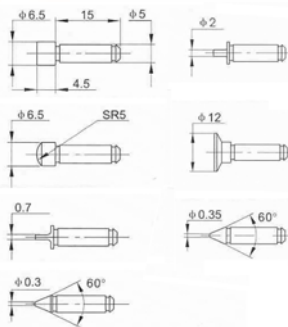

enthaltene Messeinsätze (jeweils 1 Paar)
included inserts (1 pair in each case)



Art.-Nr. Order no.	Messbereich Range	Genauigkeit Accuracy	EUR
11-251	0-25 mm	0,008 mm	289,00
11-252	25-50 mm		315,00
11-253	50-75 mm	0,010 mm	326,00
11-254	75-100 mm		342,00
11-255	100-125 mm	0,012 mm	359,00
11-256	125-150 mm		374,00
11-257	150-175 mm	0,014 mm	385,00
11-258	175-200 mm		398,00

Ersatz-Messeinsätze: siehe Seite 01.24
Inserts as spare parts: see page 01.24

Digital-Bügelmessschraube für **Gewindemessung** *Digital screw micrometer*

Auflösung 0,001 mm | Spindel Ø8 mm, nichtdrehend | Aufnahme für Einsätze Ø5 mm | wasserdicht gemäß IP65 | Aufbewahrungsbox | ohne Messeinsätze | ab Messbereich 25-50 mm mit Einstellmaß (60°)

Reading 0.001 mm | spindle Ø6.5 mm, non-rotating | for inserts with shaft Ø5 mm | waterproof according to IP65 | box | without inserts | from range 25-50 mm with setting dimension (60°)



Art.-Nr. Order no.	Messbereich Range	Genauigkeit Accuracy	EUR
11-241	0-25 mm	0,008 mm	214,00
11-242	25-50 mm		223,00
11-243	50-75 mm	0,010 mm	259,00
11-244	75-100 mm		286,00
11-245	100-125 mm	0,012 mm	312,00
11-246	125-150 mm		342,00
11-247	150-175 mm	0,014 mm	356,00
11-248	175-200 mm		389,00

Gewinde-Einsätze für Bügelmessschrauben *Thread inserts for screw micrometer*

für Gewindemessung | Aufnahme Ø5 mm | Lieferung paarweise
for screw micrometer | shaft Ø5 mm | 1 pair in each case



11-134

metrische Gewinde 60° metric threads 60°			Whitworth-Gewinde 55° Whitworth threads 55°		
Art.-Nr. Order no.	Steigung pitch	EUR	Art.-Nr. Order no.	Steigung Gang/Zoll pitch (TPI)	EUR
11-130	0,4-0,5 mm	16,90	11-140	60-48	18,50
11-131	0,6-0,9 mm	16,90	11-141	48-40	18,50
11-132	1,0-1,75 mm	16,90	11-142	40-32	18,50
11-133	2,0-3,0 mm	16,90	11-143	32-24	18,50
11-134	3,5-5,0 mm	16,90	11-144	24-18	18,50
11-135	5,5-7,0 mm	16,90	11-145	18-14	18,50
11-139	0,4-7,0 mm	98,00	11-146	14-10	18,50
			11-147	10-7	18,50
			11-148	7-4,5	18,50
			11-149	4,5-3,5	18,50

Messschrauben Micrometers

Digital-Einbaumessschraube *Digital micrometer head*

Auflösung 0,001 mm | Aufnahme Ø12 h7 | Messfläche: plan | IP65
Reading 0.001 mm | shank Ø12 h7 | measuring face: flat | IP65



Art.-Nr. Order no.	Messbereich Range	Genauigkeit Accuracy	EUR
11-281	0-25 mm	0,004 mm	132,00
11-282	0-50 mm	0,006 mm	218,00
11-281H*	0-25 mm	0,004 mm	159,00
11-282H*	0-50 mm	0,006 mm	246,00

*mit Handrad *with hand wheel*

SYLVAC Digital-Einbaumessschraube mit Datenausgang *Digital micrometer head with data output*

Auflösung 0,001 mm | Spindel Ø6,5 mm, nichtdrehend | Aufnahme Ø12 h6 | Hartmetall-Messflächen | Handrad Ø50 mm | Anzeige um 270° drehbar | Datenausgang „Power“ (USB/RS232) | automatisches Ein- und Ausschalten | Swiss made | inkl. Herstellerzertifikat
Reading 0.001 mm | spindle Ø6.5 mm, non-rotating | shank Ø12 h6 | carbide measuring faces | hand wheel Ø50 mm | display rotatable 270° | data output "Power" (USB/RS232) | automatic switch-on and switch-off | Swiss made | manufacturers certificate included



Art.-Nr. Order no.	Messbereich Range	Genauigkeit Accuracy	EUR
19-181	0-25 mm	0,005 mm	589,00
19-182	0-50 mm	0,008 mm	798,00

Informationen und Zubehör zum Thema Datenübertragung finden Sie in Kapitel 15!
Information and accessories related to data transfer can be found in chapter 15!

SYLVAC Digital-Einbaumessschraube Bluetooth® Datenausgang *Digital micrometer head Bluetooth® data output*

Auflösung 0,001 mm | Spindel Ø6,5 mm, nichtdrehend | Aufnahme Ø12 h6 | Hartmetall-Messflächen | Handrad Ø50 mm | Anzeige um 270° drehbar | Datenausgang Bluetooth (kabellos) | automatisches Ein- und Ausschalten | Umkehrung der Messrichtung | Preset-Funktion | Swiss made | inkl. Herstellerzertifikat
Reading 0.001 mm | spindle Ø6.5 mm, non-rotating | shank Ø12 h6 | carbide measuring faces | hand wheel Ø50 mm | display rotatable 270° | data output Bluetooth (wireless) | automatic switch-on and switch-off | reversion of measuring direction | Preset function | Swiss made | manufacturers certificate included



Art.-Nr. Order no.	Messbereich Range	Genauigkeit Accuracy	EUR
19-183	0-25 mm	0,005 mm	675,00
19-184	0-50 mm	0,008 mm	895,00

SYLVAC USB-Dongle Bluetooth® *USB dongle Bluetooth®*



USB-Empfängereinheit für Windows 10 | für bis zu 8 SYLVAC-Messgeräte mit Bluetooth-Datenausgang | automatische Erkennung der Messgeräte | inkl. Software „Vmux“



USB receiver for Windows | for up to 8 SYLVAC measuring tools with Bluetooth data output | automatic detection of measuring tools | incl. Software "Vmux"

Art.-Nr. Order no.	EUR
19-399	79,50

Messschrauben

Micrometers

Digital-Tiefen-Messschraube *Digital depth micrometer*

Auflösung 0,001 mm | Messeinsatz Ø4,5 mm | Messfläche: plan | Brückenlänge 100x16 mm | IP65 | Aufbewahrungsbox
 Reading 0.001 mm | measuring inserts Ø4.5 mm | measuring face: flat | base dimension 100x16 mm | IP65 | box



Art.-Nr. Order no.	Messbereich Range	Genauigkeit Accuracy	Anz. Messeinsätze Number of inserts	EUR
11-291	0-100 mm	0,005 mm	4	198,00
11-292	0-200 mm	0,006 mm	8	244,00



Messuhren

Dial gauges



Inhalt Contents



03.2



03.8



03.11



03.17



03.18



03.21



03.24



03.32

Normen Standards

Alle unsere Messuhren nach DIN 878 erfüllen folgende Werte:

All our dial gauges according to DIN 878 comply with following values:

Messbereich (mm) Range (mm)	0,4	0,8	3	5	10
Genauigkeit* (mm) Accuracy (mm)	±0,007	±0,007	±0,010	±0,012	±0,015

*Grenzwert für Messabweichung der Anzeige über den gesamten Messbereich

Alle unsere Fühlhebelmessgeräte nach DIN 2270 erfüllen folgende Werte:

All our dial test indicators acc. to DIN 2270 comply with following values:

Ablesung (mm) Range (mm)	0,01	0,002
Genauigkeit* (mm) Accuracy (mm)	0,013	0,004

*Abweichungsspanne f_{ges}

Weitere Informationen: siehe DIN 878/2270 (DIN Deutsches Institut für Normung e. V., erschienen im Beuth Verlag)

Further information: see DIN 878/2270 (DIN Deutsches Institut für Normung e. V., published by Beuth Verlag)

Kalibrierung Calibration

Informationen zur Kalibrierung erhalten Sie in Kapitel 15!

Information about calibration can be found in chapter 15!

Messuhren Dial gauges

Messuhr Dial gauge



12-002

Ablesung 0,01 mm | Skala 0-100 | verstellbare Toleranzmarken | Gehäuse Ø58 mm | Schaft Ø8 h6
Reading 0.01 mm | scale 0-100 | adjustable tolerance marks | housing Ø58 mm | shank Ø8 h6

Art.-Nr. Order no.	Messbereich Range	Genauigkeit Accuracy	Hysterese Hysteresis	EUR
12-001	10 mm	0,02 mm	3 µm	18,90
12-002	30 mm	0,035 mm	7 µm	44,50
12-003	50 mm	0,04 mm	8 µm	81,00
12-004	100 mm	0,05 mm	9 µm	241,00

Messuhr mit Stoßschutz Dial gauge shock proof



Ablesung 0,01 mm | Edelstein gelagert | Skala 0-100 | verstellbare Toleranzmarken | Gehäuse Ø58 mm | Schaft Ø8 h6
Reading 0.01 mm | bearing jewels | scale 0-100 | adjustable tolerance marks | housing Ø58 mm | shank Ø8 h6

Art.-Nr. Order no.	Messbereich Range	Genauigkeit Accuracy	Hysterese Hysteresis	EUR
12-011	10 mm	0,02 mm	3 µm	29,80

Messuhr 0,001 mm Dial gauge 0.001 mm



Ablesung 0,001 mm | Edelstein gelagert | Skala 0-100-0 | verstellbare Toleranzmarken | Gehäuse Ø58 mm | Schaft Ø8 h6
Reading 0.001 mm | bearing jewels | scale 0-100-0 | adjustable tolerance marks | housing Ø58 mm | shank Ø8 h6

Art.-Nr. Order no.	Messbereich Range	Genauigkeit Accuracy	Hysterese Hysteresis	EUR
12-016	1 mm	0,005 mm	2 µm	57,00

Messuhren Dial gauges

Messuhr mit kleinem Gehäuse Dial gauge with small housing

Ablesung 0,01 mm | Edelstein gelagert | Skala 0-100 | verstellbare Toleranzmarken | Gehäuse Ø40 mm | Schaft Ø8 h6
 Reading 0.01 mm | bearing jewels | scale 0-100 | adjustable tolerance marks | housing Ø40 mm | shank Ø8 h6



12-022

Art.-Nr. Order no.	Messbereich Range	Genauigkeit Accuracy	Hysteresis Hysteresis	EUR
12-021	3 mm	0,014 mm	3 µm	27,50
12-022	5 mm	0,016 mm	3 µm	31,00

Komparator Dial comparator

Ablesung 0,001 mm | Gehäuse Ø62 mm | Schaft Ø8 h6 | Genauigkeit 0,002 mm | verstellbare Toleranzmarken | Aufbewahrungsbox
 Reading 0.001 mm | housing Ø62 mm | shank Ø8 h6 | accuracy 0.002 mm | adjustable tolerance marks | box



Art.-Nr. Order no.	Messbereich Range	EUR
12-061	±0,05 mm	174,00

KÄFER Messuhr 0,1 mm Dial gauge 0.1 mm

Ablesung 0,1 mm | Skala 0-10 | Gehäuse Ø58 mm | Schaft Ø8 h6 | Made in Germany | Aufbewahrungsbox
 Reading 0.1 mm | scale 0-10 | housing Ø58 mm | shank Ø8 h6 | Made in Germany | box



19-501

19-503

Art.-Nr. Order no.	Messbereich Range	Genauigkeit Accuracy	EUR
19-501	10 mm	0,05 mm	44,00
19-502	20 mm		52,00
19-503	30 mm	0,08 mm	53,50
19-504	50 mm		138,00

Messuhren Dial gauges

KÄFER Messuhr 0,01 mm Dial gauge 0.01 mm

Ablesung 0,01 mm | Skala 0-100 | Gehäuse Ø58 mm | Schaft Ø8 h6 | Genauigkeit nach DIN 878 | verstellbare Toleranzmarken | Aufbewahrungsbox
 Reading 0.01 mm | scale 0-100 | housing Ø58 mm | shank Ø8 h6 | accuracy according to DIN 878 | adjustable tolerance marks | box

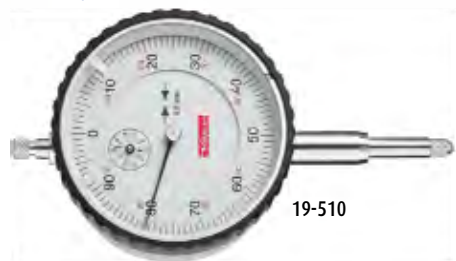

19-510

Art.-Nr. Order no.	Messbereich Range	Stoßschutz Shock proof	EUR
19-510	10 mm	nein no	28,00
19-511		ja yes	33,50

KÄFER Präzisionsmessuhr 0,01 mm „TOP“ Precision dial gauge 0.01 mm „TOP“

Ablesung 0,01 mm | Skala 0-100 | Gehäuse Ø58 mm | Schaft Ø8 h6 | Genauigkeit nach DIN 878 | verstellbare Toleranzmarken | Made in Germany | Aufbewahrungsbox
 Reading 0.01 mm | scale 0-100 | housing Ø58 mm | shank Ø8 h6 | accuracy according to DIN 878 | adjustable tolerance marks | Made in Germany | box



19-513

Art.-Nr. Order no.	Messbereich Range	Stoßschutz Shock proof	EUR
19-513	10 mm	nein no	34,50
19-514		ja yes	41,00

KÄFER Präzisionsmessuhr 0,001 mm Precision dial gauge 0.001 mm

Ablesung 0,001 mm | Genauigkeit 0,012 mm | Wiederholbarkeit 0,5 µm | Skala 2x 0-100 | Gehäuse Ø58 mm | Schaft Ø8 h6 | mit Stoßschutz | verstellbare Toleranzmarken | Made in Germany | Aufbewahrungsbox
 Reading 0.001 mm | Accuracy 0.012 mm | Repeatability 0.5 µm | scale 2x 0-100 | housing Ø58 mm | shank Ø8 h6 | shock proof | adjustable tolerance marks | Made in Germany | box



Art.-Nr. Order no.	Messbereich Range	EUR
19-540	5 mm	134,00

KÄFER Präzisionsmessuhr mit großem Messbereich Precision dial gauge with large measuring range

Ablesung 0,01 mm | Skala 0-100 | Gehäuse Ø58 mm | verstellbare Toleranzmarken | Made in Germany | bei Messbereich 100 mm: Einsatz nur in senkrechter Lage
 Reading 0.01 mm | scale 0-100 | housing Ø58 mm | shank Ø8 h6 | adjustable tolerance marks | Made in Germany | Range 100 mm: vertical operation only



19-528

Art.-Nr. Order no.	Messbereich Range	Schaft shank	EUR
19-525	50 mm	Ø8 h6	132,00
19-528	80 mm		271,00
19-530	100 mm	Ø10 h6	345,00

Messuhren Dial gauges

KÄFER Kleinmessuhr Small dial gauge

Ablesung 0,01 mm | Skala 0-50 | Gehäuse Ø28 mm | Schaft Ø8 h6 | Made in Germany | Aufbewahrungsbox
Reading 0.01 mm | scale 0-50 | housing Ø28 mm | shank Ø8 h6 | Made in Germany | box



Art.-Nr. Order no.	Messbereich Range	EUR
19-551	3,5 mm	77,00

KÄFER Großmessuhr Large dial gauge

Ablesung 0,01 mm | Skala 0-100 | Gehäuse Ø80 mm | Schaft Ø8 h6 | Made in Germany | Aufbewahrungsbox
Reading 0.01 mm | scale 0-100 | housing Ø80 mm | shank Ø8 h6 | Made in Germany | box

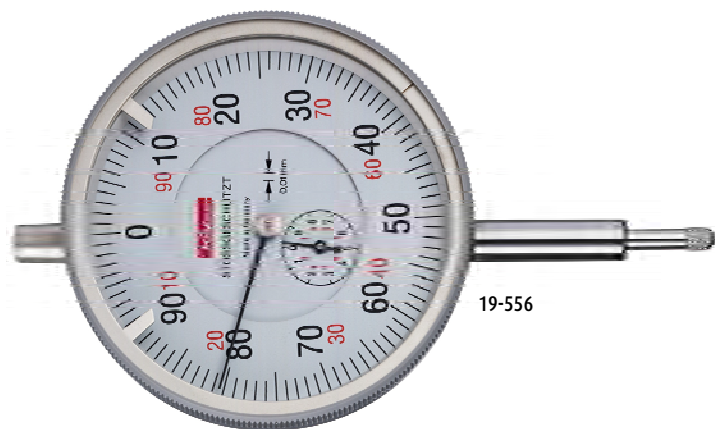

Art.-Nr. Order no.	Messbereich Range	Stoßschutz Shock proof	EUR
19-555	10 mm	nein no	102,00
19-556		ja yes	116,00

KÄFER Präzisionsmessuhr IP67 (wasser-/staubdicht) Precision dial gauge IP67 (waterproof/dustproof)

mit Stoßschutz | Gehäuse Ø61,5 mm | Schaft Ø8 h6 | verstellbare Toleranzmarken | Made in Germany
shock proof | housing Ø61.5 mm | shank Ø8 h6 | adjustable tolerance marks | Made in Germany



Art.-Nr. Order no.	Messbereich Range	Ablesung Reading	Skala Scale	EUR
19-560	10 mm	0,01 mm	0-100	103,00
19-570	1 mm	0,001 mm	2x 0-100	163,00

! Achtung! Diese Messuhren sind nicht geeignet zum Einbau in Tiefenmessbrücken, Messpistolen o. ä.!
Caution! These dial gauges don't fit into depth measuring bases, measuring pistols etc.!

KÄFER Messuhr mit rückwärtigem Messbolzen Dial gauge with backside measuring tip

Ablesung 0,01 mm | Schaft Ø8 h6 / Ø28 h6 | verstellbare Toleranzmarken | Made in Germany
Reading 0.01 mm | shank Ø8 h6 / Ø28 h6 | adjustable tolerance marks | Made in Germany



Art.-Nr. Order no.	Gehäuse Housing	Messbereich Range	Genauigkeit Accuracy	Skala Scale	EUR
19-821	Ø40 mm	3 mm	0,015 mm	0-50	98,00
19-822		5 mm	0,020 mm		103,00
19-825	Ø58 mm	3 mm	0,015 mm	0-100	98,00
19-826		5 mm	0,020 mm		103,00

Messuhren Dial gauges

KÄFER Messuhr mit Kunststoffgehäuse Dial gauge with plastics housing

leichte Messuhr durch Verwendung eines Gehäuses aus hochwertigem Polyamid | Ablesung 0,01 mm | Skala 0-100 | Gehäuse Ø58 mm | Schaft Ø8 h6 | Genauigkeit nach DIN 878 | verstellbare Toleranzmarken | Made in Germany | Aufbewahrungsbox
Lightweight dial gauge through use of housing made of high-quality polyamide | Reading 0.01 mm | scale 0-100 | housing Ø58 mm | shank Ø8 h6 | accuracy according to DIN 878 | adjustable tolerance marks | Made in Germany | box



Art.-Nr. Order no.	Messbereich Range	EUR
19-516	10 mm	32,80

KÄFER Messuhr linkslaufend Dial gauge left-turning

linkslaufend beziffert (Messuhr zeigt im Ruhezustand Maximalwert an und zählt herunter) | Ablesung 0,01 mm | Skala 0-100 | Gehäuse Ø58 mm | Schaft Ø8 h6 | Genauigkeit nach DIN 878 | verstellbare Toleranzmarken | Made in Germany | Aufbewahrungsbox

Left-turning numbering (Dial gauges shows maximum in non-operating state and decrements) | Reading 0.01 mm | scale 0-100 | housing Ø58 mm | shank Ø8 h6 | accuracy according to DIN 878 | adjustable tolerance marks | Made in Germany | box



Art.-Nr. Order no.	Messbereich Range	EUR
19-517	10 mm	48,50

KÄFER Messuhr mit umgekehrtem Federzug Dial gauge with reverse spring direction

umgekehrte Federkraft | Ablesung 0,01 mm | Skala 0-100 | Gehäuse Ø58 mm | Schaft Ø8 h6 | Genauigkeit nach DIN 878 | verstellbare Toleranzmarken | Made in Germany | Aufbewahrungsbox

Reverse spring direction | Reading 0.01 mm | scale 0-100 | housing Ø58 mm | shank Ø8 h6 | accuracy according to DIN 878 | adjustable tolerance marks | Made in Germany | box



Art.-Nr. Order no.	Messbereich Range	EUR
19-518	10 mm	54,50

KÄFER Messuhr mit doppeltem Einspannschaft Dial gauge with double clamping shank

doppelter Einspannschaft (oben und unten) | Ablesung 0,01 mm | Skala 0-100 | Gehäuse Ø58 mm | Schaft Ø8 h6 | Genauigkeit nach DIN 878 | verstellbare Toleranzmarken | Made in Germany | Aufbewahrungsbox

Double clamping shank (top and bottom) | Reading 0.01 mm | scale 0-100 | housing Ø58 mm | shank Ø8 h6 | accuracy according to DIN 878 | adjustable tolerance marks | Made in Germany | box



Art.-Nr. Order no.	Messbereich Range	EUR
19-519	10 mm	84,00

Messuhren Dial gauges

KÄFER Komparator Dial comparator

mit Stoßschutz | Gehäuse Ø58 mm | Schaft Ø8 h6 | verstellbare Toleranzmarken | Made in Germany | Aufbewahrungsbox
shock proof | housing Ø58 mm | shank Ø8 h6 | adjustable tolerance marks | Made in Germany | box

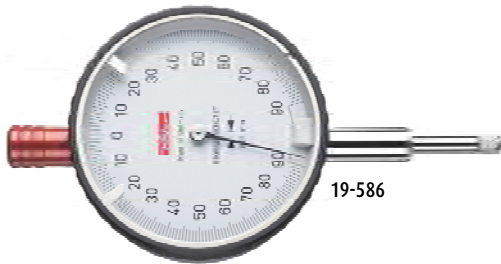

19-586

Art.-Nr. Order no.	Messbereich Range	Ableseung Reading	Freihub free lift	EUR
19-586	±0,8 mm	0,01 mm	8 mm	64,50
19-590	±0,08 mm	0,001 mm	4,5 mm	123,00

KÄFER Feinzeiger „Compika“ Dial comparator „Compika“

mit Stoßschutz und Freihub | Genauigkeit nach DIN 879 | Gehäuse Ø62 mm | Schaft Ø8 h6 | verstellbare Toleranzmarken | Made in Germany | Aufbewahrungsbox



19-811

shock proof and free lift | accuracy according to DIN 879 | housing Ø62 mm | shank Ø8 h6 | adjustable tolerance marks | Made in Germany | box

Art.-Nr. Order no.	Messbereich Range	Ableseung Reading	Messbolzen-Überstand L* Measuring tip overhang L*	EUR
19-801	±0,25 mm	0,01 mm	14 mm	144,00
19-802			6 mm	144,00
19-811	±0,05 mm	0,001 mm	14 mm	179,00
19-812			6 mm	179,00



*Messbolzen-Überstand L:
 14 mm (Standard)
 6 mm (verkürzt, zum Einbau in gängige Innenmessgeräte/Messvorrichtungen)
*Measuring tip overhang L:
 14 mm (standard)
 6 mm (shortened, for popular inside measuring devices/measuring fixtures)*

KÄFER Feinzeiger „Compika“ wassergeschützt IP53 Dial comparator „Compika“ water resistant IP53

mit Stoßschutz und Freihub | Genauigkeit nach DIN 879 | Gehäuse Ø62 mm | Schaft Ø8 h6 | verstellbare Toleranzmarken | wassergeschützt gemäß IP53 | Made in Germany | Aufbewahrungsbox



shock proof and free lift | accuracy according to DIN 879 | housing Ø62 mm | shank Ø8 h6 | adjustable tolerance marks | water resistant according to IP53 | Made in Germany | box

Art.-Nr. Order no.	Messbereich Range	Ableseung Reading	EUR
19-813	±0,05 mm	0,001 mm	204,00



Achtung! Dieser Artikel ist nicht geeignet zum Einbau in Tiefenmessbrücken, Messpistolen o. ä!
Caution! This product doesn't fit into depth measuring bases, measuring pistols etc.!

Einsätze für Messuhr *Measuring tips for dial gauges*

Aufnahmegewinde M2,5 | Spezialstahl, gehärtet | passend für alle gängigen Messuhren und die Messschieber 10-34.../10-71.../46-081/46-293/46-294
Fixing thread M2.5 | special steel, hardened | suitable for all current dial gauges and calipers 10-34.../10-71.../46-081/46-293/46-294

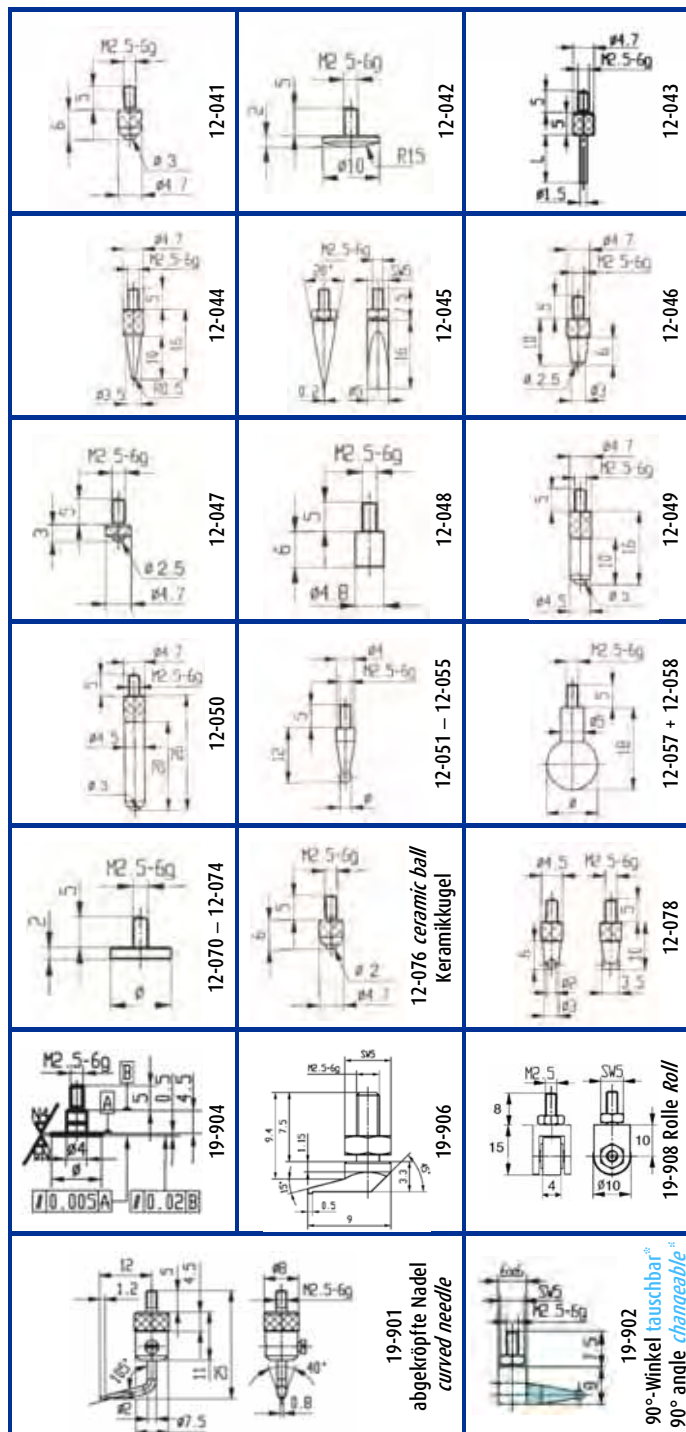

Art.-Nr. Order no.	Ø (mm)	Stiftlänge pin length	EUR
12-041			1,50
12-042			4,90
12-043	1,5	11 mm	6,30
12-043-020		20 mm	8,70
12-043-030		30 mm	9,40
12-043-050		50 mm	9,80
12-044			4,50
12-045		7,90	
12-046		2,90	
12-047		2,70	
12-048		3,90	
12-049		4,00	
12-050		4,00	
12-051	2,0		6,10
12-052	3,0		6,10
12-053	4,0		6,10
12-054	5,0		6,10
12-055	6,0		7,90
12-057	8,0		8,60
12-058	10,0		8,60
12-070	8,0		11,90
12-071	10,0		4,20
12-072	15,0		12,90
12-073	20,0		16,00
12-074	30,0		16,90
12-076			3,90
12-078			9,90
19-901			51,50
19-902*			15,80
19-904	Ø10x0,5		89,50
19-906			29,50
19-908	Ø10x4		32,50

*Lieferung mit Einsatz 12-051, tauschbar gegen anderen Einsatz M2,5
**Delivery with insert 12-051, changeable against other insert M2.5*

Weitere Einsätze auf Anfrage!
Further inserts on request!

Messuhren Dial gauges

Mikro-Hartmetall-Einsätze für Messuhr *Micro carbide metal measuring tips for dial gauges*

Aufnahmegewinde M2,5 | hartmetallbestückt | passend für alle gängigen Messuhren (analog/digital)
Fixing thread M2.5 | carbide metal measuring face | suitable for all current dial gauges (analog/digital)

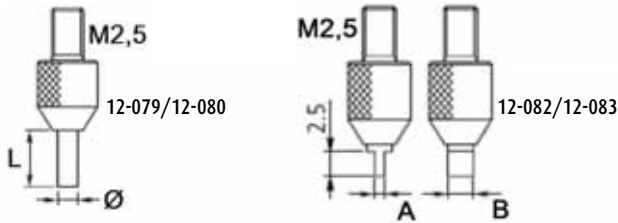

Art.-Nr. Order no.	Typ type	Abmessung dimension	EUR
12-079	Nadel (ØxL) pin	Ø0,5x3 mm	14,80
12-080		Ø1x3 mm	14,80
12-082	Schneide (AxB) blade	0,4x2 mm	16,80
12-083		0,6x2 mm	16,80

Messuhrverlängerungen *Extension rods for dial gauges*

Anschlussgewinde M2,5 | rostfreier Stahl | einzeln oder im Satz | Aufbewahrungsbox (nur 12-092)
Fixing thread M2.5 | stainless steel | single or set | box (only 12-092)



12-092

Art.-Nr. Order no.	Ausführung type	Durchmesser diameter	EUR
12-092	Satz 10tlg. set 10 pcs 10/20/30/40/50/60/70/80/90/100 mm	Ø4,5 mm	23,80
12-093-XXX	einzel (XXX=Größe, z. B. „12-093-025“ = 25 mm) single (XXX=size, e. g. „12-093-025“ = 25 mm) 10/15/20/25/30/35/40/45/50/55/ 60/65/70/75/80/85/90/95/100 mm	Ø4 mm	3,45

Mess-Winkelköpfe für Messuhren *Measuring cross-head for dial gauges*



Hub 4 mm | Messuhraufnahme Ø8 mm | Made in Germany
Range 4 mm | Seat hole Ø8 mm | Made in Germany

Funktionsprinzip:
 Messuhr + Winkelkopf + Schraubeinsatz + Einsatz M2,5

*Functional principle:
 Dial gauge + cross-head
 + screw-plug cartridge
 + measuring tip M2.5*

Winkelköpfe Cross-heads		
Art.-Nr. Order no.	Winkel Angle	EUR
19-921	90°	168,00
19-922	45°	168,00

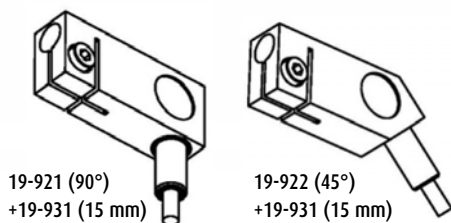

19-921 (90°)
+19-931 (15 mm)

19-922 (45°)
+19-931 (15 mm)

Schraubeinsätze Screw-plug cartridge		
Art.-Nr. Order no.	Länge L Length L	EUR
19-931	15 mm	124,00
19-932	25 mm	124,00
19-933	50 mm	124,00
19-934	75 mm	124,00
19-935	100 mm	171,00

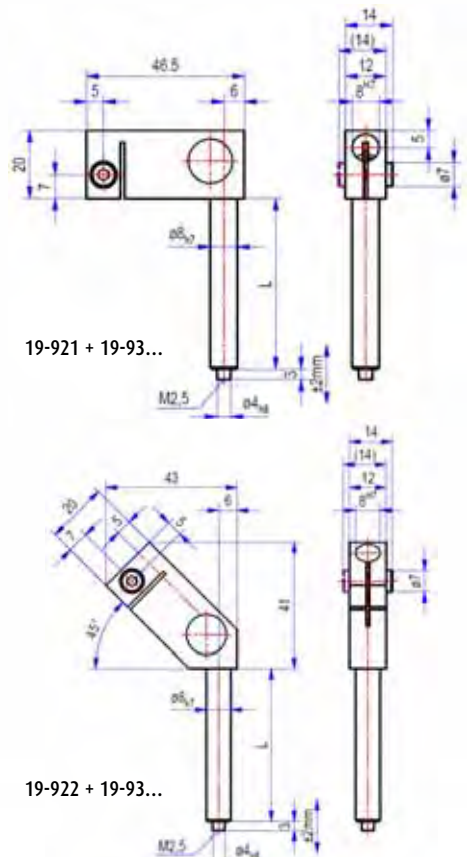

19-921 + 19-93...

19-922 + 19-93...

Messuhren

Dial gauges

Prüfstiftaufnahme für Messuhren *Pin gauge adaptor for dial gauges*

Spannhülse für Prüfstifte oder Nadeln Ø0,5 bis Ø1,4 mm | Aufnahmegewinde M2,5 | passend für alle gängigen Messuhren (analog/digital) und alle Messschieber für Wechsel-Einsätze M2,5

Retaining bush for pin gauges or needles Ø0.5 to Ø1.4 mm | Fixing thread M2.5 | suitable for all current dial gauges (analog/digital) and all calipers for changeable inserts M2.5



Anwendungsbeispiel
Example of use

Art.-Nr. Order no.	EUR
19-951	59,00

Toleranzmarkierung-Aufkleber für Messuhren *Dial gauge limit mark sticker*

für analoge Messuhren ab Ø52 mm | transparente, mit Schere zuschneidbare Folie | selbstklebend, ablösbar | Verpackungseinheit = 10 Stück
for analog dial gauges from Ø52 mm | transparent foil for cutting with scissors | self-adhesive, removable | packing unit = 10 pieces

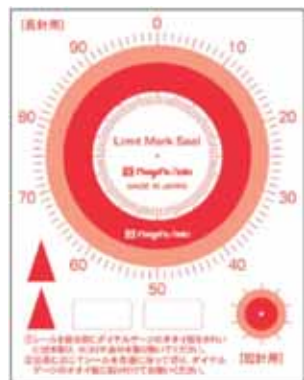

Anwendungsbeispiel
Example of use

Art.-Nr. Order no.	EUR
12-099	4,90

Tiefenmessbrücke *Depth measuring base*

Messuhrenaufnahme Ø8 mm | mattverchromt | Messflächen geschliffen und geläpft
for dial gauges with shank Ø8 mm | satin chrome finished | measuring surface lapped



12-097

Art.-Nr. Order no.	Abmessung dimension	Gesamthöhe total height	EUR
12-096	63x17 mm	34 mm	33,50
12-097	100x16 mm	37 mm	34,50
12-098	150x16 mm	39,50	

KÄFER Tiefenmessbrücke *Depth measuring base*

Messuhrenaufnahme Ø8 mm H7 | mattverchromt | gehärtet | Messflächen fein geläpft | Ebenheit DIN 874/0
for dial gauges with shank Ø8 mm H7 | satin chrome finished | hardened | measuring surface fine lapped | evenness DIN 874/0



19-596

Art.-Nr. Order no.	Abmessung dimension	EUR
19-595	50x16 mm	61,50
19-596	80x16 mm	61,50
19-597	100x16 mm	61,50
19-598	120x20 mm	71,00
19-599	150x20 mm	98,00

Sonderabmessungen auf Anfrage!
Customized dimensions on request!

Messuhren Dial gauges

Digital-Messuhr 0,01 mm *Digital dial gauge 0.01 mm*



12-111

Auflösung 0,01 mm / 0,0005 inch | Gehäuse Ø58 mm | Schaft Ø8 h6 | Aufbewahrungsbox
 Reading 0.01 mm / 0.0005 inch | Housing Ø58 mm | shank Ø8 h6 | box

Art.-Nr. Order no.	Messbereich Range	Genauigkeit Accuracy	EUR
12-111	12,5 mm	0,025 mm	47,50
12-112	25 mm		59,50
12-113	50 mm		129,00
12-114	100 mm		372,00

Digital-Messuhr 0,001 mm *Digital dial gauge 0.001 mm*



12-142

Auflösung 0,001 mm / 0,00005 inch | Gehäuse Ø58 mm | Schaft Ø8 h6 | Aufbewahrungsbox
 Reading 0.001 mm / 0.00005 inch | Housing Ø58 mm | shank Ø8 h6 | box

Art.-Nr. Order no.	Messbereich Range	Genauigkeit Accuracy	EUR
12-142	12,5 mm	0,005 mm	112,00
12-143	25 mm	0,006 mm	139,00
12-144	50 mm	0,008 mm	197,00

Digital-Messuhr klein *Digital dial gauge small*



12-152

Messbereich 5 mm | Gehäuse Ø41,5 mm | Gehäuse-Dicke 25 mm | Gesamtlänge 96 mm | Schaft Ø8 | Aufbewahrungsbox
 Range 5 mm | Housing Ø41.5 mm | thickness of housing 25mm | Overall length 96 mm | shank Ø8 | box

Art.-Nr. Order no.	Auflösung Reading	Genauigkeit Accuracy	EUR
12-151	0,01 mm	0,025 mm	62,50
12-152	0,001 mm	0,005 mm	128,00

01

02

03

04

05

06

07

08

09

10

11

12

13

14

15

Messuhren Dial gauges

Digital-Messuhr mit Toleranz-Anzeige *Digital dial gauge with displayed tolerance*



Auflösung 0,001 mm / 0,00005 inch | Gehäuse Ø61 mm | Schaft Ø8 h6 | Aufbewahrungsbox
 Reading 0.001 mm / 0.00005 inch | Housing Ø61 mm | shank Ø8 h6 | box



Anzeige um 270° drehbar
 Display rotatable 270°

Art.-Nr. Order no.	Messbereich Range	Genauigkeit Accuracy	EUR
12-121	12,5 mm	0,015 mm	167,00

Digital-Messuhr IP65 (wasserdicht) *Digital dial gauge IP65 (waterproof)*

Wasserdicht gemäß IP65 | Gehäuse Ø58 mm | Schaft Ø8 h6 | Aufbewahrungsbox
 Waterproof according to IP65 | Housing Ø58 mm | shank Ø8 h6 | box



12-127

Art.-Nr. Order no.	Auflösung Reading	Messbereich Range	Genauigkeit Accuracy	EUR
12-123		12,5 mm		67,50
12-124	0,01 mm	25 mm	0,025 mm	79,50
12-125		50 mm		195,00
12-127	0,001 mm	12,5 mm	0,005 mm	153,00

Digital-Messuhr mit Datenausgang *Digital dial gauge with data output*

Auflösung 0,01 mm / 0,0005 inch | Gehäuse Ø58 mm | Schaft Ø8 h6 | Datenausgang RB5 | Aufbewahrungsbox
 Reading 0.01 mm / 0.0005 inch | Housing Ø58 mm | shank Ø8 h6 | data output RB5 | box



Art.-Nr. Order no.	Messbereich Range	Genauigkeit Accuracy	EUR
12-103	12,5 mm	0,025 mm	61,50

Zubehör für Datenübertragung *Accessories for data transfer*

Für alle Messgeräte mit Datenausgang RB5 | am Messgerät angezeigter Messwert wird einfach per Tastendruck an einen PC (Windows 10) übertragen und direkt in ein Messprotokoll, CAQ-System, Excel-Tabelle o. ä. eingefügt | verschiedene Optionen einstellbar | Auflösung 0,01 mm

For all measuring devices with data output RB5 | displayed value from measuring device is simply transferred by keystroke to a PC (Windows 10) into a measurement report, CAQ-system or Excel table, etc. | various options adjustable | resolution 0.01 mm



Messgerät (RB5)

PC (USB)

Art.-Nr. Order no.	Artikel Range	EUR
10-981	USB-Interface (2,4 m)	108,00
10-991	Anschlußkabel RB5 (1 m) Connection cable RB5	13,50

Messuhren

Dial gauges

HELIOS-PREISSER Digital-Messuhr *Digital dial gauge*

großes Display 12 mm | Schaft Ø8 mm | Gehäuse Ø60 mm | variabler Datenausgang RS232 / Digimatic / USB | Schutzart IP52 | Funktionsumfang: QuickStart-Elektronik (automatisches Einschalten / gespeicherte Nullposition), Zählrichtungsumkehr, Tastensperre

large display 12 mm | shank Ø8 mm | housing Ø60 mm | variable data output RS232 / Digimatic / USB | protection class IP52 | functions: Quick-Start-electronic (automatic switch on / saved position of zero), direction of counting switchable, key lock



Art.-Nr. Order no.	Messbereich Range	Auflösung Reading	Genauigkeit Accuracy	EUR
46-501	12,5 mm	0,01 mm	0,02 mm	139,00
46-502		0,005 mm	0,015 mm	175,00
46-503		0,001 mm	0,005 mm	289,00

HELIOS-PREISSER Digital-Präzisionsmessuhr **0,01 mm** mit Datenausgang *Digital dial gauge 0.01 mm with data output*

Auflösung 0,01 mm | Schaft Ø8 mm | Anzeige um 280° drehbar | Aluminiumgehäuse Ø60 mm | variabler Datenausgang RS232 / Digimatic / USB | Funktionsumfang: QuickStart-Elektronik (automatisches Einschalten / gespeicherte Nullposition), Absolut-Funktion, Toleranzfunktion, Zählrichtungsumkehr, Faktoreingabe, Tastensperre

Reading 0.01 mm | shank Ø8 mm | display rotatable 280° | aluminium housing Ø60 mm | variable data output RS232 / Digimatic / USB | functions: Quick-Start-electronic (automatic switch on / saved position of zero), Absolute-function, Tolerance-function, direction of counting switchable, input of factor, key lock



Art.-Nr. Order no.	Messbereich Range	Genauigkeit Accuracy	EUR
46-511	12,5 mm	0,02 mm	283,00
46-512	25 mm		359,00
46-513	50 mm		588,00
46-514	100 mm		753,00

HELIOS-PREISSER Digital-Präzisionsmessuhr **0,001 mm** mit Datenausgang *Digital dial gauge 0.001 mm with data output*

Auflösung 0,001 mm | Schaft Ø8 mm | Anzeige um 280° drehbar | Aluminiumgehäuse Ø60 mm | variabler Datenausgang RS232 / Digimatic / USB | Funktionsumfang: QuickStart-Elektronik (automatisches Einschalten / gespeicherte Nullposition), Absolut-Funktion, Toleranzfunktion, Zählrichtungsumkehr, Faktoreingabe, Tastensperre

Reading 0.001 mm | shank Ø8 mm | display rotatable 280° | aluminium housing Ø60 mm | variable data output RS232 / Digimatic / USB | functions: Quick-Start-electronic (automatic switch on / saved position of zero), Absolute-function, Tolerance-function, direction of counting switchable, input of factor, key lock



Art.-Nr. Order no.	Messbereich Range	Genauigkeit Accuracy	EUR
46-521	12,5 mm	0,004 mm	338,00
46-522	25 mm		372,00
46-523	50 mm	0,007 mm	656,00
46-524	100 mm	0,008 mm	812,00

Messuhren Dial gauges

HELIOS-PREISSER Digital-Präzisionsmessuhr 0,0005 mm mit Funk-Datenübertragung Digital dial gauge 0.0005 mm with wireless data output

Auflösung 0,0005 mm | Schaft Ø8 mm | Anzeige um 280° drehbar | Aluminiumgehäuse Ø60 mm | Schutzart IP42 | integrierter Funksender „Integrated Wireless“ und (kabelgebundener) variabler Datenausgang RS232 / Digimatic / USB | Funktionsumfang: QuickStart-Elektronik (automatisches Einschalten / gespeicherte Nullposition), Absolut-Funktion, Toleranzfunktion, Preset-Funktion (Messwertvoreinstellung), Zählrichtungsumkehr, Faktoreingabe, Tastensperre

Reading 0.0005 mm | shank Ø8 mm | display rotatable 280° | aluminium housing Ø60 mm | protection class IP42 | data output with "Integrated Wireless" and variable data output (for cable connection) RS232 / Digimatic / USB | functions: Quick-Start-electronic (automatic switch on / saved position of zero), Absolute-function, Tolerance-function, preset-function, direction of counting switchable, input of factor, key lock



Art.-Nr. Order no.	Messbereich Range	Genauigkeit Accuracy	EUR
46-531	12,5 mm	0,004 mm	383,00
46-532	25 mm		417,00

HELIOS-PREISSER Datenübertragungskabel für variablen Datenausgang Data transfer cable for variable data output

für alle HELIOS-PREISSER Messgeräte mit variablem Datenausgang | Länge 2 m | mit Datenübertragungstaste | Software „MarCom Professional“ für Windows 7/8/10 zum Übertragen der Messwerte in Anwendungen kostenlos downloadbar auf www.helios-preisser.de

For all HELIOS-PREISSER measuring tools with variable data output | length 2 m | with data transfer button | software "MarCom Professional" for Windows 7/8/10 for transferring measuring values into applications free download at www.helios-preisser.de

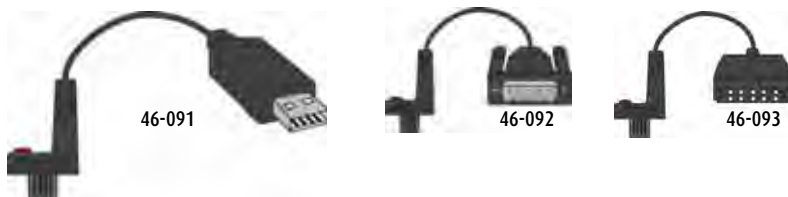

Art.-Nr. Order no.	Schnittstelle Interface	EUR
46-091	USB	69,50
46-092	RS232	49,00
46-093	Digimatic	62,50

Weitere Informationen und Zubehör zum Thema Datenübertragung finden Sie in Kapitel 15!
Further information and accessories related to data transfer can be found in chapter 15!

HELIOS-PREISSER USB-Empfänger für Funk-Datenübertragung USB receiver for wireless data transfer

für bis zu 8 HELIOS-PREISSER Messgeräte mit „Integrated Wireless“ | Funkdistanz bis zu 6 m | USB-Anschluss | Software „MarCom Professional“ für Windows 7/8/10 zum Übertragen der Messwerte in Anwendungen kostenlos downloadbar auf www.helios-preisser.de

For up to 8 HELIOS-PREISSER measuring tools with "Integrated Wireless" | radio distance up to 6 m | USB interface | software "MarCom Professional" for Windows 7/8/10 for transferring measuring values into applications free download at www.helios-preisser.de



Art.-Nr. Order no.	EUR
46-099	93,50

Weitere Informationen und Zubehör zum Thema Datenübertragung finden Sie in Kapitel 15!
Further information and accessories related to data transfer can be found in chapter 15!

Messuhren Dial gauges

SYLVAC Digital-Präzisionsmessuhr 0,01 mm mit Datenausgang *Digital precision dial gauge 0.01 mm with data output*

Auflösung 0,01 mm | Schaft Ø8 h6 | wasser- und kühlmittelfest | robuster Aufbau | großer Funktionsumfang: Umschalten mm/inch, Preset, Umschalten der Messrichtung, Hold, Min/Max/Delta, Toleranzen, konfigurierbar über PC | personalisierbare Taste für wählbare Funktion | Datenausgang „Proximity“ RS232/USB | Swiss Made
Reading 0.01 mm | shank Ø8 h6 | water and coolant resistant | robust construction | many functions: switch mm/inch, preset, switch measuring direction, hold, min/max/delta, tolerances, configurable via PC | key for personalized selectable function | data interface "Proximity" RS232/USB | Swiss made



19-304

Art.-Nr. Order no.	Messbereich Range	Genauigkeit Accuracy	EUR
19-303	12,5 mm	0,01 mm	299,00
19-304	25 mm	0,01 mm	345,00
19-305	50 mm	0,02 mm	618,00
19-306	100 mm	0,02 mm	831,00
19-307	150 mm	0,02 mm	1093,00

Informationen und Zubehör zum Thema Datenübertragung finden Sie in Kapitel 15!
Information and accessories related to data transfer can be found in chapter 15!

SYLVAC Digital-Präzisionsmessuhr 0,001 mm mit Datenausgang *Digital precision dial gauge 0.001 mm with data output*

Auflösung 0,001 mm | Schaft Ø8 h6 | wasser- und kühlmittelfest | robuster Aufbau | großer Funktionsumfang: Umschalten mm/inch, Preset, Umschalten der Messrichtung, Hold, Min/Max/Delta, Toleranzen, konfigurierbar über PC | personalisierbare Taste für wählbare Funktion | Datenausgang „Proximity“ RS232/USB | Swiss Made
Reading 0.001 mm | shank Ø8 h6 | water and coolant resistant | robust construction | many functions: switch mm/inch, preset, switch measuring direction, hold, min/max/delta, tolerances, configurable via PC | key for personalized selectable function | data interface "Proximity" RS232/USB | Swiss made



19-314

Art.-Nr. Order no.	Messbereich Range	Genauigkeit Accuracy	EUR
19-313	12,5 mm	0,003 mm	384,00
19-314	25 mm	0,004 mm	419,00
19-315	50 mm	0,005 mm	681,00
19-316	100 mm	0,006 mm	873,00
19-317	150 mm	0,010 mm	1218,00

Informationen und Zubehör zum Thema Datenübertragung finden Sie in Kapitel 15!
Information and accessories related to data transfer can be found in chapter 15!

SYLVAC Digital-Präzisionsmessuhr 0,1 µm mit Datenausgang *Digital precision dial gauge 0.1 µm with data output*

Auflösung 0,0001 mm | Wiederholbarkeit 0,0002 mm | Schaft Ø8 h6 | großer Funktionsumfang: Umschalten mm/inch, Preset, Umschalten der Messrichtung, Hold, Min/Max/Delta, Toleranzen, konfigurierbar über PC | personalisierbare Taste für wählbare Funktion | Datenausgang „Proximity“ RS232/USB | Swiss Made
Reading 0.0001 mm | repeatability 0.0002 mm | shank Ø8 h6 | many functions: switch mm/inch, preset, switch measuring direction, hold, min/max/delta, tolerances, configurable via PC | key for personalized selectable function | data interface "Proximity" RS232/USB | Swiss made



19-324

Art.-Nr. Order no.	Messbereich Range	Genauigkeit Accuracy	EUR
19-324	25 mm	0,0013 mm	1156,00
19-325	50 mm	0,0015 mm	1426,00
19-326	100 mm	0,0022 mm	1712,00

Informationen und Zubehör zum Thema Datenübertragung finden Sie in Kapitel 15!
Information and accessories related to data transfer can be found in chapter 15!

Messuhren Dial gauges

SYLVAC Digital-Kleinstmessuhr *Digital dial gauge small*

Messbereich 12,5 mm | Schaft Ø8 h6 | wasserdicht gemäß IP54 | Gehäuse Ø45 mm | großer Funktionsumfang: Umschalten mm/inch, Preset, Umschalten der Messrichtung, Relativ- oder Absolut-Modus | automatisches Ausschalten | Datenausgang „Power“ RS232/USB | Swiss Made

Range 12.5 mm | shank Ø8 h6 | waterproof according to IP54 | housing Ø45 mm | many functions: switch mm/inch, preset, switch measuring direction, relative or absolute mode | automatic power-off | data interface "Power" RS232/USB | Swiss made



19-331

Art.-Nr. Order no.	Auflösung Reading	Genauigkeit Accuracy	EUR
19-331	0,01 mm	0,01 mm	228,00
19-332	0,001 mm	0,004 mm	328,00

Informationen und Zubehör zum Thema Datenübertragung finden Sie in Kapitel 15!
Information and accessories related to data transfer can be found in chapter 15!

SYLVAC Digital-Präzisionsmessuhr Bluetooth® Datenausgang *Digital precision dial gauge Bluetooth® data output*

Auflösung 0,001 mm | Schaft Ø8 h6 | wasser- und kühlmittelfest IP54 | robuster Aufbau (Gehäuse aus Aluminium) | großer Funktionsumfang: Umschalten mm/inch, Preset, Umschalten der Messrichtung, Hold, Min/Max/Delta, Toleranzen, konfigurierbar über PC | personalisierbare Taste für wählbare Funktion | Datenausgang „Proximity“ RS232/USB (kabelgebunden) und Bluetooth (kabellos) | Swiss Made

Reading 0.001 mm | shank Ø8 h6 | water and coolant resistant IP54 | robust construction (housing from aluminium) | many functions: switch mm/inch, preset, switch measuring direction, hold, min/max/delta, tolerances, configurable via PC | key for personalized selectable function | data interface "Proximity" RS232/USB (tethered) and Bluetooth (wireless) | Swiss made



19-381

Art.-Nr. Order no.	Messbereich Range	Genauigkeit Accuracy	EUR
19-381	12,5 mm	0,003 mm	488,00
19-382	25 mm	0,004 mm	520,00
19-383	50 mm	0,005 mm	880,00
19-384	100 mm	0,006 mm	1085,00

SYLVAC USB-Dongle Bluetooth® *USB dongle Bluetooth®*



USB-Empfangseinheit für Windows 10 | für bis zu 8 SYLVAC-Messgeräte mit Bluetooth-Datenausgang | automatische Erkennung der Messgeräte | inkl. Software „Vmux“

USB receiver for Windows | for up to 8 SYLVAC measuring tools with Bluetooth data output | automatic detection of measuring tools | incl. Software "Vmux"



Art.-Nr. Order no.	EUR
19-399	79,50

Weitere Informationen und Zubehör zum Thema Datenübertragung finden Sie in Kapitel 15!
Further information and accessories related to data transfer can be found in chapter 15!

Messuhren Dial gauges

BENZING Rundlaufprüfgerät Bench center



aus Spezialguss, feinstgeschliffen und justiert | Aufnahmespitzen aus gehärtetem Stahl | Messuhr-Aufnahme Ø8 mm | Ebenheit Grundplatte DIN876/1 | Lieferung ohne Messuhr
made from special cast, precision ground and calibrated | center punch from hardened steel | dial gauge stand with seat Ø8 mm | evenness of base plate DIN876/1 | without dial gauge



Art.-Nr. Order no.	Spitzenweite distance between centers	Spitzenhöhe heights of centers	Gesamtlänge total length	Gewicht weight	EUR
49-001	200 mm	50 mm	350 mm	8 kg	619,00
49-004	350 mm	75 mm	500 mm	12 kg	819,00

Zubehör accessories:



Art.-Nr. Order no.	Beschreibung description	EUR
49-021	Hartmetall-Spitzen (Paar) carbide metal centers (pair)	89,00
49-026	Abrollbock-Paar rolling support pair (für for Ø2-40 mm)	208,00
49-027	Abrollbock-Paar einseitig höhenverstellbar, für Ø2-32 mm Rolling support (pair), partial height adjustable, for Ø2-32	433,00

Rundlaufprüfgerät mit großer Spitzenweite Bench center with large distance between centers



Pinole und Körnerspitze aus gehärtetem Stahl | Gestell und Reitstöcke aus Guss | Spitzenhöhe 176 mm | Aufnahmekonus MK2 | Messuhrenhalter Aufnahme Ø8 mm | Genauigkeit 0,02 mm
sleeve and center punch from hardened steel | base and tail stock from cast iron | height of centers 176 mm | cone MK2 | dial gauge stand with seat Ø8 mm | accuracy 0.02 mm

Art.-Nr. Order no.	Spitzenweite distance between centers	Gesamtlänge total length	Gewicht weight	EUR
30-521	500 mm	920 mm	80 kg	988,00
30-523	1000 mm	1420 mm	85 kg	1255,00

HELIOS-PREISSER spitzenloses Rundlaufprüfgerät Centerless bench center

Scheibenböcke auf Grundplatte verschiebbar, einseitig um 30 mm höhenverstellbar (zum Durchmesser ausgleichen) | spielfrei gelagerte Abrollscheiben Ø120 mm | Genauigkeit <0,005 mm | Scheibenabstand max. 400 mm | für Werkstücke bis Ø250 mm / 25 kg | Made in Germany | Lieferung mit Messstativ, ohne Messuhr
disc supports movable on base plate, one side adjustable in height 30 mm (for compensation of diameters) | zero-play roller wheels Ø120 mm | accuracy <0.005 mm | disc distance max. 400 mm | for workpieces up to Ø250 mm / 25 kg | Made in Germany | delivery with measuring stand, without dial gauge



Art.-Nr. Order no.	EUR
46-595	3069,00

Messuhren Dial gauges

Fühlhebelmessgerät *Dial test indicator*

Einspannschaft $\varnothing 6 + \varnothing 8$ mm und Schwalbenschwanzaufnahme | Messeinsatz $\varnothing 2 \times 11,6$ mm | stoßgeschützt | DIN 2270 | automatische Umkehr der Messrichtung | Aufbewahrungsbox

connector $\varnothing 6 + \varnothing 8$ mm and dovetail | measuring tip $\varnothing 2 \times 11.6$ mm | shock proof | DIN 2270 | automatic inversion of measuring direction | box



Art.-Nr. Order no.	Messbereich Range	Ableseung Reading	Gehäuse housing	EUR
12-171	0,8 mm	0,01 mm	Ø32 mm	34,50
12-172	0,2 mm	0,002 mm		52,50
12-173	0,8 mm	0,01 mm	Ø40 mm	39,50
12-174	0,2 mm	0,002 mm		56,50

Fühlhebelmessgerät **vertikal** *Dial test indicator vertical*



Einspannschaft $\varnothing 6 + \varnothing 8$ mm und Schwalbenschwanzaufnahme | Messeinsatz $\varnothing 2 \times 11,6$ mm | stoßgeschützt | DIN 2270 | automatische Umkehr der Messrichtung | Aufbewahrungsbox

connector $\varnothing 6 + \varnothing 8$ mm and dovetail | measuring tip $\varnothing 2 \times 11.6$ mm | shock proof | DIN 2270 | automatic inversion of measuring direction | box

Art.-Nr. Order no.	Messbereich Range	Ableseung Reading	Gehäuse housing	EUR
12-181	0,8 mm	0,01 mm	Ø32 mm	42,50
12-182	0,2 mm	0,002 mm		61,00
12-183	0,8 mm	0,01 mm	Ø40 mm	49,50
12-184	0,2 mm	0,002 mm		69,00

Fühlhebelmessgerät mit **Rubin-Messtaster** *Dial test indicator with ruby feeler*

Einspannschaft $\varnothing 6 + \varnothing 8$ mm und Schwalbenschwanzaufnahme | Messeinsatz $\varnothing 2 \times 11,6$ mm | stoßgeschützt | DIN 2270 | automatische Umkehr der Messrichtung | Aufbewahrungsbox

connector $\varnothing 6 + \varnothing 8$ mm and dovetail | measuring tip $\varnothing 2 \times 11.6$ mm | shock proof | DIN 2270 | automatic inversion of measuring direction | box



Art.-Nr. Order no.	Messbereich Range	Ableseung Reading	Gehäuse housing	EUR
12-166	0,8 mm	0,01 mm	Ø32 mm	44,50
12-167			Ø40 mm	47,00

Fühlhebelmessgerät mit **langem Messtaster** *Dial test indicator with long feeler*

Einspannschaft $\varnothing 6 + \varnothing 8$ mm und Schwalbenschwanzaufnahme | Messeinsatz $\varnothing 2$ mm | stoßgeschützt | Gehäuse $\varnothing 40$ mm | Genauigkeit 0,02 mm | automatische Umkehr der Messrichtung | Aufbewahrungsbox

connector $\varnothing 6 + \varnothing 8$ mm and dovetail | measuring tip $\varnothing 2$ mm | shock proof | housing $\varnothing 40$ mm | accuracy 0.02 mm | automatic inversion of measuring direction | box



Art.-Nr. Order no.	Messbereich Range	Ableseung Reading	Tasterlänge length of feeler	EUR
12-161	1,0 mm	0,01 mm	22,5 mm	48,50
12-162			36,0 mm	57,00

Messuhren

Dial gauges

KÄFER Fühlhebelmessgerät *Dial test indicator*

Messbereich 0,8 mm | Ablesung 0,01 mm | Einspannschaft Ø8 mm und Schwalbenschwanzaufnahme | Messeinsatz Ø2x12,8 mm | stoßgeschützt | DIN 2270 | Made in Germany | Aufbewahrungsbox

Range 0.8 mm | Reading 0.01 mm | connector Ø8 mm and dovetail | measuring tip Ø2x12.8 mm | shock proof | DIN 2270 | Made in Germany | box



19-701

Art.-Nr. Order no.	Gehäuse housing	EUR
19-701	Ø32 mm	79,50
19-702	Ø40 mm	84,00

Ersatztaster *spare tips*

Art.-Nr. Order no.	EUR
19-753	7,80

KÄFER Fühlhebelmessgerät mit langem Messtaster *Dial test indicator with long feeler*

Messbereich 0,5 mm | Ablesung 0,01 mm | Gehäuse Ø32 mm | Einspannschaft Ø8 mm und Schwalbenschwanzaufnahme | Messeinsatz Ø2x35,7 mm | DIN 2270 | Made in Germany | Aufbewahrungsbox

Range 0.5 mm | Reading 0.01 mm | housing Ø32 mm | connector Ø8 mm and dovetail | measuring tip Ø2x35.7 mm | DIN 2270 | Made in Germany | box



Art.-Nr. Order no.	EUR
19-711	117,00

Ersatztaster *spare tips*

Art.-Nr. Order no.	EUR
19-762	11,90

KÄFER Fühlhebelmessgerät 0,001 mm *Dial test indicator 0.001 mm*

Messbereich 0,2 mm | Ablesung 0,001 mm | Gehäuse Ø40 mm | Einspannschaft Ø8 mm und Schwalbenschwanzaufnahme | Messeinsatz Ø2x12,8 mm | DIN 2270 | Made in Germany | Aufbewahrungsbox

Range 0.2 mm | Reading 0.001 mm | housing Ø40 mm | connector Ø8 mm and dovetail | measuring tip Ø2x12.8 mm | DIN 2270 | Made in Germany | box



Art.-Nr. Order no.	EUR
19-731	119,00

Ersatztaster *spare tips*

Art.-Nr. Order no.	EUR
19-753	7,80

01



02



03



04



05



06



07



08



09



10



11



12



13



14



15



Messuhren Dial gauges

Digital-Fühlhebelmessgerät *Digital dial test indicator*

Messbereich $\pm 0,5$ mm | Auflösung 0,001 mm | Genauigkeit 0,02 mm | drehbare Digitalanzeige mit Laufbalken | Messfunktionen: Standard / Maximum / Minimum | Einspannschaft $\varnothing 4 + \varnothing 8$ mm und Schwalbenschwanzaufnahme | Messeinsatz $\varnothing 2 \times 15$ mm | automatische Umkehr der Messrichtung | Aufbewahrungsbox



Range ± 0.5 mm | Reading 0.001 mm | Accuracy 0.02 mm | rotatable digital display with position bars | measuring functions: standard / maximum / minimum | connector $\varnothing 4 + \varnothing 8$ mm and dovetail | measuring tip $\varnothing 2 \times 15$ mm | automatic inversion of measuring direction | box

Art.-Nr. Order no.	EUR
12-191	139,00

SYLVAC Digital-Fühlhebelmessgerät **Bluetooth®** Datenausgang *Digital dial test indicator Bluetooth® data output*

Messbereich 0,8 mm | Auflösung 0,001 mm | drehbares Gehäuse $\varnothing 45$ mm | Einspannschaft $\varnothing 8$ mm und Schwalbenschwanzaufnahme | Messeinsatz $\varnothing 2 \times 12,5$ mm | Genauigkeit 0,004 mm | wasserdicht gemäß IP54 | Funktionen: Nulleinstellung, Min/Max/Delta, Preset | Datenausgang „Power“ RS232/USB (kabelgebunden) und Bluetooth (kabellos) | Swiss Made | inkl. Hersteller-Prüfprotokoll



Range 0.8 mm | reading 0.001 mm | rotatable housing $\varnothing 45$ mm | connector $\varnothing 8$ mm and dovetail | measuring tip $\varnothing 2 \times 12.5$ mm | accuracy 0.004 mm | waterproof according to IP54 | functions: setting zero, min/max/delta, preset | data interface "Power" RS232/USB (tethered) and Bluetooth (wireless) | Swiss made | incl. Manufacturer's inspection certificate

Art.-Nr. Order no.	EUR
19-342	398,00

Informationen und Zubehör zum Thema Datenübertragung finden Sie in Kapitel 15!
Information and accessories related to data transfer can be found in chapter 15!

SYLVAC Digital-Fühlhebelmessgerät **langer Taster, Bluetooth®** *Digital dial test indicator long feeler, Bluetooth®*

Messbereich 2 mm | Auflösung 0,001 mm | drehbares Gehäuse $\varnothing 45$ mm | Einspannschaft $\varnothing 8$ mm und Schwalbenschwanzaufnahme | Messeinsatz $\varnothing 2 \times 36,5$ mm | Genauigkeit 0,01 mm | wasserdicht gemäß IP54 | Funktionen: Nulleinstellung, Min/Max/Delta, Preset | Datenausgang „Power“ RS232/USB (kabelgebunden) und Bluetooth (kabellos) | Swiss Made | inkl. Hersteller-Prüfprotokoll



Range 2 mm | reading 0.001 mm | rotatable housing $\varnothing 45$ mm | connector $\varnothing 8$ mm and dovetail | measuring tip $\varnothing 2 \times 36.5$ mm | accuracy 0.01 mm | waterproof according to IP54 | functions: setting zero, min/max/delta, preset | data interface "Power" RS232/USB (tethered) and Bluetooth (wireless) | Swiss made | incl. Manufacturer's inspection certificate

Art.-Nr. Order no.	EUR
19-343	455,00

Informationen und Zubehör zum Thema Datenübertragung finden Sie in Kapitel 15!
Information and accessories related to data transfer can be found in chapter 15!

SYLVAC USB-Dongle Bluetooth® *USB dongle Bluetooth®*



USB-Empfängereinheit für Windows 10 | für bis zu 8 SYLVAC-Messgeräte mit Bluetooth-Datenausgang | automatische Erkennung der Messgeräte | inkl. Software „Vmux“



USB receiver for Windows | for up to 8 SYLVAC measuring tools with Bluetooth data output | automatic detection of measuring tools | incl. Software "Vmux"

Art.-Nr. Order no.	EUR
19-399	79,50

Messuhren Dial gauges

Taschendickenmessgerät *Pocket thickness gauge*



für einfache, schnelle Messungen | Ablesung 0,1 mm | Genauigkeit 0,1 mm | Messeinsatz Ø10 mm, flach
for simple, quick measurements | Reading 0.1 mm | Accuracy 0.1 mm | measuring insert Ø10 mm, flat

Art.-Nr. Order no.	Messbereich Range	Ausladung throat depth	EUR
13-010	10 mm	15 mm	22,80
13-011	20 mm	20 mm	27,50

KÄFER Taschendickenmessgerät *Pocket thickness gauge*



für einfache, schnelle Messungen | Ablesung 0,1 mm | Messeinsatz Ø6,35 mm, flach | Made in Germany
for simple, quick measurements | Reading 0.1 mm | measuring insert Ø6.35 mm, flat | Made in Germany



Art.-Nr. Order no.	Messbereich Range	Ausladung throat depth	EUR
19-651	10 mm	15 mm	52,50

Dicken-Messgerät *Thickness gauge*



Ablesung 0,01 mm | Messuhr 10 mm | Taster: rostfreier Stahl | Bügel: Gusseisen lackiert | Aufbewahrungsbox
Reading 0.01 mm | dial gauge 10 mm | rod and disc made of stainless steel | frame made of cast iron | box

Form A:

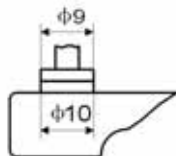

Form B:

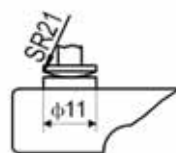

Art.-Nr. Order no.	Messbereich Range	Ausladung throat depth	Tellerform disc form	Genauigkeit Accuracy	EUR
13-001	10 mm	30 mm	A	0,02 mm	49,50
13-002	10 mm	100 mm		0,02 mm	58,50
13-006	10 mm	30 mm	B	0,02 mm	49,50
13-007	10 mm	100 mm		0,02 mm	58,50

KÄFER Dicken-Messgerät mit großer Ausladung *Thickness gauge with large throat depth*



Ablesung 0,01 mm | Messeinsatz Teller Ø10 mm (andere Einsätze auf Anfrage!) | Made in Germany
Reading 0.01 mm | Disc Ø10 mm (other inserts on request!) | Made in Germany



Art.-Nr. Order no.	Messbereich Range	Ausladung throat depth	Genauigkeit Accuracy	EUR
19-602	10 mm	200 mm	0,015 mm	188,00
19-603		300 mm		225,00

Messuhren Dial gauges

Digital-Dicken-Messgerät *Digital thickness gauge*

Auflösung 0,01 mm | Tellergröße Ø14,5 mm | Taster: rostfreier Stahl | Aufbewahrungsbox
Reading 0.01 mm | disc size Ø14.5 mm | rod and disc made of stainless steel | box



Art.-Nr. Order no.	Messbereich Range	Ausladung throat depth	Genauigkeit Accuracy	EUR
13-026	25 mm	25 mm	0,04 mm	99,00

Digital-Wanddicken-Messgerät *Digital section thickness gauge*

Auflösung 0,01 mm | Genauigkeit 0,04 mm | Feder öffnend | Taster: rostfreier Stahl | für Rohrrinnendurchmesser ≥ 4 mm | Aufbewahrungsbox
Reading 0.01 mm | accuracy 0.04 mm | spring opening | rod and disc made of stainless steel | for inside pipe diameter ≥ 4 mm | box

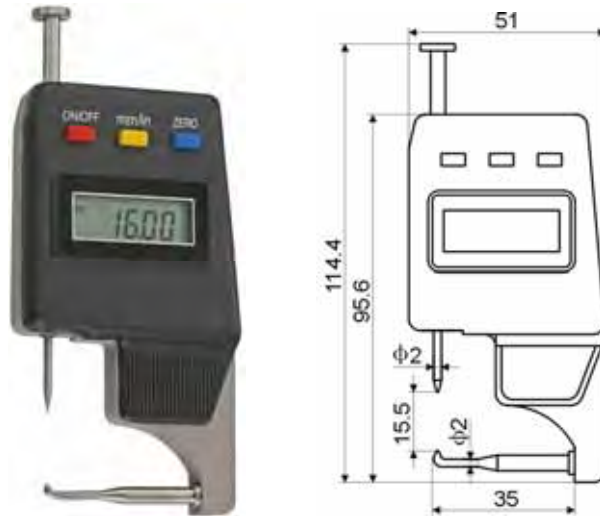

Art.-Nr. Order no.	Messbereich Range	Ausladung throat depth	EUR
13-031	15 mm	35 mm	99,00

KÄFER Digital-Dicken-Messgerät mit großer Ausladung *Digital thickness gauge with large throat depth*

Auflösung 0,001 mm | Messeinsatz Teller Ø10 mm (andere Einsätze auf Anfrage!) | Made in Germany
Reading 0.001 mm | Disc Ø10 mm (other inserts on request!) | Made in Germany



Art.-Nr. Order no.	Messbereich Range	Ausladung throat depth	Genauigkeit Accuracy	EUR
19-611	25 mm	200 mm	0,005 mm	559,00

Messuhren Dial gauges

KÄFER Digitales Foliendicken-Messgerät *Digital foil thickness gauge*



für Folien, Papier u. ä. | Auflösung 0,001 mm | Messeinsatz Ø6,35 mm, flach | Genauigkeit 0,003 mm
 For foils, paper etc. | Reading 0.001 mm | measuring insert Ø6.35 mm, flat | accuracy 0.003 mm



Art.-Nr. Order no.	Messbereich Range	Ausladung throat depth	EUR
19-619	3 mm	30 mm	495,00

KÄFER Sägeschränkmessuhr *Saw tooth offset gauge*

zur Messung der Schränkung von Sägezähnen u. ä. | doppelseitig ablesbar | beidseitige Toleranzmarke
 For measuring the offset of saw teeth etc. | Reading double sided | tolerance marks on both sides



19-681



19-685



Art.-Nr. Order no.	Messbereich Range	Ablesung Reading	EUR
19-681	2 mm	0,1 mm	56,50
19-685		0,01 mm	57,50

Kombinierter Innen-/Außentaster *Combined inside/outside caliper gauge*

zum Messen von Innendurchmesser, Außendurchmesser, Materialstärke, etc. | Ablesung 1 mm | Genauigkeit 0,5 mm | rostfreier Stahl | gehärtete Spitzen | Feststellschraube | Made in Japan
 For measuring inside diameter, outside diameter, material thickness, etc. | Reading 1 mm | Accuracy 0.5 mm | stainless steel | hardened measuring tips | set screw | Made in Japan



13-083

Art.-Nr. Order no.	Messbereich Range	Abmessungen Dimensions A/B/C/D* (mm)	EUR
13-081	100 mm	152/100/98/1,5	59,50
13-083	150 mm	225/150/143/1,5	89,00
13-084	200 mm	300/200/190/2,0	118,00
13-086	300 mm	450/300/268/2,5	197,00

D = Dicke *thickness*

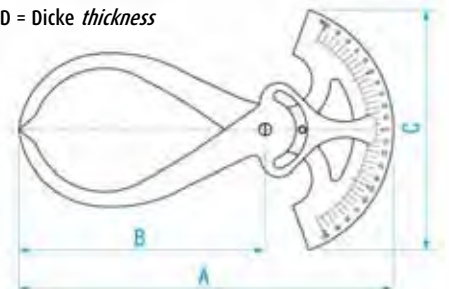

Messuhren Dial gauges

Innen-Schnellmesstaster *Caliper gauge for inside measurements*

Ablesung 0,01 mm | Genauigkeit 0,04 mm | mit Rundspitzen | Anzeige drehbar | Aufbewahrungsbox | Made in Japan
 Reading 0.01 mm | Accuracy 0.04 mm | with rounded contact | display rotatable | box | Made in Japan



13-182

Art.-Nr. Order no.	Messbereich Range	A (mm)	B (mm)	C (mm)	D (mm)	E (mm)	L (mm)	EUR
13-180	3-9 mm	2,3	1,1	2,8	1,1	2,8	40	228,00
13-181	6-18 mm							158,00
13-182	10-22 mm		2,7	4,5	2,3	4,8	42	135,00
13-183	20-32 mm		8	11			42	149,00
13-184	30-42 mm		18	21	4,4	6,7	43	158,00
13-185	40-52 mm		28	31			44	167,00

Anwendungsbeispiel:
Example of use:

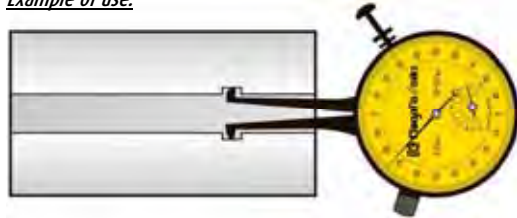

Abmessungen:
Dimensions:

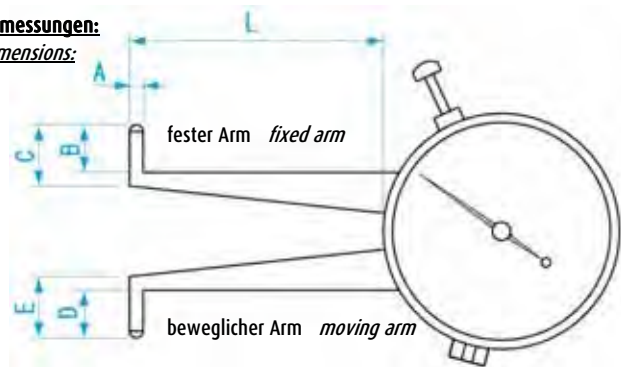

Außen-Schnellmesstaster *Caliper gauge for outside measurements*

Ablesung 0,01 mm | Genauigkeit 0,04 mm | mit Rundspitzen | Anzeige drehbar | Aufbewahrungsbox | Made in Japan
 Reading 0.01 mm | Accuracy 0.04 mm | with rounded contact | display rotatable | box | Made in Japan



13-191

Art.-Nr. Order no.	Messbereich Range	A (mm)	B (mm)	C (mm)	D (mm)	E (mm)	F (mm)	L (mm)	EUR
13-191	0-12 mm	2,3	11,5	14,5			27	40	199,00
13-192	10-22 mm		18,5	20,5	11,5	14,5	45	42	215,00
13-193	20-32 mm		8,5	10,5			49		228,00

Anwendungsbeispiel:
Example of use:

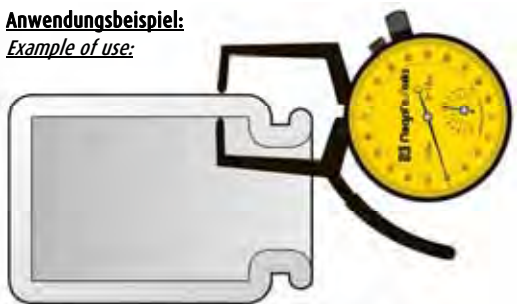

Abmessungen:
Dimensions:

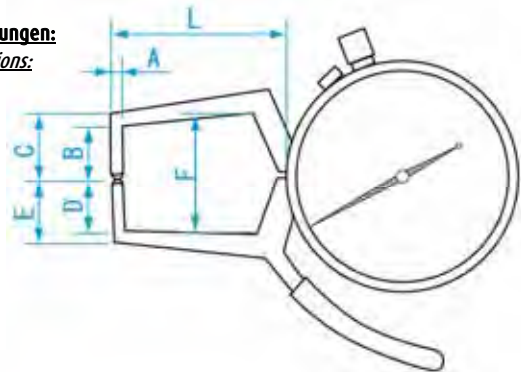

Messuhren Dial gauges

Digital-Innen-Schnellmesstaster *Digital caliper gauge for inside measurements*

Auflösung 0,01 mm | mit Rundspitzen | Anzeige drehbar | Aufbewahrungsbox
Reading 0.01 mm | with rounded contact | display rotatable | box



13-111

Abmessungen:
Dimensions:

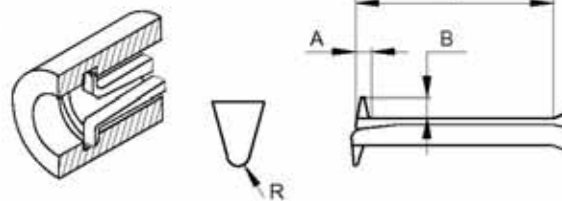

Art.-Nr. Order no.	Messbereich Range	Messtiefe L Depth of frame L	A (mm)	B (mm)	Messspitze R Meas. Tips R	Genauigkeit Accuracy	EUR
13-101	5-15 mm	20 mm	1,0	1,5	R 0,3 mm	0,03 mm	159,00
13-111	5-25 mm	35 mm					182,00
13-112	10-30 mm	55 mm	2,5	3,5	R 0,5 mm	0,04 mm	191,00
13-113	20-40 mm	80 mm	3,0	6,5			198,00
13-114	30-50 mm			8,5			205,00

Digital-Außen-Schnellmesstaster *Digital caliper gauge for outside measurements*

Auflösung 0,01 mm | mit Rundspitzen | Anzeige drehbar | Aufbewahrungsbox
Reading 0.01 mm | with rounded contact | display rotatable | box



13-121

Abmessungen:
Dimensions:

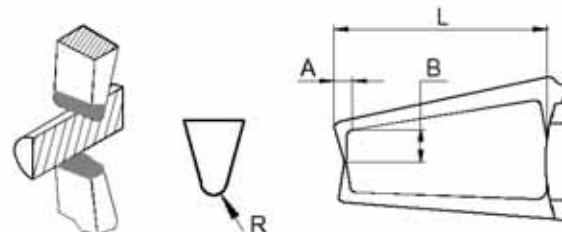

Art.-Nr. Order no.	Messbereich Range	Messtiefe L Depth of frame L	A (mm)	B (mm)	Messspitze R Meas. Tips R	Genauigkeit Accuracy	EUR
13-121	0-10 mm	40 mm	3,0	8	R 0,5 mm	0,03 mm	159,00
13-131	0-20 mm	80 mm	6,5	25	R 0,75 mm	0,04 mm	182,00
13-132	10-30 mm						196,00
13-133	20-40 mm						196,00
13-134	30-50 mm						196,00

KROEPLIN Außen-Schnellmesstaster 0,1 mm *Caliper gauge for outside measurements 0.1 mm*

Messbereich 0-10 mm | Ablesung 0,1 mm | Messtiefe 36 mm | Genauigkeit 0,1 mm
Range 0-10 mm | reading 0.1 mm | depth of frame 36 mm | accuracy 0.1 mm



42-101



42-102

Art.-Nr. Order no.	Messkontakt Measuring tips	EUR
42-101	Ø5x5 mm	104,00
42-102	Ø0,75x3,5 mm	104,00

Kroeplin
 Längenmesstechnik

Messuhren Dial gauges

KROEPLIN Innen-Schnellmesstaster *Caliper gauge for inside measurements*

Schutzklasse IP65
Protection class IP65

Kroeplin
Längenmesstechnik



Art.-Nr. Order no.	Messbereich Range	Messtiefe Depth of frame	Ablesung Reading	Genauigkeit Accuracy	Messkontakt Measuring tips	EUR
42-010	2,5-12,5 mm	12 mm	0,005 mm	0,015 mm	R0,1 mm	369,00
42-011	5-15 mm	35 mm			Ø0,6 mm	369,00
42-012	10-30 mm	85 mm	0,01 mm	0,03 mm	Ø1,0 mm	369,00
42-013	20-40 mm					369,00
42-014	30-50 mm					369,00
42-015	40-60 mm					369,00



Schneide R0,1 mm
blade R0.1 mm

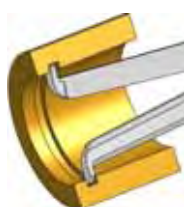

Kugel Ø0,6/Ø1,0 mm
ball Ø0.6/Ø1.0 mm

Holz-Aufbewahrungsbox mit Schaumstoff-Einlage
wooden box with foam inlay



Art.-Nr. Order no.	EUR
42-098	27,90

KROEPLIN Außen-Schnellmesstaster *Caliper gauge for outside measurements*

Schutzklasse IP65
Protection class IP65

Kroeplin
Längenmesstechnik



Art.-Nr. Order no.	Messbereich Range	Messtiefe Depth of frame	Ablesung Reading	Genauigkeit Accuracy	Messkontakt Measuring tips	EUR
42-110	0-10 mm	35 mm	0,005 mm	0,015 mm	Ø1,5 mm	369,00
42-112	0-20 mm	85 mm	0,01 mm	0,03 mm		369,00
42-114	0-50 mm	167 mm	0,05 mm	0,05 mm	Ø3,0 mm	425,00
42-118	50-100 mm			0,075 mm		455,00

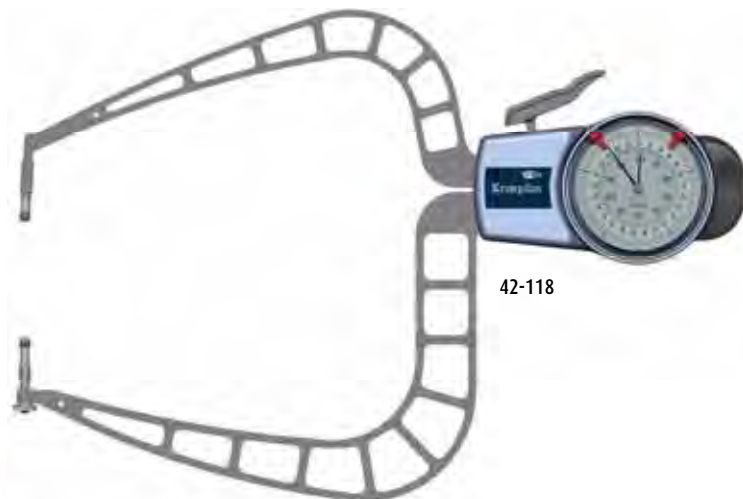

Holz-Aufbewahrungsbox mit Schaumstoff-Einlage (nur bis Messbereich 20 mm)

wooden box with foam inlay (only up to Range 20 mm)



Art.-Nr. Order no.	EUR
42-098	27,90

Messuhren Dial gauges

KROEPLIN Digital-Innen-Schnellmesstaster Digital caliper gauge for inside measurements

wasserdicht (Schutzklasse IP67) | Datenausgang
waterproof (protection class IP67) | data output

Kroeplin
Längenmesstechnik

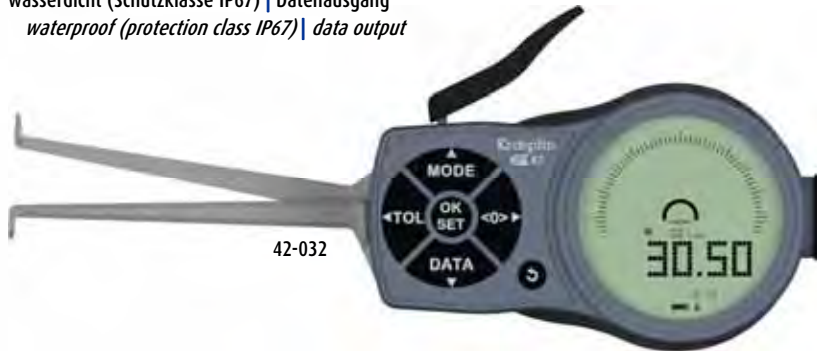

42-032

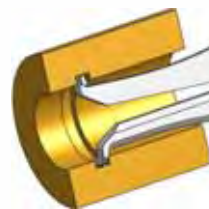
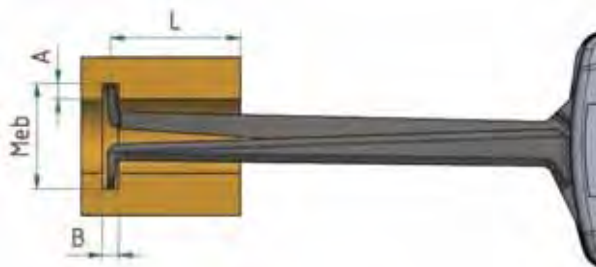

Schneide R0,12 mm
blade R0.12 mm



Kugel Ø0,6/Ø1,0 mm
ball Ø0.6/Ø1.0 mm

Art.-Nr. Order no.	Messbereich Range Meb	Messtiefe Depth of frame L	Auflösung Reading	Genauigkeit Accuracy	Messkontakt Measuring tips	max. Einstichtiefe max. cut-in depth A	min. Nutbreite min. slot width B	EUR
42-030	2,5-12,5 mm	12 mm	0,005 mm	0,015 mm	R0,1 mm	0,7 mm	0,4 mm	379,00
42-031	5-15 mm	35 mm			Ø0,6 mm	2,2 mm	0,8 mm	379,00
42-032	10-30 mm	85 mm	0,01 mm	0,03 mm	Ø1,0 mm	5,0 mm	1,7 mm	379,00
42-033	20-40 mm					6,8 mm		379,00
42-034	30-50 mm					8,3 mm		379,00
42-035	40-60 mm					379,00		

Zubehör:

Accessories:



42-081



42-091*

Art.-Nr. Order no.	Bezeichnung Description	EUR
42-081	Schnittstellenadapter Bluetooth (Sender und USB-Empfänger) Interface adapter Bluetooth (sender and USB-receiver)	95,00
42-091	Halterung mit Aufnahmeschraube Ø8 h8 (zur Aufnahme mit allen gängigen Stativen mit Aufnahmebohrung Ø8 mm) Holder with shaft Ø8 h8 (for fixation with all common measuring stands with bore Ø8 mm)	78,50
42-099	Holz-Aufbewahrungsbox (mit Schaumstoff-Einlage) Wooden box (with foam inlay)	27,90



42-099*

*Lieferung ohne Messgerät
Delivery without measuring device



Messuhren Dial gauges

KROEPLIN Digital-Außen-Schnellmesstaster *Digital caliper gauge for outside measurements*

wasserdicht (Schutzklasse IP67) | Datenausgang (bis Messbereich 20 mm)
waterproof (protection class IP67) | data output (up to range 20 mm)

Kroeplin
Längenmesstechnik



42-130

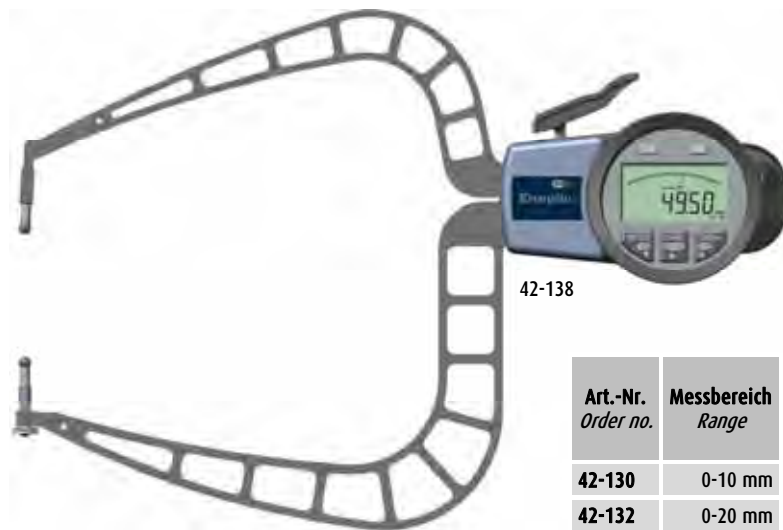

42-138

Art.-Nr. Order no.	Messbereich Range	Messtiefe Depth of frame	Auflösung Reading	Genauigkeit Accuracy	Mess- kontakt Measuring tips	EUR
42-130	0-10 mm	35 mm	0,005 mm	0,015 mm	Ø1,5 mm	379,00
42-132	0-20 mm	85 mm	0,01 mm	0,03 mm		379,00
42-134	0-50 mm	167 mm	0,02 mm	0,06 mm	Ø3,0 mm	525,00
42-138	50-100 mm			0,08 mm		565,00

Zubehör (nur für Modelle bis 20 mm):

Accessories (only for models up to 20 mm):



42-081



42-091*



42-099*

Art.-Nr. Order no.	Bezeichnung Description	EUR
42-081	Schnittstellenadapter Bluetooth (Sender und USB-Empfänger) <i>Interface adapter Bluetooth (sender and USB-receiver)</i>	95,00
42-091	Halterung mit Aufnahmeschaft Ø8 h8 (zur Aufnahme mit allen gängigen Stativen mit Aufnahmebohrung Ø8 mm) <i>Holder with shaft Ø8 h8 (for fixation with all common measuring stands with bore Ø8 mm)</i>	78,50
42-099	Holz-Aufbewahrungsbox (mit Schaumstoff-Einlage) <i>Wooden box (with foam inlay)</i>	27,90

*Lieferung ohne Messgerät
Delivery without measuring device

Messuhren Dial gauges

KROEPLIN Digital-Innen-Schnellmesstaster 1 µm Digital caliper gauge for inside measurements 1 µm

Auflösung 0,001 mm | Genauigkeit 0,01 mm, Wiederholgenauigkeit 0,005 mm | wasserdicht (Schutzklasse IP67)
Reading 0.001 mm | Accuracy 0.01 mm, Repeat accuracy 0.005 mm | waterproof (protection class IP67)

Kroeplin
Längenmesstechnik



42-202

Art.-Nr. Order no.	Messbereich Meb Range Meb	Messtiefe L Depth of frame L	max. Einstichtiefe A max. cut-in depth A	min. Nutbreite B min. slot width B	Messkontakt Measuring tips	EUR
42-201	2,5-12,5 mm	12 mm	0,7 mm	0,6 mm	R0,12 mm	419,00
42-202	5-20 mm	44 mm	2,2 mm	0,8 mm	Ø0,6 mm	419,00
42-203	10-25 mm	46 mm	4 mm	1,5 mm	Ø1,0 mm	419,00

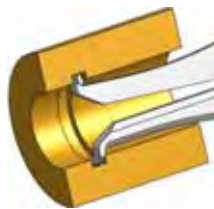

Schneide R0,12 mm
blade R0.12 mm



Kugel Ø0,6/Ø1,0 mm
ball Ø0.6/Ø1.0 mm

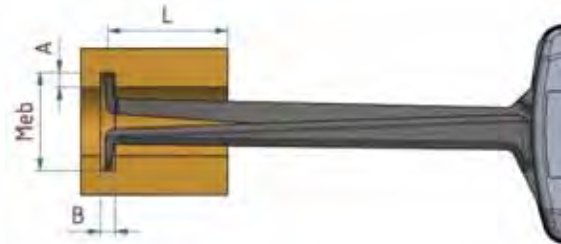

KROEPLIN Digital-Außen-Schnellmesstaster 1 µm Digital caliper gauge for outside measurements 1 µm

Auflösung 0,001 mm | Genauigkeit 0,01 mm (0,015 mm bei 42-212), Wiederholgenauigkeit 0,005 mm | wasserdicht IP67
Reading 0.001 mm | Accuracy 0.01 mm (0.015 mm at 42-212), Repeat accuracy 0.005 mm | waterproof IP67

Kroeplin
Längenmesstechnik



42-211

Art.-Nr. Order no.	Messbereich Meb Range Meb	Messtiefe L Depth of frame L	max. Einstichtiefe A max. cut-in depth A	min. Nutbreite B min. slot width B	Messkontakt Measuring tips	EUR
42-211	0-15 mm	45 mm	15 mm	2,5 mm	Ø1,5 mm	419,00
42-212			11 mm	1,5 mm	R0,4 mm	419,00

KROEPLIN Zubehör für Schnellmesstaster 1 µm Accessories for digital caliper gauges 1 µm

Passend zu den KROEPLIN Digital-Schnellmesstastern 42-201 bis 42-212
Suitable for KROEPLIN digital caliper gauges 42-201 to 42-212

Kroeplin
Längenmesstechnik



42-251

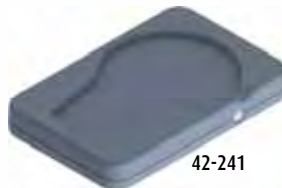

42-241



42-252*



42-257



Art.-Nr. Order no.	Bezeichnung Description	EUR
42-241	Ladestation für kabelloses Laden (inkl. Netzteil) Wireless charging station (incl. power supply)	41,00
42-251	Schnittstellenadapter kabelgebunden Interface adapter tethered	94,50
42-252*	Datenkabel USB data transfer cable USB (2 m)	117,00
42-257	Schnittstellenadapter Bluetooth (Sender+USB-Empfänger) Interface adapter Bluetooth (sender + USB receiver)	95,00
42-298	Holz-Aufbewahrungsbox wooden box	41,00

*nur zusammen mit 42-251 einsetzbar! Einfache Datenübernahme in jedes Windows-Programm
applicable only together with 42-251! Simple data transfer into every Windows program

Messuhren Dial gauges

KROEPLIN Digital-3-Punkt-Innen-Schnellmesstaster *Digital 3-point caliper gauge for inside measurements*

wasserdicht (Schutzklasse IP67)
waterproof (protection class IP67)

Kroeplin
Längenmesstechnik

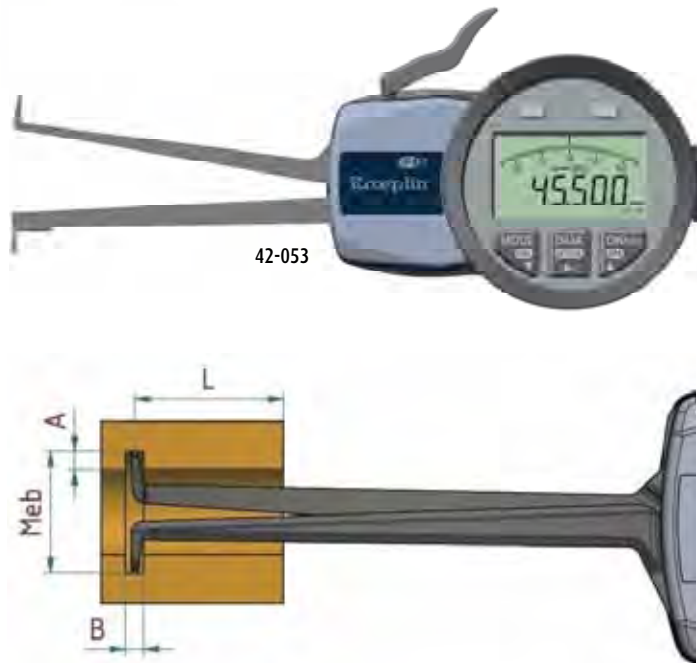

Messkontakt A
Kugel Ø0,6 mm
measuring tip A
ball Ø0.6 mm



Messkontakt B
Kugel Ø1 mm
measuring tip B
ball Ø1 mm



Messkontakt C
Kugel Ø1 mm
measuring tip C
ball Ø1 mm

Art.-Nr. Order no.	Messbereich Meb Range Meb	Messtiefe L depth of frame L	max. Einstichtiefe A max. cut-in depth A	min. Nutbreite B min. slot width B	Auflösung Reading	Genauigkeit Accuracy	Messkontakt Measuring tip	EUR
42-050	Ø7-14 mm	34 mm	2,2 mm	0,8 mm	0,002 mm	0,01 mm	A	458,00
42-051	Ø10-20 mm	75 mm	3,5 mm	1,6 mm	0,005 mm	0,02 mm	B	458,00
42-052	Ø15-30 mm	77 mm	5,0 mm					458,00
42-053	Ø25-45 mm		7,0 mm					458,00
42-054	Ø40-60 mm		8,0 mm					458,00
42-055	Ø55-75 mm	84 mm		1,6 mm	0,005 mm	0,02 mm	C	458,00
42-056	Ø70-90 mm		8,5 mm					458,00
42-057	Ø85-105 mm		9,0 mm					458,00

Holz-Aufbewahrungsbox mit Schaumstoff-Einlage
wooden box with foam inlay

Art.-Nr. Order no.	EUR
42-098	27,90



Weitere KROEPLIN-Schnellmesstaster auf Anfrage!
Further KROEPLIN caliper gauges on request!

Messuhren Dial gauges

HELIOS-PREISSER Außeneinstich-Messgerät *Measuring instrument for outside cut-in*

Ideal für Serienmessungen von Einstichdurchmessern an Drehteilen | schmale Messflächen aus gehärtetem Stahl | hochgenaue Kugelführung des Übertragungsbolzens | runder Auflagetisch höhenverstell- und klemmbar zur exakten Einstellung der Messposition | schwerer Standfuß | Basiseinheit im Winkelraster 0°/30°/60°/90° kipp- und klemmbar | Aufnahme für Messuhren mit Schaft Ø8 mm | Lieferung ohne Messuhr



Ideal for serial measurements of cut-ins at turning parts | narrow measuring tips made from hardened steel | transmission bolt with precision ball guide | round support table height adjustable and clamp function for exact adjustment of measuring position | heavy pedestal | base tiltable (0°/30°/60°/90°) with clamp function | seat for dial gauges with shaft Ø8 mm | without dial gauge



Art.-Nr. Order no.	Messbereich Range	Auflagetisch support table	max. Abstand h max. distance h	EUR
46-571	0-10 mm	Ø25 mm	8 mm	923,00
46-572	0-25 mm	Ø38 mm	13 mm	996,00
46-573	25-50 mm	Ø50 mm	35 mm	1065,00

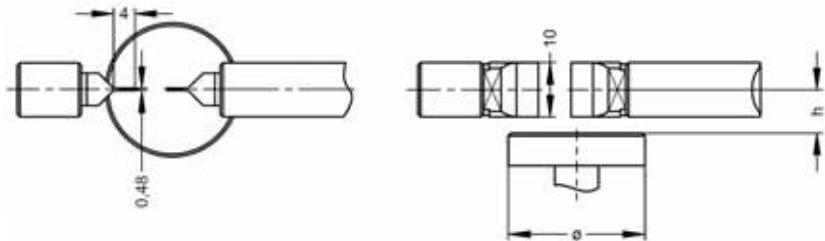

HELIOS-PREISSER Inneneinstich-Messgerät *Measuring instrument for inside cut-in*

Ideal für Serienmessungen von Inneneinstichdurchmessern | hochgenaue Tasterführung mit konstantem Messdruck | Einstellung der Höhe mit Endmaßen | Einstellung des Durchmessers mit Einstellring | Messtischplatte 110x73 mm | Aufnahme für Messuhren mit Schaft Ø8 mm | Lieferung ohne Messtaster, ohne Messuhr, ohne Endmaße, ohne Einstellring



Ideal for serial measurements of inside cut-ins | precision feeler guide with constant measuring force | height adjustment with gauge blocks | diameter adjustment with setting ring | support table 110x73 mm | seat for dial gauges with shaft Ø8 mm | without measuring tips, without dial gauge, without gauge blocks, without setting ring



46-581 mit 46-586



Anwendungsbeispiel
Example of use

Art.-Nr. Order no.	EUR
46-581	898,00

Messtaster (jeweils 1 Paar) *Measuring tips (1 pair in each case)*

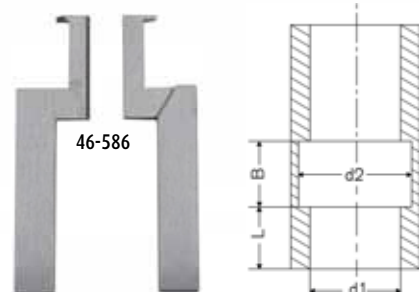

Werkstückabmessungen
Dimensions of workpiece

Art.-Nr. Order no.	d1 (Ø)	d2 (Ø) max.	B min.	L	EUR
46-583	4-28 mm	d1+2 mm	0,74 mm	0-8 mm	89,50
46-584	6,5-30 mm	d1+4 mm	1,0 mm	0-10 mm	89,50
46-585	13-38 mm	d1+2 mm	1,2 mm	0-18 mm	89,50
46-586	20,5-51 mm	d1+4 mm	1,2 mm	0-25 mm	89,50

HELIOS-PREISSER Universal-Vergleichsmessgerät "UHRFAST" Universal comparative measuring instrument

Anwendungsbeispiele:
Examples of use:



Grundgerät Basic device

Vergleichsmessgerät für Außen- und Innenmessungen zum Prüfen von Werkstücken und Einstellen von Maschinen | vielseitig einsetzbar durch große Auswahl an Messtastern und Messeinsätzen (siehe Folgeseite) | Messbereich außen 5-220 mm / innen 15-230 mm / erweiterbar bis zu 2000 mm durch optionale Verlängerungen | Messweg des beweglichen Messarmträgers ca. 18 mm | Messkraft 4 N (innen) / 6 N (außen) - Richtung umschaltbar | Einstellung mittels Einstellgerät, Meisterstück, Endmaßkombinationen, Lehring oder Bügelmessschraube (nicht im Lieferumfang enthalten) | Holzaufbewahrungsbox | Lieferung des Grundgeräts ohne Messuhr, ohne Aufnahmen und ohne Taster

Comparative measuring instrument for outside and inside measurements of work pieces and setting of machines | multi-functional use through large variety of feelers and inserts | measuring range outside 5-220 mm / inside 15-230 mm / extendible up to 2000 mm with optional extension rods | measuring distance of mobile measuring arm approx. 18 mm | measuring force 4 N (inside) / 6 N (outside) - direction switchable | adjustment through adjustment device, master piece, set of gauge blocks, setting ring or micrometer (not included in shipment) | wooden box | shipment of basic device w/o dial gauge, w/o inserts, w/o feelers



Art.-Nr. Order no.	EUR
47-301	1825,00

Messtaster-Aufnahme (Paar) Holding fixture for feeler (pair)

zur Aufnahme der Messtaster Ø5 mm (siehe Folgeseite)
for fixing the feelers Ø5 mm (see following page)

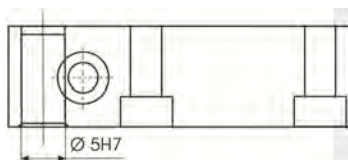

Art.-Nr. Order no.	EUR
47-311	168,00

Messtaster-Aufnahme gewinkelt (Paar) Angled holding fixture for feeler (pair)

zur Aufnahme der Messtaster Ø5 mm (siehe Folgeseite) | umkehrbar zur Innen- und Außenmessung
for fixing the feelers Ø5 mm (see following page) | turnable for inside and outside measurements

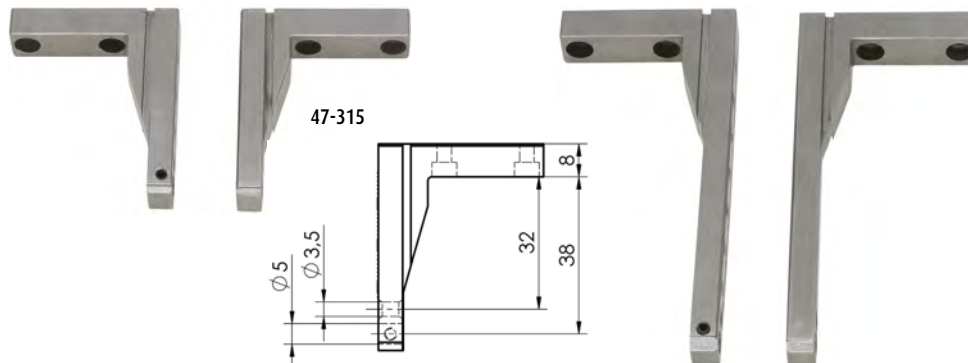

Art.-Nr. Order no.	Länge Length	EUR
47-315	40 mm	265,00
47-316	80 mm	318,00

Tiefenanschlag für gewinkelte Messtaster-Aufnahme (Paar) Depth stop for Angled holding fixture (pair)

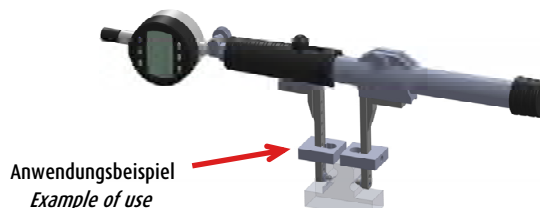
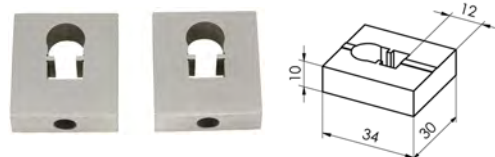

Art.-Nr. Order no.	EUR
47-318	246,00

HELIOS-PREISSER Messtaster für Universal-Vergleichsmessgerät *Feelers for universal comparative measuring instrument*

Messtaster für das Helios-Preisser Universal-Vergleichsmessgerät „UHRTAST“ | Aufnahme Ø5 mm | einsetzbar mit dem Grundgerät 47-301 und einer Messtaster-Aufnahme 47-31... | Lieferung paarweise

Feeler for Helios-Preisser universal comparative measuring instrument | shaft Ø5 mm | applicable with basic device 47-301 and one of holding fixtures 47-31... | shipment in pairs



- kugelig
spherical

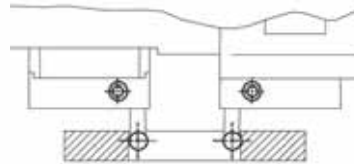
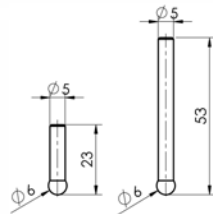

Art.-Nr. Order no.	Länge Length	EUR
47-331	23 mm	113,00
47-332	53 mm	113,00

- zylindrisch
cylindrical

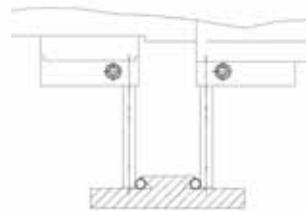
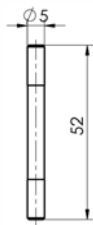

Art.-Nr. Order no.	EUR
47-334	113,00

- gekröpft
angulated

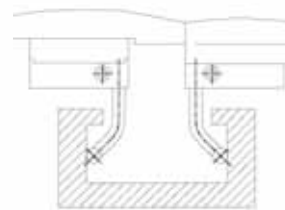
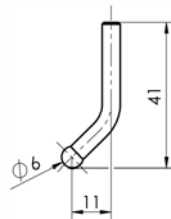

Art.-Nr. Order no.	EUR
47-336	187,00

- Teller
disc

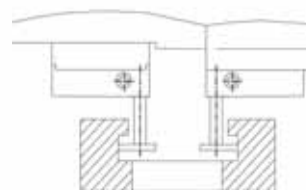
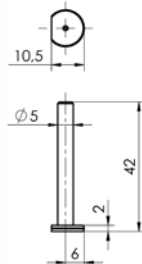

Art.-Nr. Order no.	EUR
47-338	113,00

- Schulter (außen)
Shoulder (outside)

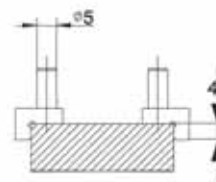
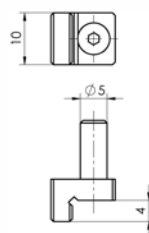

Art.-Nr. Order no.	EUR
47-340	199,00

- Schulter (innen)
Shoulder (inside)

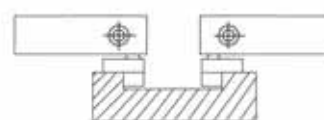
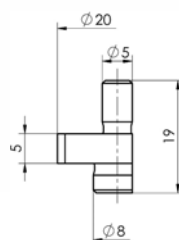

Art.-Nr. Order no.	EUR
47-341	164,00

Messuhren

Dial gauges

HELIOS-PREISSER Zubehör für Universal-Vergleichsmessgerät *Accessories for universal comparative measuring instrument*

Zubehör für das Helios-Preisser Universal-Vergleichsmessgerät „UHRFAST“
Accessories for Helios-Preisser universal comparative measuring instrument



Adapter für Messeinsätze M2,5 (Paar) *Adaptor for inserts with thread M2.5 (pair)*

zur Aufnahme von Messeinsätzen mit Gewinde M2,5 (Standardeinsätze für Messuhren)
seat for inserts with thread M2.5 (standard inserts for dial gauges)



Art.-Nr. Order no.	EUR
47-345	86,50

Verlängerungs-Stücke *Extension rods*

kombinierbar mit Grundgerät und weiteren Verlängerungsstücken
combinable with basic device and further extension rods



Art.-Nr. Order no.	Länge Length	EUR
47-321	100 mm	254,00
47-322	200 mm	269,00
47-323	500 mm	412,00

Messtisch *Measuring table*

Tisch Ø180 mm | inkl. Messtasteraufnahme und Füße
Table Ø180 mm | incl. feeler seat and stand



Art.-Nr. Order no.	EUR
47-398	636,00

Innen-Messgeräte

Internal measuring instruments



Inhalt Contents



04.2



04.3



04.5



04.8



04.12

Normen Standards

Alle unsere Innenmessschrauben nach DIN 863 erfüllen folgende Werte:

All our inside micrometers according to DIN 863 comply with following values:

Messbereich (mm) range (mm)	3-50	50-100	100-150	150-200	200-250	250-300	300-350	350-400	400-450	450-500
Genauigkeit* (µm) Accuracy (µm)	4	5	6	7	8	9	10	11	12	13

*Fehlergrenze G

Weitere Informationen: siehe DIN 863 (DIN Deutsches Institut für Normung e. V., erschienen im Beuth Verlag)
Further information: see DIN 863 (DIN Deutsches Institut für Normung e. V., published by Beuth Verlag)

Kalibrierung Calibration

Informationen zur Kalibrierung erhalten Sie in Kapitel 15!
Information about calibration can be found in chapter 15!

Innen-Messgeräte Internal measuring instruments

Innenmessschraube mit Messschnäbeln *Inside micrometer with jaws*

Ablesung 0,01 mm | Hartmetall-Messflächen bis 100 mm | Ableseile mattverchromt | Box
Reading 0.01 mm | carbide measuring faces (up to 100 mm) | satin chrome finished | box

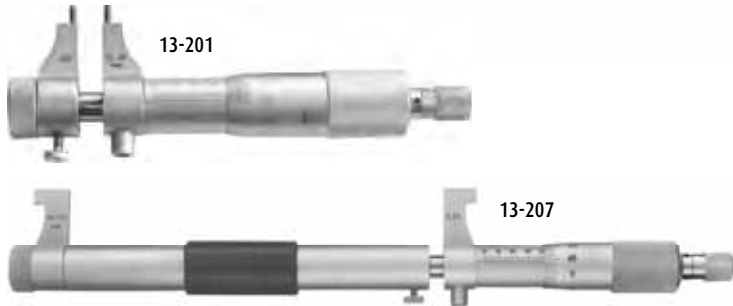

Art.-Nr. Order no.	Messbereich Range	Genauigkeit Accuracy	Einstellmaß setting dim. (mm)	EUR
13-201	5-30 mm	0,01 mm	Ø5	59,50
13-202	25-50 mm		Ø25	68,50
13-203	50-75 mm	0,012 mm	-	79,50
13-204	75-100 mm	0,014 mm	-	92,00
13-205	100-125 mm	0,015 mm	-	99,00
13-206	125-150 mm		-	113,00
13-207	150-175 mm		-	129,00
13-208	175-200 mm		-	141,00
13-209	5-100 mm	0,014 mm	Ø5/Ø25/75	338,00

Innenmessschraube mit doppelseitigen Messschnäbeln *Inside micrometer with double-sided jaws*

Messbereich 5-55 mm | Ablesung 0,01 mm | Genauigkeit 0,01 mm | Ableseile mattverchromt | doppelseitige Messschnäbel mit beidseitiger Teilung | Box
Range 5-55 mm | Reading 0.01 mm | Accuracy 0.01 mm | satin chrome finished | double-sided jaws with both-sided reading | box

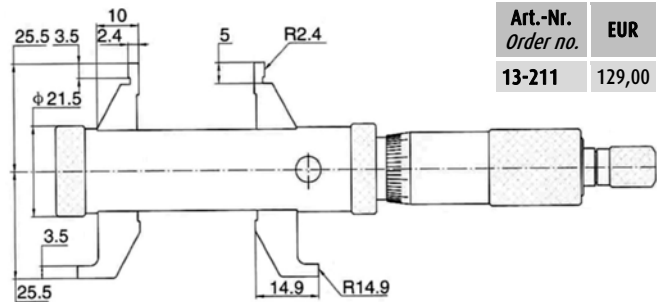

Art.-Nr. Order no.	EUR
13-211	129,00

HELIOS-PREISSER Innenmessschraube mit doppelseitigen Messschnäbeln *Inside micrometer with double-sided jaws*

Messbereich 5-55 mm | Ablesung 0,01 mm | DIN 863 | Hartmetall-Messflächen | Ableseile mattverchromt | doppelseitige Messschnäbel mit beidseitiger Teilung | Made in Germany | Holzbox
Range 5-55 mm | Reading 0.01 mm | DIN 863 | carbide measuring faces | satin chrome finished | double-sided jaws with both-sided reading | Made in Germany | wooden box



Art.-Nr. Order no.	EUR
46-401	865,00

Digital-Innenmessschraube mit Messschnäbeln *Digital inside micrometer with jaws*

Auflösung 0,001 mm / 0,00005 inch | Hartmetall-Messflächen | Aufbewahrungsbox
Reading 0.001 mm / 0.00005 inch | carbide measuring faces | box



Art.-Nr. Order no.	Messbereich Range	Genauigkeit Accuracy	Einstellmaß setting dimension	EUR
13-221	5-30 mm	0,01 mm	Ø5 mm	195,00
13-222	25-50 mm		Ø25 mm	204,00
13-223	50-75 mm		-	212,00
13-224	75-100 mm		-	229,00

Innen-Messgeräte Internal measuring instruments

Quernuten-Messschraube *Groove micrometer*

zum Messen von Innen-Quernuten | Ablesung 0,01 mm | Messbereich außen 0-25 mm, innen 1,6-26,5 mm (Doppel-Skalierung für Innen- und Außenmessung) | Genauigkeit 0,01 mm | Aufbewahrungsbox

for measuring of grooves inside bores | Reading 0.01 mm | Range outside 0-25 mm, inside 1.6-26.5 mm (double scale for inside and outside measuring) | Accuracy 0.01 mm | box



13-301

Art.-Nr. Order no.	D	D1	Gesamtlänge Total length	EUR
13-301	6,5 mm	3 mm	178 mm	258,00
13-302	13 mm	6,35 mm	223 mm	258,00

mögliche Messmethoden: *possible measuring methods:*

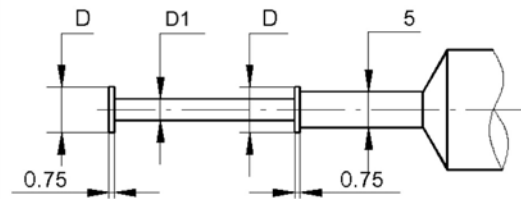
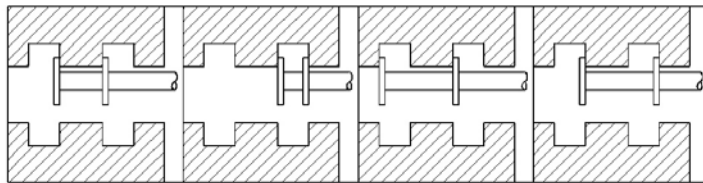

HELIOS-PREISSER Zylindrische Innenmessschraube *Cylindric inside micrometer*

Ablesung 0,01 mm | DIN 863 | Hartmetall-Messflächen | Ableseteile mattverchromt | Made in Germany | Holzbox
Reading 0.01 mm | DIN 863 | carbide measuring faces | satin chrome finished | Made in Germany | wooden box



46-413



46-416

Art.-Nr. Order no.	Messbereich Range	Messtrommel Micrometer drum	Genauigkeit Accuracy	EUR
46-411	25-30 mm	Ø15 mm	0,004 mm	166,00
46-412	30-35 mm			166,00
46-413	35-50 mm			166,00
46-414	50-75 mm	Ø16 mm	0,005 mm	175,00
46-415	75-100 mm	Ø17 mm		181,00
46-416	100-125 mm	Ø20 mm	0,006 mm	203,00
46-417	125-150 mm		208,00	
46-418	150-175 mm		215,00	
46-419	175-200 mm		224,00	
46-420	200-225 mm		229,00	
46-421	225-250 mm		0,008 mm	236,00

Art.-Nr. Order no.	Messbereich Range	Messtrommel Micrometer drum	Genauigkeit Accuracy	EUR
46-422	250-275 mm	Ø20 mm	0,009 mm	244,00
46-423	275-300 mm			254,00
46-424	300-325 mm		0,010 mm	264,00
46-425	325-350 mm			270,00
46-426	350-375 mm		0,011 mm	281,00
46-427	375-400 mm			287,00
46-428	400-425 mm		0,012 mm	298,00
46-429	425-450 mm			308,00
46-430	450-475 mm		0,013 mm	315,00
46-431	475-500 mm			322,00

HELIOS-PREISSER Halter für zylindrische Innenmessschraube *Holder for cylindric inside micrometer*

passend für alle HELIOS-PREISSER Innenmessschrauben 46-411 bis 46-437 | Länge 200 mm | Lieferung ohne Innenmessschraube

suitable for all HELIOS-PREISSER inside micrometers 46-411 to 46-437 | length 200 mm | delivery without inside micrometer



Art.-Nr. Order no.	EUR
46-439	54,00

Innen-Messgeräte Internal measuring instruments

HELIOS-PREISSER Zylindrische Innenmessschraube **zusammensetzbar** *Cylindric inside micrometer modular system*

Ablesung 0,01 mm | DIN 863 | Hartmetall-Messflächen | aufschraubbare Verlängerungsstäbe (Anschlussgewinde M7) |
Ablese­teile mattverchromt | Made in Germany | Holzbox
*Reading 0.01 mm | DIN 863 | carbide measuring faces | extensions provided with thread (connection thread M7) |
satin chrome finished | Made in Germany | wooden box*



46-433

Art.-Nr. Order no.	Messbereich Range	Verlängerungen (mm) Extensions (mm)	Genauigkeit Accuracy	EUR
46-433	50-150 mm	25 / 50	0,006 mm	399,00
46-434	50-250 mm	25 / 50 / 100	0,008 mm	495,00
46-435	50-450 mm	25 / 50 / 100 / 200	0,010 mm	619,00
46-436	50-850 mm	25 / 50 / 100 / 200 / 400	0,012 mm	780,00
46-437	50-1450 mm	25 / 50 / 100 / 200 / 400 / 600	0,015 mm	990,00



46-438-100

Verlängerungsstücke einzeln: *Single extensions:*

Art.-Nr. Order no.	Länge Length	EUR
46-438-025	25 mm	76,50
46-438-050	50 mm	78,50
46-438-100	100 mm	87,00
46-438-200	200 mm	107,00
46-438-400	400 mm	141,00
46-438-600	600 mm	198,00

Zylindrische Innenmessschraube mit verlängertem Messbereich *Cylindric inside micrometer with extended range*

Ablesung 0,01 mm | Hartmetall-Messflächen | Ablese­teile mattverchromt | Genauigkeit $\pm(3 + \text{Anzahl Verlängerungen} + L/50) \mu\text{m}$ | mit Einstellmaß 50 mm
oder 100 mm | Aufbewahrungsbox

Reading 0.01 mm | carbide measuring faces | satin chrome finished | Accuracy $\pm(3 + \text{number of extensions} + L/50) \mu\text{m}$ | with setting dimension 50 mm or 100 mm | box



Grundgerät *basic device*

Art.-Nr. Order no.	Messbereich Range	Verlängerungen (mm) Extensions (mm)	EUR
13-260	50-150 mm	13 / 25 / 50	107,00
13-261	50-250 mm	13 / 25 / 50 / 100	126,00
13-262	50-600 mm	13 / 25 / 50 / 100 / 150 / 200	169,00
13-263	50-1000 mm	13 / 25 / 50 / 2x 100 / 150 / 200 / 300	515,00
13-264	100-1300 mm	25 / 50 / 100 / 200 / 2x 400	748,00
13-265	100-2100 mm	25 / 50 / 100 / 200 / 4x 400	1165,00



13-263

Innen-Messgeräte Internal measuring instruments

Einstellmaß für Innenmessschrauben *Setting dimensions for inside micrometers*

für 2-Punkt-Innenmessschrauben | mattverchromt
for 2-point internal micrometers | satin chrome finished



Art.-Nr. Order no.	Maß dimension	Genauigkeit Accuracy	EUR
13-240	50 mm	0,002 mm	32,50
13-241	75 mm	0,003 mm	45,50
13-242	100 mm		49,50
13-243	150 mm	0,004 mm	76,50
13-244	200 mm		104,00

Präzisions-Innen-Feinmessgerät für kleine Durchmesser *Precision internal measuring instrument for small diameters*

Ablesung 0,01 mm | mit Messuhr | Wiederholgenauigkeit 0,003 mm | Box
Reading 0.01 mm | with dial gauge | Repeat Accuracy 0.003 mm | box



Art.-Nr. Order no.	Messbereich Range	Messtiefe Depth	Genauigkeit Accuracy	EUR
15-101	4-6 mm	42 mm	0,01 mm	398,00
15-102	6-10 mm	50 mm	0,012 mm	169,00



Digital-Präzisions-Innen-Feinmessgerät für kleine Durchmesser *Digital precision internal measuring instrument for small diameters*

Auflösung 0,002 mm | mit Digital-Messuhr | Wiederholgenauigkeit 0,003 mm | Box
Reading 0.002 mm | with digital dial gauge | Repeat Accuracy 0.003 mm | box



Art.-Nr. Order no.	Messbereich Range	Messtiefe Depth	Genauigkeit Accuracy	EUR
15-121	4-6 mm	42 mm	0,01 mm	545,00
15-122	6-10 mm	50 mm	0,012 mm	289,00



Innen-Messgeräte Internal measuring instruments

Innen-Feinmessgerät Internal measuring instrument



Ablesung 0,01 mm | mit Messuhr | Wiederholgenauigkeit 0,01 mm | Box
Reading 0.01 mm | with dial gauge | Repeat Accuracy 0.01 mm | box

Ersatz-Messbolzen und Verlängerungen auf Anfrage!
Spare part measuring tips and extensions on request!



Art.-Nr. Order no.	Messbereich Range	Messtiefe Depth	Kopf Head	EUR
15-001	6-10 mm	50 mm	A	112,00
15-002	10-18 mm	100 mm	B	91,00
15-003	18-35 mm	125 mm	C	88,50
15-004	35-50 mm	150 mm	D	88,50
15-005-1	50-100 mm			78,50
15-005-2	50-160 mm	86,50		
15-006-1	100-250 mm	220 mm		112,00
15-006-2	160-250 mm	400 mm	105,00	
15-007	250-450 mm	320 mm	126,00	

Innen-Feinmessgerät mit verlängertem Messbereich Internal measuring instrument with extended measuring range

Ablesung 0,01 mm | mit Messuhr | Wiederholgenauigkeit 0,01 mm | Aufbewahrungsbox
Reading 0.01 mm | with dial gauge | Repeat Accuracy 0.01 mm | box



Art.-Nr. Order no.	Messbereich Range	Messtiefe Depth	EUR
15-011	35-70 mm	150 mm	98,00
15-012	50-180 mm	150 mm	107,00

Innen-Feinmessgeräte im Satz Internal measuring instrument set

Ablesung 0,01 mm | mit Messuhr | Wiederholgenauigkeit 0,01 mm | Aufbewahrungsbox
Reading 0.01 mm | with dial gauge | Repeat Accuracy 0.01 mm | box



Art.-Nr. Order no.	Messbereich Range	Messuhr dial gauge	EUR
15-016	18-160 mm	analog	222,00
15-018		digital	295,00



Innen-Messgeräte Internal measuring instruments

HELIOS-PREISSER Innenfeinmessgerät 0,95-20,6 mm *Internal measuring instrument 0.95-20.6 mm*

2-Punkt Vergleichsmessgerät mit Spreiztaster und Messnadel | für Messuhren oder Feinzeiger | Aufnahme Ø8 mm | Taster hartmetallbestückt | Made in Germany | Holzetui | Lieferung ohne Messuhr

2-point comparative measurement with expanding mandrel and measuring needle | for dial gauges or indicating calipers | seat hole Ø8 mm | carbide feeler | Made in Germany | wooden box | delivery without dial gauge



Art.-Nr. Order no.	Messbereich Range	Messtiefe Depth	EUR
46-551	0,95-1,55 mm	13 mm	657,00
46-552	1,5-4,2 mm	17-25 mm	936,00
46-553	4,15-7,8 mm	41-45 mm	998,00
46-554	7,7-12,5 mm	45 mm	952,00
46-555	12,2-20,6 mm	45 mm	1099,00

HELIOS-PREISSER Innenfeinmessgerät 18-510 mm *Internal measuring instrument 18-510 mm*

2-Punkt Vergleichsmessgerät durch Umkehrpunktbestimmung | für Messuhren oder Feinzeiger | Aufnahme Ø8 mm | beweglicher Taster hartmetallbestückt | Made in Germany | Holzetui | Lieferung ohne Messuhr

2-point comparative measurement through determination of reversal point | for dial gauges or indicating calipers | seat hole Ø8 mm | movable carbide feeler | Made in Germany | wooden box | delivery without dial gauge



Art.-Nr. Order no.	Messbereich Range	Messtiefe Depth	EUR
46-561	18-35 mm	110 mm	407,00
46-562	35-60 mm	138 mm	395,00
46-563	50-100 mm	177 mm	452,00
46-564	100-160 mm	234 mm	630,00
46-565	160-290 mm	234 mm	910,00
46-566	280-510 mm	400 mm	2160,00

Einstellgerät für Innenfeinmessgerät *Setting gauge for internal measuring instrument*

zum genauen Einstellen von Innenfeinmessgeräten auf das gewünschte Sollmaß mittels Parallelendmaßen | senkrechte Einstellung | Messbacken geläpft | variabler Anschlag | Lieferung ohne Parallelendmaße

for precise setting of internal measuring instruments by use of gauge blocks | vertical use | lapped jaws | variable stopper | delivery without gauge blocks



Art.-Nr. Order no.	Messbereich Range	EUR
15-041	6-35 mm	185,00
15-042	35-300 mm	358,00
15-043	200-500 mm	418,00

Innen-Messgeräte Internal measuring instruments

Innenmessschraube 2-6 mm Internal micrometer 2-6 mm

Ablesung 0,001 mm | Genauigkeit 0,006 mm | Hartmetall-Messflächen | Ableseteile mattverchromt | Box
Reading 0.001 mm | Accuracy 0,006 mm | carbide measuring faces | satin chrome finished | box



13-273

inkl. Einstellring!
incl. setting ring!

Art.-Nr. Order no.	Messbereich Range	Einstellring setting ring	EUR
13-269	2-2,5 mm	Ø2,5 mm	418,00
13-270	2,5-3 mm	Ø2,5 mm	418,00
13-271	3-4 mm	Ø4 mm	345,00
13-272	4-5 mm	Ø5 mm	345,00
13-273	5-6 mm	Ø6 mm	345,00

3-Punkt-Innenmessschraube 6-100 mm 3-point internal micrometer 6-100 mm

Ablesung 0,001 mm (bis 12 mm), 0,005 mm (ab 12 mm) | Hartmetall-Messflächen (ab 12 mm) | Ableseteile mattverchromt | Box | einzeln oder im Satz | inkl. Verlängerung und Einstellring **Hinweis:** Messflächen müssen auf der gesamten Länge anliegen!
Reading 0.001 mm (up to 12 mm), 0.005 mm (from 12 mm) | carbide measuring faces (from 12 mm) | satin chrome finished | box | single or in set | incl. extension and setting ring **Attention:** Ensure full contact at the measuring faces!



14-041



14-204

Art.-Nr. Order no.	Messbereich Range	Messtiefe Depth	Genauigkeit Accuracy	EUR
14-011	6-8 mm	55 mm	0,005 mm	239,00
14-012	8-10 mm			239,00
14-013	10-12 mm			239,00
14-021	12-16 mm	81 mm	0,006 mm	184,00
14-022	16-20 mm			184,00
14-031	20-25 mm	91 mm	0,006 mm	242,00
14-032	25-30 mm			242,00
14-033	30-40 mm	101 mm	0,006 mm	266,00
14-041	40-50 mm			318,00
14-042	50-63 mm			333,00
14-043	62-75 mm	115 mm	0,006 mm	342,00
14-044	75-88 mm			349,00
14-046	87-100 mm			371,00
14-202*	6-12 mm	55 mm	0,005 mm	667,00
14-203*	12-20 mm	81 mm	0,006 mm	369,00
14-204*	20-50 mm	91/101 mm	0,006 mm	886,00
14-205*	50-100 mm	115 mm	0,006 mm	1114,00

*Satz, bestehend aus den obigen Einzel-Messschrauben
Set, consisting of the above single-micrometers

3-Punkt-Innenmessschraube 100-350 mm 3-point internal micrometer 100-350 mm

Ablesung 0,005 mm | Messtiefe 140 mm | Hartmetall-Messflächen | Ableseteile mattverchromt | Box | für Durchgangsbohrungen oder Sacklochbohrungen | ohne Einstellring **Hinweis:** Messflächen müssen auf der gesamten Länge anliegen!
Reading 0.005 mm | Depth 140 mm | carbide measuring faces | satin chrome finished | box | for through holes or blind holes | without setting ring **Attention:** Ensure full contact at the measuring faces!



14-066

für Durchgangsbohrungen for through holes			
Art.-Nr. Order no.	Messbereich Range	Genauigkeit Accuracy	EUR
14-051	100-125 mm	0,006 mm	485,00
14-052	125-150 mm		485,00
14-053	150-175 mm	0,007 mm	498,00
14-054	175-200 mm		512,00
14-055	200-225 mm	0,008 mm	658,00
14-056	225-250 mm		665,00
14-057	250-275 mm	0,009 mm	824,00
14-058	275-300 mm		824,00
14-059	300-325 mm	0,012 mm	1255,00
14-060	325-350 mm		1395,00

14-051 bis to 14-060



für Sacklochbohrungen for blind holes			
Art.-Nr. Order no.	Messbereich Range	Genauigkeit Accuracy	EUR
14-061	100-125 mm	0,006 mm	549,00
14-062	125-150 mm		549,00
14-063	150-175 mm	0,007 mm	638,00
14-064	175-200 mm		638,00
14-065	200-225 mm	0,008 mm	845,00
14-066	225-250 mm		845,00
14-067	250-275 mm	0,009 mm	1025,00
14-068	275-300 mm		1025,00
14-069	300-325 mm	0,012 mm	1485,00
14-070	325-350 mm		1650,00

14-061 bis to 14-070



Innen-Messgeräte Internal measuring instruments

Digitale 3-Punkt-Innenmessschraube 6-100 mm *Digital 3-point internal micrometer 6-100 mm*

Auflösung 0,001 mm | Hartmetall-Messflächen | Aufbewahrungsbox | inkl. Verlängerung und Einstellring

Hinweis: Messflächen müssen auf der gesamten Länge anliegen!

Reading 0.001 mm | carbide measuring faces | box | incl. extension and setting ring

Attention: Ensure full contact at the measuring faces!



Art.-Nr. Order no.	Messbereich Range	Messtiefe Depth	Genauigkeit Accuracy	EUR
14-501	6-8 mm	55 mm	0,005 mm	378,00
14-502	8-10 mm			378,00
14-503	10-12 mm			378,00
14-504	12-16 mm	81 mm	0,006 mm	369,00
14-505	16-20 mm			369,00
14-506	20-25 mm	91 mm	0,006 mm	404,00
14-507	25-30 mm			404,00
14-508	30-40 mm	101 mm	0,006 mm	445,00
14-509	40-50 mm			445,00
14-510	50-63 mm	115 mm	0,006 mm	477,00
14-511	62-75 mm			518,00
14-512	75-88 mm			541,00
14-513	87-100 mm			562,00

Digitale 3-Punkt-Innenmessschrauben im Satz *Digital 3-point internal micrometer set*

techn. Details: siehe oben | Aufbewahrungsbox

technical details: see above | box



Art.-Nr. Order no.	Messbereich Range	Einstellring setting ring	Verlängerung extension	EUR
14-551	6-12 mm	Ø6/Ø8/Ø10 mm	100 mm	1078,00
14-552	12-20 mm	Ø16 mm	150 mm	698,00
14-553	20-50 mm	Ø25/Ø40 mm		1395,00
14-554	50-100 mm	Ø62/Ø87 mm		1711,00

Digitale 3-Punkt-Innenmessschraube 100-350 mm *Digital 3-point internal micrometer 100-350 mm*

Auflösung 0,001 mm | Messtiefe 140 mm | Hartmetall-Messflächen | Box | ohne Einstellring **Hinweis:** Messflächen müssen auf der gesamten Länge anliegen!

Reading 0.001 mm | Depth 140 mm | carbide measuring faces | box | without setting ring **Attention:** Ensure full contact at the measuring faces!



für Durchgangsbohrungen <i>for through holes</i>				für Sacklochbohrungen <i>for blind holes</i>			
Art.-Nr. Order no.	Messbereich Range	Genauigkeit Accuracy	EUR	Art.-Nr. Order no.	Messbereich Range	Genauigkeit Accuracy	EUR
14-580	100-125 mm	0,006 mm	695,00	14-590	100-125 mm	0,006 mm	778,00
14-581	125-150 mm		695,00	14-591	125-150 mm		778,00
14-582	150-175 mm	0,007 mm	739,00	14-592	150-175 mm	0,007 mm	859,00
14-583	175-200 mm		739,00	14-593	175-200 mm		859,00
14-584	200-225 mm	0,008 mm	985,00	14-594	200-225 mm	0,008 mm	1075,00
14-585	225-250 mm		985,00	14-595	225-250 mm		1075,00
14-586	250-275 mm	0,009 mm	1175,00	14-596	250-275 mm	0,009 mm	1260,00
14-587	275-300 mm		1175,00	14-597	275-300 mm		1260,00
14-588	300-325 mm	0,012 mm	1425,00	14-598	300-325 mm	0,012 mm	1690,00
14-589	325-350 mm		1570,00	14-599	325-350 mm		1690,00

14-580 bis to 14-589



14-590 bis to 14-599



Innen-Messgeräte Internal measuring instruments

HELIOS-PREISSER 3-Punkt-Innenmessschraube 3-point internal micrometer

Ablesung 0,001 mm (bis Messbereich 20 mm) / 0,005 mm (ab Messbereich 20 mm) | DIN 863 | Hartmetall-Messflächen (ab Messbereich 12 mm) | für Durchgangsbohrungen (bis Messbereich 12 mm) / für Durchgang- und Sacklochbohrungen (ab Messbereich 12 mm) | einzeln oder im Satz | Kunststofftui | inkl. Einstellring(e) | inkl. Hersteller-Kalibrierzertifikat (für Messgerät und Einstellring)

Reading 0.001 mm (range up to 20 mm) / 0.005 mm (range from 20 mm) | DIN 863 | carbide measuring faces (range from 12 mm) | for through holes (range up to 12 mm) / for through and blind holes (range from 12 mm) | individual or set | box | incl. setting ring(s) | incl. manufacturers calibration certificate (for measuring tool and setting ring)

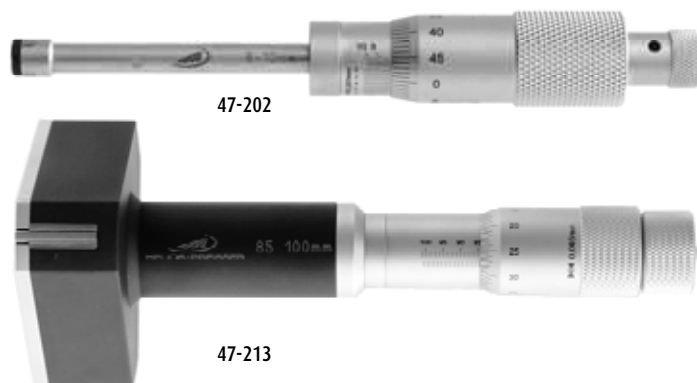

Art.-Nr. Order no.	Messbereich Range	Messtiefe Depth	Genauigkeit Accuracy	EUR
47-201	6-8 mm	58 mm	0,004 mm	389,00
47-202	8-10 mm			389,00
47-203	10-12 mm			389,00
47-204	12-16 mm	64 mm	0,004 mm	389,00
47-205	16-20 mm			414,00
47-206	20-25 mm	68 mm	0,004 mm	425,00
47-207	25-30 mm			431,00
47-208	30-40 mm	76 mm	0,004 mm	483,00
47-209	40-50 mm			483,00
47-210	50-60 mm	79 mm	0,005 mm	557,00
47-211	60-70 mm			573,00
47-212	70-85 mm	97 mm	0,005 mm	589,00
47-213	85-100 mm			605,00
47-214	100-125 mm	132 mm	0,006 mm	849,00
47-215	125-150 mm			999,00
47-216	150-175 mm		0,007 mm	1055,00
47-217	175-200 mm	1115,00		
47-221*	6-12 mm	58 mm	0,004 mm	1095,00
47-222*	12-20 mm	64 mm		775,00
47-223*	20-50 mm	68/76 mm	0,005 mm	1895,00
47-224*	50-100 mm	79/97 mm		2275,00

*Satz, bestehend aus den obigen Einzel-Messschrauben
Set, consisting of the above single-micrometers

HELIOS-PREISSER Messtiefenverlängerung für 3-Punkt-Innenmessschrauben

Rod for depth extension of 3-point internal micrometer

für alle aktuellen analogen und digitalen HELIOS-PREISSER 3-Punkt-Innenmessschrauben und 3-Punkt-Innenmesspistolen

for all current analog and digital HELIOS-PREISSER 3-point internal micrometers and 3-point internal measuring pistols



Art.-Nr. Order no.	für Messbereich for range	Länge Length	EUR
47-231	6-12 mm	75 mm	89,50
47-232	12-20 mm		96,00
47-233	20-30 mm	150 mm	99,50
47-234	30-200 mm		122,00

Innen-Messgeräte Internal measuring instruments

HELIOS-PREISSER Digitale 3-Punkt-Innenmessschraube mit Datenausgang *Digital 3-point internal micrometer with data output*

Auflösung 0,001 mm / 0,00005 inch | DIN 863 | Hartmetall-Messflächen (ab Messbereich 12 mm) | für Durchgangsbohrungen (bis Messbereich 12 mm) / für Durchgang- und Sacklochbohrungen (ab Messbereich 12 mm) | variabler Datenausgang RS232 / Digimatic / USB | Messköpfe austauschbar | Kunststoffetui | inkl. Einstellring | inkl. Hersteller-Kalibrierzertifikat (für Messgerät und Einstellring)

Reading 0.001 mm / 0.00005 inch | DIN 863 | carbide measuring faces (range from 12 mm) | for through holes (range up to 12 mm) / for through and blind holes (range from 12 mm) | variable data output RS232 / Digimatic / USB | changeable measuring heads | box | incl. setting ring | incl. manufacturers calibration certificate (for measuring tool and setting ring)



Art.-Nr. Order no.	Messbereich Range	Messtiefe Depth	Genauigkeit Accuracy	EUR
47-241	6-8 mm	58 mm	0,004 mm	1075,00
47-242	8-10 mm			1075,00
47-243	10-12 mm			1085,00
47-244	12-16 mm	64 mm	0,004 mm	1085,00
47-245	16-20 mm			1135,00
47-246	20-25 mm	68 mm	0,004 mm	1155,00
47-247	25-30 mm			1165,00
47-248	30-40 mm	76 mm	0,005 mm	1215,00
47-249	40-50 mm			1220,00
47-250	50-60 mm	79 mm	0,005 mm	1310,00
47-251	60-70 mm			1345,00
47-252	70-85 mm	97 mm	0,005 mm	1370,00
47-253	85-100 mm			1425,00
47-254	100-125 mm	132 mm	0,006 mm	1730,00
47-255	125-150 mm			1935,00
47-256	150-175 mm			2080,00
47-257	175-200 mm		0,007 mm	2260,00

Informationen und Zubehör zum Thema Datenübertragung finden Sie in Kapitel 15!
Information and accessories related to data transfer can be found in chapter 15!

HELIOS-PREISSER Digitale 3-Punkt-Innenmessschrauben im Satz *Digital 3-point internal micrometer set*

Auflösung 0,001 mm / 0,00005 inch | DIN 863 | Hartmetall-Messflächen (ab Messbereich 12 mm) | für Durchgangsbohrungen (bis Messbereich 12 mm) / für Durchgang- und Sacklochbohrungen (ab Messbereich 12 mm) | variabler Datenausgang RS232 / Digimatic / USB | jeweils 1 Grundgerät mit wechselbaren Messköpfen | Kunststoffetui | inkl. Einstellring(e) | inkl. Hersteller-Kalibrierzertifikat (für Messgerät und Einstellring)

Reading 0.001 mm / 0.00005 inch | DIN 863 | carbide measuring faces (range from 12 mm) | for through holes (range up to 12 mm) / for through and blind holes (range from 12 mm) | variable data output RS232 / Digimatic / USB | each with 1 base device and changeable measuring heads | box | incl. setting ring(s) | incl. manufacturers calibration certificate (for measuring tool and setting ring)



Art.-Nr. Order no.	Messbereich Range	Messtiefe Depth	Genauigkeit Accuracy	EUR
47-261	6-12 mm	58 mm	0,004 mm	1735,00
47-262	12-20 mm	64 mm		1528,00
47-263	20-50 mm	68/76 mm	0,005 mm	2245,00
47-264	50-100 mm	79/97 mm		2750,00

Informationen und Zubehör zum Thema Datenübertragung finden Sie in Kapitel 15!
Information and accessories related to data transfer can be found in chapter 15!

Innen-Messgeräte

Internal measuring instruments

HELIOS-PREISSER 3-Punkt-Innenmessgerät Baukastensystem 3-point internal micrometer modular design

Baukastensystem aus verschiedenen Grundgeräten und Messköpfen | Hartmetall-Messflächen (ab Messbereich 12 mm) | für Durchgangsbohrungen (bis Messbereich 12 mm) / für Durchgang- und Sacklochbohrungen (ab Messbereich 12 mm)
 Modular design with different base devices and measuring heads | carbide measuring faces (range from 12 mm) | for through holes (range up to 12 mm) / for through and blind holes (range from 12 mm)



Messtiefenverlängerung (optional)
Rod for depth extension (optional)

Art.-Nr. Order no.	für Messbereich for range	Länge Length	EUR
47-231	6-12 mm	75 mm	89,50
47-232	12-20 mm		96,00
47-233	20-30 mm	150 mm	99,50
47-234	30-200 mm		122,00

Grundgerät mit Digitalanzeige*
*base device with digital display**

Art.-Nr. Order no.	Messbereich Range	EUR
47-291	6-20 mm	778,00
47-292	20-100 mm	778,00
47-293	100-200 mm	778,00

*inkl. variablem Datenausgang
 *incl. variable data output
 RS232 / Digimatic / USB



Messköpfe measuring heads

Art.-Nr. Order no.	Messbereich Range	Messtiefe Depth	EUR
47-271	6-8 mm	58 mm	295,00
47-272	8-10 mm		295,00
47-273	10-12 mm		295,00
47-274	12-16 mm	64 mm	295,00
47-275	16-20 mm		312,00
47-276	20-25 mm	68 mm	322,00
47-277	25-30 mm		333,00
47-278	30-40 mm	76 mm	375,00
47-279	40-50 mm		375,00
47-280	50-60 mm	79 mm	445,00
47-281	60-70 mm		455,00
47-282	70-85 mm	97 mm	469,00
47-283	85-100 mm		485,00
47-284	100-125 mm	132 mm	709,00
47-285	125-150 mm		885,00
47-286	150-175 mm		935,00
47-287	175-200 mm		965,00



Grundgerät mit Pistolengriff
base device with pistol grip

Art.-Nr. Order no.	Messbereich Range	EUR
47-295**	6-100 mm	489,00
47-297	100-200 mm	569,00

**inkl. Aufbewahrungskoffer
 **incl. save-keeping case



Messuhr
dial gauge
 siehe Kapitel 03!
 look at chapter 03!



Anwendungsbeispiel
Example of use

Innen-Messgeräte

Internal measuring instruments

KROEPLIN Digital-3-Punkt-Innen-Schnellmesstaster *Digital 3-point caliper gauge for inside measurements*

Schutzklasse IP67
Protection class IP67

Kroeplin
Längenmesstechnik

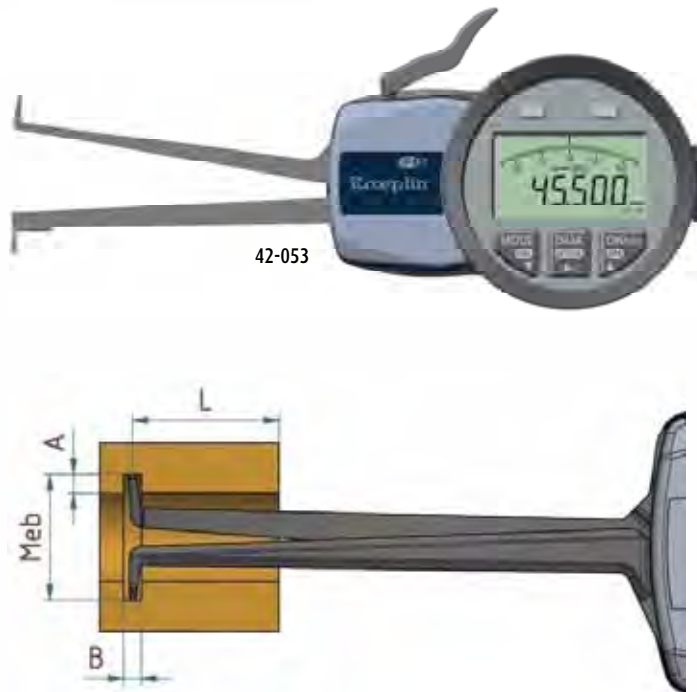

42-053



Messkontakt A
Kugel Ø0,6 mm
measuring tip A
ball Ø0.6 mm



Messkontakt B
Kugel Ø1 mm
measuring tip B
ball Ø1 mm



Messkontakt C
Kugel Ø1 mm
measuring tip C
ball Ø1 mm

Art.-Nr. Order no.	Messbereich Meb Range Meb	Messtiefe L depth of frame L	max. Einstichtiefe A max. cut-in depth A	min. Nutbreite B min. slot width B	Auflösung Reading	Genauigkeit Accuracy	Messkontakt Measuring tip	EUR
42-050	Ø7-14 mm	34 mm	2,2 mm	0,8 mm	0,002 mm	0,01 mm	A	458,00
42-051	Ø10-20 mm	75 mm	3,5 mm	1,6 mm	0,005 mm	0,02 mm	B	458,00
42-052	Ø15-30 mm	77 mm	5,0 mm					458,00
42-053	Ø25-45 mm		7,0 mm					458,00
42-054	Ø40-60 mm		8,0 mm	1,6 mm	0,005 mm	0,02 mm	C	458,00
42-055	Ø55-75 mm	84 mm						458,00
42-056	Ø70-90 mm		8,5 mm					458,00
42-057	Ø85-105 mm		9,0 mm					458,00

Holz-Aufbewahrungsbox mit Schaumstoff-Einlage
wooden box with foam inlay

Art.-Nr. Order no.	EUR
42-098	27,90



01



02



03



04



05



06



07



08



09



10



11



12



13



14



15



Anreißwerkzeuge, Lineale

Marking gauges, rulers



Inhalt Contents



05.2



05.6



05.7



05.8



05.9



05.11

Normen Standards

Alle unsere Maßstäbe nach EG-Klasse II erfüllen folgende Werte:

All our rulers according to EG class II comply with following values:

Länge (mm) length (mm)	500	1000	1500	2000	3000	4000	5000	10000	20000	50000
Genauigkeit* (mm) Accuracy* (mm)	±0,4	±0,5	±0,6	±0,7	±0,9	±1,1	±1,3	±2,3	±4,3	±10,3

*zulässige Toleranz *permitted tolerance*

Alle unsere Präzisionslineale/Arbeitsmaßstäbe nach DIN 866 erfüllen folgende Werte:

All our precision rulers according to DIN 866 comply with following values:

Länge (mm) Length (mm)	500	1000	1500	2000	3000	4000	5000
Genauigkeit* bei Form A (mm) Accuracy type A (mm)	±0,04	±0,04	±0,06	±0,06	±0,08	±0,10	±0,12
Genauigkeit* bei Form B (mm) Accuracy type B (mm)	±0,10	±0,10	±0,15	±0,15	±0,20	±0,25	±0,30

*Fehlergrenze

Weitere Informationen: siehe DIN 866 (DIN Deutsches Institut für Normung e. V., erschienen im Beuth Verlag)

Further information: see DIN 866 (DIN Deutsches Institut für Normung e. V., published by Beuth Verlag)

Kalibrierung Calibration

Informationen zur Kalibrierung erhalten Sie in Kapitel 15!

Information about calibration can be found in chapter 15!

Anreißwerkzeuge, Lineale Marking gauges, rulers

Höhenreißer *Height gauge*



Ablesung 0,05 mm | Hartmetall-Anreißnadel | Ableseile mattverchromt | DIN 862
Reading 0.05 mm | carbide scriber | satin chrome finished | DIN 862

Art.-Nr. Order no.	Messbereich Range	Genauigkeit Accuracy	EUR
16-001	0-300 mm	0,05 mm	62,50
16-002	0-500 mm	0,07 mm	118,00

Ersatz-Anreißnadeln *spare part scriber*



Art.-Nr. Order no.	für Messbereich for range	Aufnahme seat	Abmessungen (BxH/H1/L) dimensions (BxH/H1/L)	EUR
16-009	0-300 mm	2x M5	9,6x8/15/67 mm	18,50
16-007	0-500 mm	10x12 mm	10x12/18/100 mm	18,50

Anreißnadeln für ältere/andere Modelle: siehe Folgeseiten!
Spare part scribers for older/different models: see following pages!

Höhenreißer mit Lupe *Height gauge with loupe*

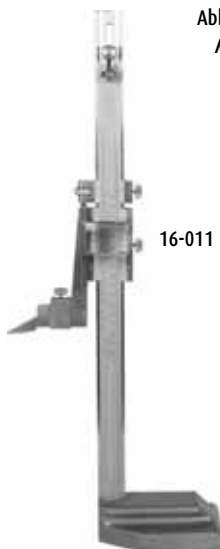

Ablesung 0,05 mm | Hartmetall-Anreißnadel | Ableseile mattverchromt | Messstange verstellbar | DIN 862
Reading 0.05 mm | carbide scriber | satin chrome finished | scale adjustable | DIN 862

Art.-Nr. Order no.	Messbereich Range	Genauigkeit Accuracy	EUR
16-011	0-300 mm	0,05 mm	99,00
16-013	0-600 mm	0,07 mm	218,00

Ersatz-Anreißnadeln *spare part scriber*



Art.-Nr. Order no.	für Messbereich for range	Aufnahme seat	Abmessungen (BxH/H1/L) dimensions (BxH/H1/L)	EUR
16-016	0-300 mm	8,3x11 mm	8,3x11/17/80 mm	18,50
16-017	0-600 mm	11x14 mm	11x14/18,3/98 mm	18,50

Anreißnadeln für ältere/andere Modelle: siehe Folgeseiten!
Spare part scribers for older/different models: see following pages!

Höhenmess- und Anreißgerät *Height and marking gauge*



Ablesung 0,01 mm | Hartmetall-Anreißnadel | mit Zählwerk und Messuhr | Verstellung über Handrad
Reading 0.01 mm | carbide scriber | with counter and dial gauge | adjustable via hand wheel

Art.-Nr. Order no.	Messbereich Range	Genauigkeit Accuracy	EUR
16-021	0-300 mm	0,03 mm	198,00
16-023	0-600 mm	0,05 mm	390,00

Ersatz-Anreißnadeln *spare part scriber*



Art.-Nr. Order no.	Aufnahme seat	Abmessungen (BxH/H1/L) dimensions (BxH/H1/L)	EUR
16-026	9x9 mm	8,5x9/15,3/78 mm	21,00

Messuhren-Halter (Länge 100 mm, Aufnahmen: Ø4/Ø8 mm / Schwalbenschwanznut):
holder for dial gauge (length 100 mm, seats: Ø4/Ø8 mm / dove tail groove):



Art.-Nr. Order no.	Aufnahme seat	EUR
16-561	9x9 mm	14,50

Anreißwerkzeuge, Lineale

Marking gauges, rulers

Digitaler Höhenreißer *Digital height gauge*

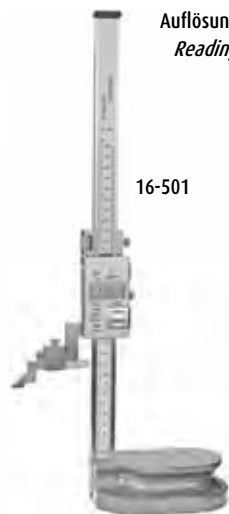

Auflösung 0,01 mm / 0,0005 inch | Hartmetall-Anreißnadel | Datenausgang RB5
 Reading 0.01 mm / 0.0005 inch | carbide scriber | data output RB5

Art.-Nr. Order no.	Messbereich Range	Genauigkeit Accuracy	EUR
16-501	0-300 mm	0,03 mm	178,00
16-502	0-500 mm	0,05 mm	257,00
16-503	0-1000 mm	0,07 mm	715,00

Ersatz-Anreißnadeln *spare part scriber*

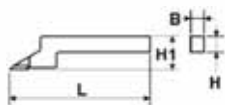

Art.-Nr. Order no.	für Messbereich for range	Aufnahme seat	Abmessungen (BxH/H1/L) dimensions (BxH/H1/L)	EUR
16-506	0-300 mm	6x8 mm	6x8/25,4/75 mm	21,00
16-507	0-500 mm	10x12 mm	10x12/25/101 mm	21,00
16-508	0-1000 mm	10x15 mm	10x15/37/110 mm	21,00

Anreißnadeln für ältere/andere Modelle: siehe Folgeseiten!
 Spare part scribers for older/different models: see following pages!

Digitales Höhenmess- und Anreißgerät mit Handrad-Verstellung *Digital height and marking gauge with hand wheel*



Auflösung 0,01 mm / 0,0005 inch | Hartmetall-Anreißnadel
 Reading 0.01 mm / 0.0005 inch | carbide scriber

Art.-Nr. Order no.	Messbereich Range	Genauigkeit Accuracy	EUR
16-521	0-300 mm	0,03 mm	224,00
16-522	0-600 mm	0,05 mm	328,00

Ersatz-Anreißnadeln *spare part scriber*



Art.-Nr. Order no.	Aufnahme seat	Abmessungen (BxH/H1/L) dimensions (BxH/H1/L)	EUR
16-527	10x12 mm	10x12/41/110 mm	21,00

Messuhren-Halter (Länge 100 mm, Aufnahmen Ø4/Ø8 mm / Schwalbenschwanznut):
 holder for dial gauge (length 100 mm, seats Ø4/Ø8 mm / dove tail groove):



Art.-Nr. Order no.	Aufnahme seat	EUR
16-562	9x11 mm	19,50

Digitales Höhenmess- und Anreißgerät mit Doppelsäule *Digital height and marking gauge with double column*



Auflösung 0,01 mm / 0,0005 inch | Hartmetall-Anreißnadel | Handrad-Verstellung
 Reading 0.01 mm / 0.0005 inch | carbide scriber | adjustable via hand wheel

Art.-Nr. Order no.	Messbereich Range	Genauigkeit Accuracy	EUR
16-511	0-300 mm	0,03 mm	329,00
16-513	0-600 mm	0,05 mm	585,00

Ersatz-Anreißnadeln *spare part scriber*



Art.-Nr. Order no.	Aufnahme seat	Abmessungen (BxH/H1/L) dimensions (BxH/H1/L)	EUR
16-026	9x9 mm	8,5x9/15,3/78 mm	21,00

Messuhren-Halter (Länge 100 mm, Aufnahmen: Ø4/Ø8 mm / Schwalbenschwanznut):
 holder for dial gauge (length 100 mm, seats Ø4/Ø8 mm / dove tail groove):



Art.-Nr. Order no.	Aufnahme seat	EUR
16-561	9x9 mm	14,50

Anreißwerkzeuge, Lineale Marking gauges, rulers

Ersatz-Anreißnadeln für Höhenreißer *Spare part scribers for height gauges*

Hartmetall bestückt | für aktuelle und ältere Modelle
carbide tipped | for current and older models



16-026



Art.-Nr. Order no.	Aufnahme seat	BxH (mm)	H1 (mm)	L (mm)	EUR
16-007	10x12 mm	10x12	18	100	18,50
16-008	2x M5	11x14	14,7	80	18,50
16-009	2x M5	9,6x8	15	67	18,50
16-016	8,3x11 mm	8,3x11	17	80	18,50
16-017	11x14 mm	11x14	18,3	98	18,50
16-018	9x9 mm	9x9	40	80	18,50
16-026	9x9 mm	8,5x9	15,3	78	21,00
16-506	6x8 mm	6x8	25,4	75	21,00
16-507	10x12 mm	10x12	25	101	21,00
16-508	10x15 mm	10x15	37	110	21,00
16-516	9x11 mm	8,5x11	18	79	21,00
16-527	10x12 mm	10x12	41	110	21,00

Weitere Ersatz-Anreißnadeln auf Anfrage!
Further spare part scribers on request!

HELIOS-PREISSER Höhenreißer *Height gauge*

analog oder digital | Ableseerteile mattverchromt (analog) | parallaxfreie Ablesung (analog) | LCD-Anzeige 11 mm (digital) | Datenausgang USB Proximity (digital) | Hold- und Preset-Funktion (digital) | mit Feineinstellung | Feststellschraube | Stahlfuß mit Schmutznuten | Hartmetall bestückte Anreißnadel | Werknorm | Made in Germany
analog or digital | satin chrome finished (analog) | parallax-free (analog) | LCD display 11 mm (digital) | data output USB Proximity (digital) | Hold- and Preset-function (digital) | with fine adjustment | set screw | steel base with dirt groove | carbide-tipped scriber | factory standard | Made in Germany



46-652

46-661

Art.-Nr. Order no.	Typ Type	Ablesung Reading	Messbereich Range	EUR
46-651	analog	0,02 mm	0-300 mm	379,00
46-652			0-600 mm	478,00
46-653			0-1000 mm	657,00
46-661	digital	0,01 mm	0-300 mm	549,00
46-662			0-600 mm	688,00
46-663			0-1000 mm	953,00

Ersatz-Anreißnadeln:
spare part scriber:

Art.-Nr. Order no.	Länge Length	EUR
46-658	75 mm	119,00
46-659	150 mm	135,00

USB-Datenübertragungskabel Proximity (nur für digitale Varianten):
USB interface data cable Proximity (for digital variants only)



Art.-Nr. Order no.	Länge Length	EUR
46-195	2 m	144,00

Weitere Informationen und Zubehör zum Thema Datenübertragung finden Sie in Kapitel 15!
Further information and accessories related to data transfer can be found in chapter 15!

Anreißwerkzeuge, Lineale Marking gauges, rulers

SYLVAC Motorisches Digital-Höhenmessgerät mit Datenausgang *Motor-driven digital height gauge with data output*



Motorisches Messen von Innen- und Außendurchmessern, Achsabständen, Höhen, Dicken, Tiefen und Konturen | Auflösung 0,001 mm | Fehlergrenze (μm): $2,5 + L/175$ | Taster-Messkraft 0,3 N | Datenausgang USB / RS232 / Wireless | Swiss Quality | Lieferung inkl. Ladegerät, Rubin-Messeinsatz $\varnothing 3$ mm, Einstelllehre, Schutzhülle, Prüfprotokoll und Gebrauchsanweisung

Motor-driven measuring of inside and outside diameter, centre to centre distance, height, thickness, depth and contours | reading 0.001 mm | accuracy (μm): $2.5 + L/175$ | feeler measuring force 0.3 N | data output USB / RS232 / Wireless | Swiss Quality | Delivery incl. charging device, ruby measuring feeler $\varnothing 3$ mm, setting gauge, protection cover, inspection certificate and operating manual

Art.-Nr. Order no.	Messbereich Range	Gewicht Weight	EUR
19-483	0-300 mm	4,6 kg	3590,00
19-484	0-450 mm	6,8 kg	3990,00

19-483

Zubehör auf Anfrage!
Accessories on request!

Anreiß-Messschieber *Marking caliper*

Ablesung 0,05 mm | gehärteter Spezialstahl | Ablese­teile mattverchromt | mit Feineinstellung | Aufbewahrungsbox
Reading 0.05 mm | special steel, hardened | satin chrome finished | with fine adjustment | box

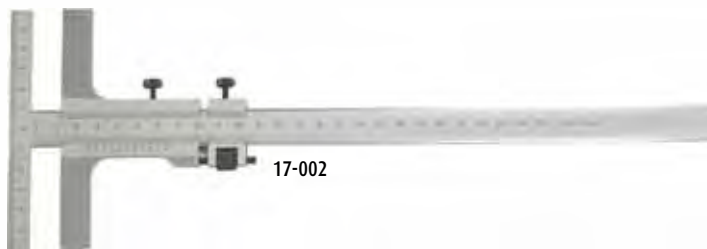

17-002

Art.-Nr. Order no.	Messbereich Range	Brückenlänge Length of base	EUR
17-002	250 mm	140 mm	92,50
17-003	300 mm	160 mm	118,00
17-005	500 mm		186,00

HELIOS-PREISSER Anreiß-Messschieber *Marking caliper*

Ablesung 0,05 mm | gehärteter rostfreier Stahl | Ablese­teile mattverchromt | mit Feineinstellung und Feststellschraube | Made in Germany
Reading 0.05 mm | hardened stainless steel | satin chrome finished | with fine adjustment and set screw | Made in Germany

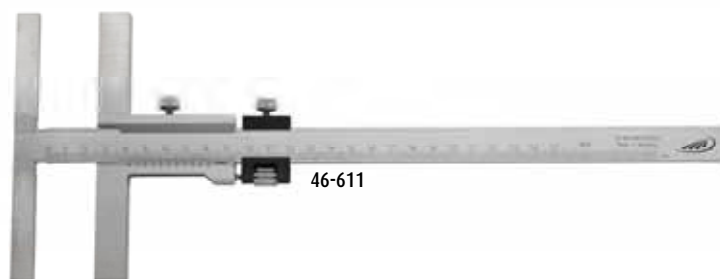

46-611

Art.-Nr. Order no.	Messbereich Range	Brückenlänge Length of base	EUR
46-610	160 mm	135 mm	127,00
46-611	250 mm		163,00
46-612	300 mm	160 mm	206,00
46-613	500 mm		437,00

Anreißwerkzeuge, Lineale Marking gauges, rulers

Anreiß-Messschieber mit Rolle *Marking caliper with roll*

Ablesung 0,05 mm | rostfreier Stahl | Ablese­teile mattverchromt | Hartmetall-Anreiß­nadel | Kunstledertasche
Reading 0.05 mm | stainless steel | satin chrome finished | carbide scriber | synthetic leather bag



Art.-Nr. Order no.	Messbereich Range	EUR
17-021	200 mm	23,50
17-022	400 mm	39,00

Ersatz-Anreiß­nadeln *spare part scriber:*

Art.-Nr. Order no.	EUR
17-026	4,80

Streichmaß *Marking gauge*

rostfreier Stahl | Ablese­teile mattverchromt | Anreiß­kante gehärtet
stainless steel | satin chrome finished | hardened marking edge



Art.-Nr. Order no.	Messbereich Range	EUR
17-041	200 mm	17,80
17-042	250 mm	19,50
17-043	300 mm	21,50

HELIOS-PREISSER Streichmaß *Marking gauge*

rostfreier Stahl | zum Anreiß­en nach Skala sowie zum Anreiß­en von 45°- bzw. 90°-Gehrungen | Feststellschraube | Made in Germany
stainless steel | for marking with scale and marking of 45° and 90° angles | set screw | Made in Germany



Art.-Nr. Order no.	Messbereich Range	EUR
46-615	100 mm	16,80
46-616	200 mm	21,50

Leichtmetall-Streichmaß *Light metal marking gauge*

Ablesung 0,05 mm | aus gehärtetem Dur-Aluminium (HRC63) | kratzfeste, schwarz eloxierte Oberfläche | lasergravierte Skala | Made in Germany
Reading 0.05 mm | made from hardened aluminium (HRC63) | scratch-proof, black anodized surface | laser engraved scale | Made in Germany



Art.-Nr. Order no.	Messbereich Range	EUR
17-046	200 mm	15,50
17-047	250 mm	16,90
17-048	300 mm	18,00

Leichtmetall-Streichmaß mit Gradmesser *Light metal marking gauge with protractor*

Kombination aus Streichmaß und Gradmesser und dadurch sehr vielseitig einsetzbar | Ablesung 0,1 mm / 1° | aus gehärtetem Dur-Aluminium (HRC63) | kratzfeste, schwarz eloxierte Oberfläche | lasergravierte Skala | Made in Germany
Combined marking gauge and protractor and thereby very multifunctional applicable | Reading 0.1 mm / 1° | made from hardened aluminium (HRC63) | scratch-proof, black anodized surface | laser engraved scale | Made in Germany



Art.-Nr. Order no.	Messbereich Range	EUR
17-051	200 mm	49,50
17-052	250 mm	52,50
17-053	300 mm	54,50

Anreißwerkzeuge, Lineale Marking gauges, rulers

Zentrierwinkel *Centering angle*

zum Anreißen des Mittelpunkts einer Welle | Werkzeugstahl | Ableseteile mattverchromt | Kunstledertasche
for scribing the centre of a shaft | carbon steel | satin chrome finished | synthetic leather bag

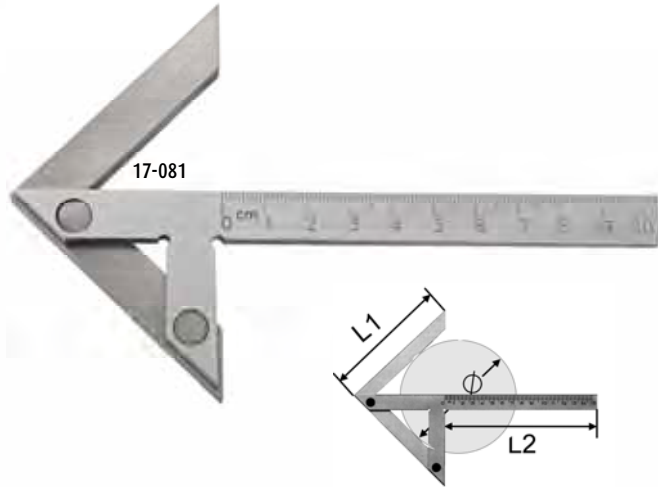

Art.-Nr. Order no.	Abmessung L2xL1 dimensions L2xL1	max. Wellen-Ø max. shaft Ø	EUR
17-081	100x70 mm	90 mm	26,80
17-082	150x130 mm	190 mm	31,00
17-083	200x150 mm	220 mm	41,50
17-084	250x160 mm	230 mm	58,50
17-085	300x180 mm	280 mm	74,50
17-086	400x240 mm	400 mm	143,00
17-087	500x300 mm	520 mm	189,00

HELIOS-PREISSER Zentrierwinkel *Centering angle*

zum Anreißen des Mittelpunkts einer Welle | Spezialstahl | Ableseteile mattverchromt (bis 300 mm) | Made in Germany
for scribing the centre of a shaft | special steel | satin chrome finished (up to 300 mm) | Made in Germany

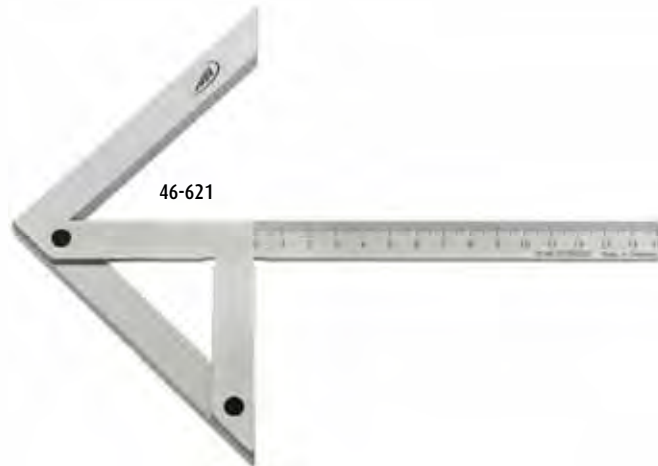

Art.-Nr. Order no.	Abmessung L2xL1 dimensions L2xL1	max. Wellen-Ø max. shaft Ø	EUR
46-620	100x70 mm	90 mm	56,00
46-621	150x130 mm	190 mm	67,00
46-622	200x150 mm	220 mm	83,50
46-623	250x160 mm	230 mm	92,50
46-624	300x180 mm	280 mm	99,50
46-625	400x250 mm	380 mm	257,00
46-626	500x330 mm	530 mm	456,00

Leichtmetall-Zentrierwinkel *Light metal centering angle*

zum Anreißen des Mittelpunkts einer Welle | aus gehärtetem Dur-Aluminium (HRC63) | kratzfeste, schwarz eloxierte Oberfläche | lasergravierte Skala |
Made in Germany
for scribing the centre of a shaft | made from hardened aluminium (HRC63) | scratch-proof, black anodized surface | laser engraved scale |
Made in Germany

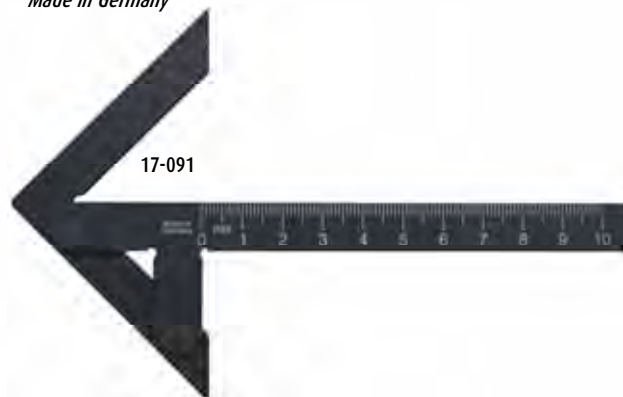

Art.-Nr. Order no.	Abmessung L2xL1 dimensions L2xL1	max. Wellen-Ø max. shaft Ø	EUR
17-091	100x70 mm	90 mm	19,80
17-092	150x130 mm	190 mm	24,80
17-093	200x150 mm	220 mm	31,00
17-094	250x160 mm	230 mm	46,50
17-095	300x180 mm	280 mm	54,50
17-096	400x240 mm	400 mm	125,00
17-097	500x300 mm	520 mm	146,00

Anreißwerkzeuge, Lineale Marking gauges, rulers

Bogenzirkel Wing dividers



aus Stahl geschmiedet | mit gehärteten Spitzen | Schraubcharnier | DIN 6486
made of forged steel | hardened points | screw hinge | DIN 6486

Art.-Nr. Order no.	Länge Length	EUR	Art.-Nr. Order no.	Länge Length	EUR
17-131	150 mm	7,90	17-135	400 mm	22,50
17-132	200 mm	8,90	17-136	500 mm	27,50
17-133	250 mm	11,50	17-139	1000 mm	79,00
17-134	300 mm	14,50			

HELIOS-PREISSER Bogenzirkel Wing dividers

aus Spezialstahl | mit gehärteten Spitzen | Nietscharnier | gerändelte Feststellschraube | optional mit Bleistifthalter
made of special steel | hardened points | rivet hinge | knurled set screw | optional with pencil holder



Länge Length	Art.-Nr. Order no.	EUR	Art.-Nr. Order no.	EUR
150 mm	46-630	10,50	46-630B*	13,50
200 mm	46-632	12,40	46-632B*	15,30
300 mm	46-634	21,40	46-634B*	23,90
400 mm	46-635	59,00		
500 mm	46-636	72,50		
800 mm	46-638	129,00	*mit Bleistifthalter	
1000 mm	46-639	179,00	*with pencil holder	

Zirkel-Messschieber Compass vernier caliper

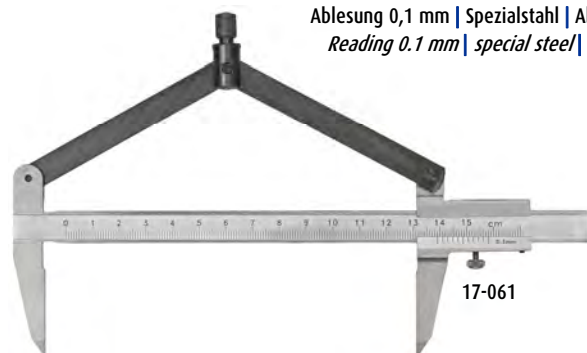

Ablesung 0,1 mm | Spezialstahl | Ablese-teile mattverchromt | Aufbewahrungsbox
Reading 0.1 mm | special steel | satin chrome finished | box

Art.-Nr. Order no.	Messbereich Range	EUR
17-061	150 mm	52,50
17-062	200 mm	56,50
17-063	300 mm	67,50

HELIOS-PREISSER Stangenzirkel Beam compass



Stange aus Spezialstahl | mit Führungsnut | mit gehärteten Anreißspitzen | Feststellschrauben | optional mit Feineinstellung
Rod made of special steel | with guide slot | hardened points | set screws | optional with fine adjustment

Messbereich (Radius) Range (radius)	ohne Feineinstellung without fine adjustment		mit Feineinstellung with fine adjustment	
	Art.-Nr. Order no.	EUR	Art.-Nr. Order no.	EUR
500 mm	46-640	67,00	46-640F	79,50
1000 mm	46-641	94,50	46-641F	107,00
☒ 1500 mm	46-642	122,00	46-642F	139,00
☒ 2000 mm	46-643	167,00	46-643F	181,00
☒ 3000 mm	46-644	383,00	46-644F	399,00
☒ 4000 mm	46-645	624,00	46-645F	629,00
☒ 5000 mm	46-646	823,00	46-646F	828,00

Anreißwerkzeuge, Lineale Marking gauges, rulers

Reißnadeln *Scribers*

Kraftanreißer | Hartmetall-Spitze | Länge 150 mm
heavy duty scriber | carbide tip | length 150 mm



Art.-Nr. Order no.	EUR
17-104	5,90

mit Clip | Hartmetall-Spitze | Länge 160 mm
with clip | carbide tip | length 160 mm



Art.-Nr. Order no.	EUR
17-101	2,50

Kugelschreiber-Form | Hartmetall-Spitze | Länge 125 mm | auswechselbare Spitze
pen form | carbide tip | length 125 mm | changeable tip



Art.-Nr. Order no.	EUR
17-102	4,90

Ersatzspitze <i>spare part tip</i>	17-103	1,80
------------------------------------	--------	------

Werkzeugstahl | gehärtet und brüniert | Länge 175 mm
metall body | hardened and browned | length 175 mm



Art.-Nr. Order no.	EUR
17-106	1,50

Werkzeugstahl | gehärtet und brüniert | 90°-Version | Länge 250 mm
metall body | hardened and browned | 90° turned point | length 175 mm



Art.-Nr. Order no.	EUR
17-107	1,80

HELIOS-PREISSER Reißnadeln *Scribers*



Hartmetall-Spitzen | gerade/gebogene Nadel | Made in Germany
carbide tips | straight/bended scriber | Made in Germany



Art.-Nr. Order no.	EUR
46-600	8,50

Hartmetall-Spitze | Reißnadel "Kugelschreiber" mit Fallmechanik und Ansteckclip | Made in Germany
carbide tip | scriber with „ball-pen“ mechanism and clip | Made in Germany



Art.-Nr. Order no.	EUR
46-601	12,50

Ersatzspitze <i>spare part tip</i>	46-602	3,30
------------------------------------	--------	------

Anreißwerkzeuge, Lineale

Marking gauges, rulers

Fräser-Anreißnadel *Milling scriber*

Anreißen mit der Fräsmaschine | federnd gelagerte Anreißnadel mit Hartmetall-Spitze | Federweg 10 mm | Gesamtlänge 146 mm | Konzentrität 0,02 mm | Vorschubgeschwindigkeit 150 mm/min (keine Rotation notwendig)

Scribing by milling operation | spring-loaded scriber with carbide tip | range of spring 10 mm | Overall length 146 mm | Concentricity 0.02 mm | suitable feed speed 150 mm/min (not necessary to rotate)

Art.-Nr. Order no.	Einspannschaft Shank	EUR
32-051	Ø20 x 60 mm	188,00



Anwendungsbeispiel *Example of use*

Ersatz-Anreißnadel: <i>Spare part scriber:</i>	Art.-Nr. Order no.	EUR
	32-053	48,50

Schlag-Körner *Center punch*

Chrom-Vanadium-Stahl | Länge 120 mm
Chrome vanadium steel | length 120 mm



Art.-Nr. Order no.	EUR
17-111	4,40

Automatik-Körner *Automatic center punch*

selbstschlagender Automatik-Körner | Schlagkraft über Feder-Vorspannung einstellbar | Gehäuse Messing vernickelt | Hartmetall-Spitze, Härte HRA87 | Länge 135 mm

Center-punching without hammer | strength of driving force adjustable | body brass, nickel plated | carbide tip, hardness HRA87 | length 135 mm



Art.-Nr. Order no.	EUR
17-117	19,80

Automatik-Körner groß *Automatic center punch large*

selbstschlagender Automatik-Körner | Schlagkraft über Feder-Vorspannung einstellbar | Kunststoff-Gehäuse | Hartmetall-Spitze, Härte HRA87 | Länge 174 mm

Center-punching without hammer | strength of driving force adjustable | body plastics | carbide tip, hardness HRA87 | length 174 mm



Art.-Nr. Order no.	EUR
17-118	37,50

Anreißwerkzeuge, Lineale Marking gauges, rulers

HELIOS-PREISSER Maßstab **biegsam** Flexible ruler

EG-Klasse II | Teilung 0,5 mm (oben) / 1 mm (unten) | rostfreier Stahl
EG class II | Reading 0.5 mm (at the top) / 1 mm (at the bottom) | stainless steel



47-701-0200

Detailansicht: Detailed view:



Weitere Ausführungen auf Anfrage!
Further models on request!



Art.-Nr. Order no.	Länge Length	Querschnitt Cross section	EUR
47-701-0150	150 mm	13x0,5 mm	0,95
47-701-0200	200 mm		1,10
47-701-0300	300 mm	15x0,5 mm	1,60
47-701-0500	500 mm	20x0,5 mm	4,30
47-701-1000	1000 mm		9,00

HELIOS-PREISSER Maßstab **halbstarr** Rigid ruler

EG-Klasse II | Teilung 0,5 mm (oben) / 1 mm (unten) | rostfreier Stahl
EG class II | Reading 0.5 mm (at the top) / 1 mm (at the bottom) | stainless steel



47-702-0300

Weitere Ausführungen auf Anfrage!
Further models on request!



Art.-Nr. Order no.	Länge Length	Querschnitt Cross section	EUR
47-702-0300	300 mm	30x1,0 mm	3,20
47-702-0500	500 mm		7,60
47-702-1000	1000 mm		15,80
47-702-1500	1500 mm		25,50
47-702-2000	2000 mm		30,80
47-702-3000	3000 mm		69,50

VOGEL Maßstab **mattiert** Ruler mattfinished

DIN 2004/22/EG II | rostfreier Federbandstahl (biegsam) | mattierte Oberfläche | Querschnitt 18x0,5 mm | Teilung 0,5 mm
Made in Germany
DIN 2004/22/EG II | stainless spring band steel (flexible) | mattfinished surface | cross section 18x0.5 mm |
Reading 0.5 mm | Made in Germany



44-002-0150

Weitere Ausführungen auf Anfrage!
Further models on request!



Art.-Nr. Order no.	Länge Length	EUR
44-002-0150	150 mm	1,80
44-002-0300	300 mm	2,50
44-002-0400	400 mm	2,90
44-002-0500	500 mm	3,40
44-002-1000	1000 mm	8,30
44-002-1500	1500 mm	12,90
44-002-2000	2000 mm	19,90
44-002-2500	2500 mm	24,00
44-002-3000	3000 mm	27,00
44-002-3500	3500 mm	29,50
44-002-4000	4000 mm	57,00
44-002-5000	5000 mm	66,00
44-002-6000	6000 mm	87,00

Anreißwerkzeuge, Lineale Marking gauges, rulers

Maßstab mit „Aufhebe-Ecke“ Ruler with bent-up edge for easy pick-up

mit „geknickter Ecke“ zum einfachen Aufheben auf flachen Unterlagen | Teilung 1 mm | mattierte Oberfläche | rostfreier Stahl
with bent-up edge for easy pick-up from flat surfaces | Reading 1 mm | mattfinished surface | stainless steel

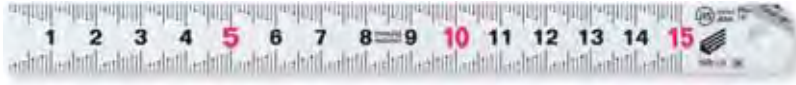

Detailansicht „Aufhebe-Ecke“ (einfach auf die Ecke drücken und der Maßstab hebt sich von der Unterlage)
Detail view bent-up edge for easy pick-up (just press on this edge and the ruler lifts itself)

Art.-Nr. Order no.	Länge Length	Genauigkeit Accuracy	EUR
20-341	150 mm	0,15 mm	3,20
20-342	300 mm		6,40
20-343	600 mm	0,20 mm	15,80

Maßstab mit Ansteck-Clip Ruler with fixing clip



verschiebbarer Ansteck-Clip, auch als Tiefenmessbrücke nutzbar | Teilung 1 mm | mattierte Oberfläche | rostfreier Stahl
Sliding clip can be used as depth gauge | Reading 1 mm | mattfinished surface | stainless steel



Art.-Nr. Order no.	Länge Length	EUR
20-347	150 mm	4,50

Maßstab mit Haken Ruler with hook

Teilung 1 mm | Genauigkeit 0,15 mm | 2fach-Anwendungsmöglichkeit | rostfreier Stahl
Reading 1 mm | Accuracy 0.15 mm | dual use | stainless steel



Art.-Nr. Order no.	Länge Length	EUR
20-351	150 mm	7,80

Anwendungsbeispiele: *Examples of use:*



Bei Bestellung mit Kalibrierung bitte beachten:

Dieser Maßstab besitzt 2 Skalen (1 oben (ohne Anschlag) und 1 unten (mit Anschlag/Haken)). Bitte geben Sie an, ob beide Skalen kalibriert werden sollen (2facher Preis) oder nur eine.

In case of ordering with calibration, please note:

This ruler has 2 scales (1 at the top (without stop) and 1 at the bottom (with stop/hook)). Please specify, whether calibration should include both scales (double price) or only one of them.



90°-Maßstab 90°-Ruler



Teilung 1 mm | Querschnitt 20x1 mm | beidseitig verwendbar | rostfreier Stahl
Reading 1 mm | cross section 20x1 mm | double-sided | stainless steel

Art.-Nr. Order no.	Länge Length	EUR
20-361	300x150 mm	23,50
20-362	500x250 mm	27,50

Bei Bestellung mit Kalibrierung bitte beachten:

Bitte angeben, welche der 4 Skalen (innen/außen und langer/kurzer Schenkel) kalibriert werden sollen! (4 Skalen = 4facher Preis)

*In case of ordering with calibration, please note
Please specify, which of the 4 scales (inside/outside & long/short leg) should be calibrated!
(4 scales = fourfold price)*

Anreißwerkzeuge, Lineale

Marking gauges, rulers

Werkstattlineal Steel ruler

für einfache Werkstattarbeiten | aus Spezialstahl geschliffen | Querschnitt 40x5 mm | Teilung 1 mm | mit Facette
 for simple workmanship | special steel, ground | cross section 40x5 mm | reading 1 mm | bevelled edge



20-321

Art.-Nr. Order no.	Länge Length	EUR
20-321	300 mm	18,50
20-322	500 mm	22,50
20-323	600 mm	32,00
20-324	800 mm	39,50
20-325	1000 mm	44,50
20-326	1500 mm	107,00
20-327	2000 mm	167,00

HELIOS-PREISSER Präzisions-Stahllineal Precision steel ruler

Arbeitsmaßstab nach DIN 866 Form A oder B | Teilung 1 mm | Form A: beidseitig 10 mm Schutzenden /
 Form B: Skalierungsanfang an Stirnkante, einseitig 10 mm Schutzende | Made in Germany
 Precision ruler according to DIN 866 type A or B | reading 1 mm | Type A: 10 mm protection ends on both sides /
 Type B: begin of scale at front border, 10 mm protection end on one side | Made in Germany

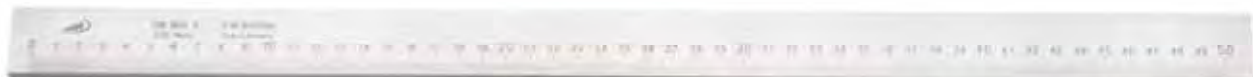

47-705-0500



47-707-0500



Form A Type A



Form B Type B

	Länge Length	Querschnitt Cross section	Stahl steel		rostfreier Stahl stainless steel	
			Art.-Nr. Order no.	EUR	Art.-Nr. Order no.	EUR
Form A Type A	500 mm	30x6 mm	47-705-0500	25,50	47-706-0500	45,00
	1000 mm	40x8 mm	47-705-1000	58,00	47-706-1000	103,00
	1500 mm	50x10 mm	47-705-1500	104,00	47-706-1500	153,00
	2000 mm		47-705-2000	144,00	47-706-2000	269,00
	3000 mm		47-705-3000	298,00	47-706-3000	541,00
	4000 mm		47-705-4000	541,00	47-706-4000	978,00
Form B Type B	500 mm	25x5 mm	47-707-0500	19,80	47-708-0500	26,50
	1000 mm	30x6 mm	47-707-1000	39,50	47-708-1000	58,00
	1500 mm		47-707-1500	57,00	47-708-1500	99,00
	2000 mm	40x8 mm	47-707-2000	93,50	47-708-2000	157,00
	2500 mm		47-707-2500	147,00	47-708-2500	299,00
	3000 mm		47-707-3000	163,00	47-708-3000	312,00
	4000 mm	50x10 mm	47-707-4000	311,00	47-708-4000	561,00
	5000 mm	60x12 mm	47-707-5000	559,00	47-708-5000	1068,00

Anreißwerkzeuge, Lineale Marking gauges, rulers

Präzisions-Glasmaßstab Precision glass scale

Zum Kalibrieren von Profilprojektoren, Messmikroskopen, u. ä. | Teilung 1 mm
for calibration of profile projectors, measuring microscopes, etc. | reading 1 mm

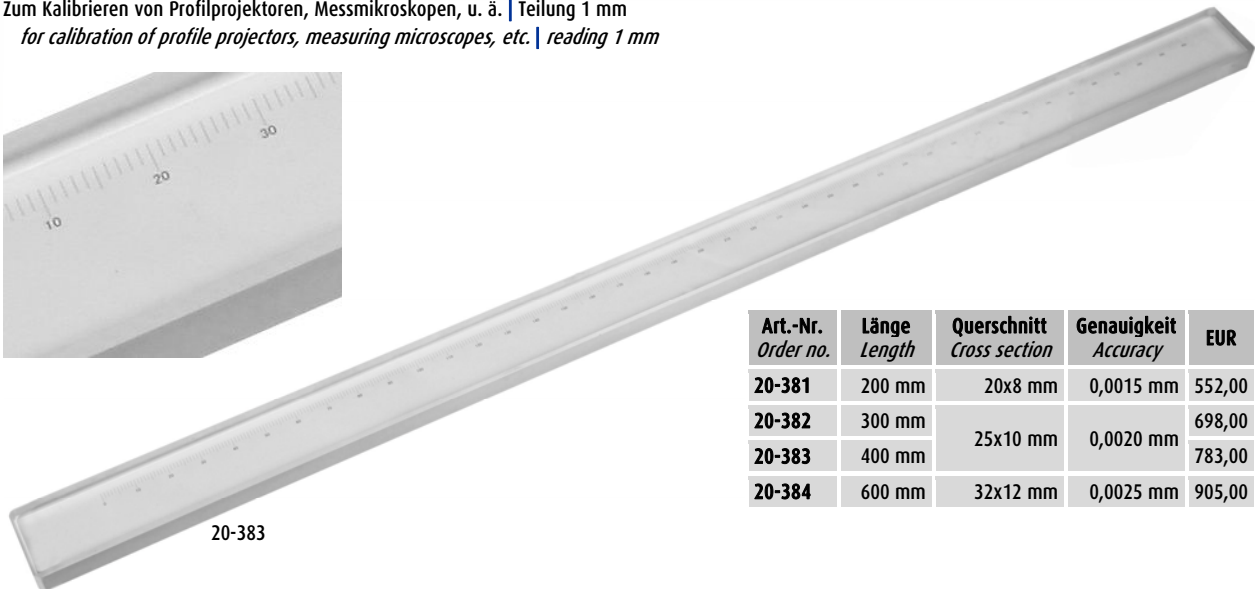

20-383

Art.-Nr. Order no.	Länge Length	Querschnitt Cross section	Genauigkeit Accuracy	EUR
20-381	200 mm	20x8 mm	0,0015 mm	552,00
20-382	300 mm	25x10 mm	0,0020 mm	698,00
20-383	400 mm			783,00
20-384	600 mm	32x12 mm	0,0025 mm	905,00

Maßstab-Aufkleber Scale sticker

Teilung 1 mm | selbstklebende PET-Folie, ablösbar | 4x weißer Hintergrund, 4x schwarzer Hintergrund | Made in Japan
Reading 1 mm | self-adhesive PET-foil, removable | 4x white background, 4x black background | Made in Japan



Art.-Nr. Order no.	Länge Length	EUR
20-370	8x 100 mm	1,85

Selbstklebender Maßstab Scale tape

Teilung 1 mm | Querschnitt 13x0,3 mm | beschichtetes Stahlband | einfach auf gewünschte Länge kürzbar
Reading 1 mm | cross section 13x0.3 mm | coated steel band | easy to cut for desired length



Art.-Nr. Order no.	Länge Length	EUR
20-371	2000 mm	4,60

Einfach mit Schere kürzen: simply cut with scissors:



Anreißwerkzeuge, Lineale Marking gauges, rulers

VOGEL Gliedermaßstab *Folding meter*

Messbereich 2000 mm | Ablesung 1 mm | EG-Klasse III gem. MID | Holz mit wasserabweisendem UV-Lack | professionelle Ausführung für langfristig hohe Belastungen | Made in Germany

Range 2000 mm | Reading 1 mm | EG class III acc. MID | wood with water-repellent UV finish | professional model for long-term high stress | Made in Germany



Art.-Nr. Order no.	EUR
44-044	3,50



VOGEL Taschen-Bandmaß *Pocket measuring tape*

gelbes, acrylbeschichtetes Skalenband mit hoher Abriebfestigkeit und Knickstabilität | Teilung 1 mm | EG-Klasse II | mit Metall-Gürtelclip und Handschleife

yellow, acrylic coated scale tape with high abrasion resistance and buckling stability | Reading 1 mm | EG class II | with metal belt clip and supporting loop



44-021

Art.-Nr. Order no.	Messbereich Range	Bandbreite Tape width	EUR
44-021	3 m	16 mm	3,30
44-022	5 m	19 mm	4,50
44-024	10 m	25 mm	9,20

Digital-Bandmaß *Digital measuring tape*

Messbereich 5 m | Auflösung 0,1 cm | cm / inch | EG-Klasse III | beschichtetes Stahlband | Innen- und Außenmessungen möglich (bei Innenmessungen wird die Gehäuse-Länge hinzuaddiert) | mit Metall-Gürtelclip und Handschleife

Measuring range 5 m | Reading 0.1 cm | cm / inch | EG class III | coated steel band | inside and outside measuring mode (inside measurements add length of housing) | with metal belt clip and supporting loop

Art.-Nr. Order no.	EUR
20-331	31,00



Anreißwerkzeuge, Lineale Marking gauges, rulers

VOGEL Stahl-Messband *Steel measuring tape*

Maßband aus Stahl, schwarze Beschriftung, Schutzlack gegen Abrieb | Teilung 1 mm | EG-Klasse II | Bandbreite 13 mm |
Made in Germany

*Measuring tape from steel, black lettering, protective lacquer against abrasion | Reading 1 mm | EG class II |
tape width 13 mm | Made in Germany*



	Art.-Nr. Order no.	Messbereich Range	EUR
Typ A <i>Type A</i>	44-010	20 m	29,80
	44-012	50 m	51,50
Typ B <i>Type B</i>	44-015	20 m	29,80
	44-017	50 m	51,50
Typ C <i>Type C</i>	44-018	20 m	29,80
	44-019	50 m	51,50

Messanfang

Begin of scale

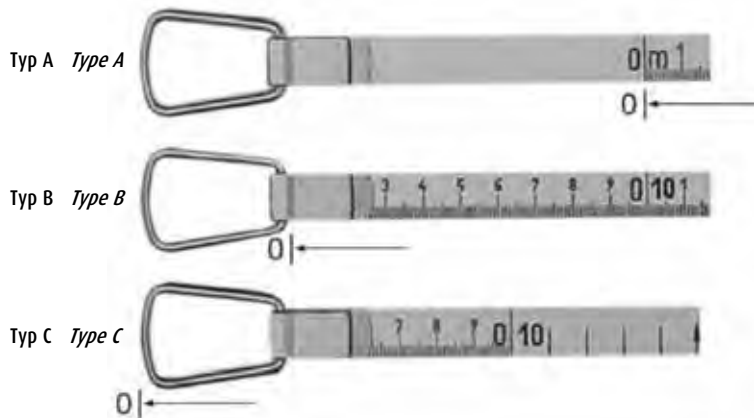

VOGEL Laser-Entfernungsmesser *Laser distance meter*

Messbereich 0,5-80 m | Auflösung 0,001 m | Genauigkeit ± 2 mm | Abmessungen 120x50x25 mm | direkte oder indirekte Messungen (z. B. Bestimmung einer Strecke mit zwei oder drei Hilfsmessungen) | Farb-Display mit Hintergrundbeleuchtung und Anzeige Ladezustand | Speicherfunktion für 20 Messungen | m/inch/ft umschaltbar | rückseitig mit Gewinde M6 für Stativbefestigung | Betriebstemperatur -10°C bis +40°C | automatische Abschaltung | inkl. Gürtelschleufe, Handschleufe, Batterien



Range 0.5-80 m | reading 0.001 m | accuracy ± 2 mm | dimensions 120x50x25 mm | direct or indirect measurements (e. g. determination of a distance with two or three auxiliary measurements) | color-display with background lighting and information about battery status | saving of 20 measured values | switchable between m/inch/ft | thread M6 on backside for stand fixing | operating temperature -10°C to +40°C | automatic power-off | incl. belt loop, supporting loop, batteries



Art.-Nr. Order no.	EUR
44-081	49,00

Winkel, Winkelmesser

Squares, protractors



Inhalt Contents



06.2



06.8



06.10



06.12



06.14

Normen Standards

Alle unsere Winkel nach DIN 875 erfüllen folgende Werte:

All our squares according to DIN 875 comply with following values:

Seitenlänge des langen Schenkels (mm) <i>length of long leg (mm)</i>	50	75	100	150	200	250	300	500	750	1000
Rechtwinkligkeitstoleranz Tol.klasse 00 (μm) <i>tolerance of rectangularity tol. class 00 (μm)</i>	3	3	3	4	4	5	5	7	10	12
Rechtwinkligkeitstoleranz Tol.klasse 0 (μm) <i>tolerance of rectangularity tol. class 0 (μm)</i>	-	7	7	8	9	10	11	15	20	25
Rechtwinkligkeitstoleranz Tol.klasse 1 (μm) <i>tolerance of rectangularity tol. class 1 (μm)</i>	-	14	15	18	20	23	25	35	48	60
Rechtwinkligkeitstoleranz Tol.klasse 2 (μm) <i>tolerance of rectangularity tol. class 2 (μm)</i>	-	28	30	35	40	45	50	70	95	120

Weitere Informationen: siehe DIN 875 (DIN Deutsches Institut für Normung e. V., erschienen im Beuth Verlag)

Further information: see DIN 875 (DIN Deutsches Institut für Normung e. V., published by Beuth Verlag)

Kalibrierung Calibration

Informationen zur Kalibrierung erhalten Sie in Kapitel 15!

Information about calibration can be found in chapter 15!

Winkel, Winkelmesser Squares, protractors

Schlosserwinkel *Steel squares for locksmith*

für einfache Werkstattarbeiten | Spezialstahl | verzinkt
for simple workmanship | special steel | zinc plated



Abmessung dimensions	flach flat		mit Anschlag with base	
	Art.-Nr. Order no.	EUR	Art.-Nr. Order no.	EUR
150x100 mm	20-580	4,50	20-590	6,40
200x130 mm	20-581	4,80	20-591	7,80
250x165 mm	20-582	5,90	20-592	10,50
300x200 mm	20-583	7,40	20-593	12,40
400x230 mm	20-584	9,20	20-594	15,20
500x280 mm	20-585	10,80	20-595	19,50
600x330 mm	20-586	12,40	20-596	26,50
750x375 mm	20-587	16,00	20-597	33,80
800x430 mm	20-588	17,50	20-598	39,50
1000x500 mm	20-589	23,50	20-599	49,50

90°-Maßstab *90°-Ruler*

Teilung 1 mm | Querschnitt 20x1 mm | beidseitig verwendbar | rostfreier Stahl
Reading 1 mm | cross section 20x1 mm | double-sided | stainless steel



Art.-Nr. Order no.	Länge Length	EUR
20-361	300x150 mm	23,50
20-362	500x250 mm	27,50

HELIOS-PREISSER Flanschenwinkel *Flange squares*

zum rechtwinkligen Ausrichten von Flanschen | Spezialstahl verzinkt | Querschnitt 30x5 mm
for perpendicular positioning of flanges | galvanized special steel | cross section 30x5 mm

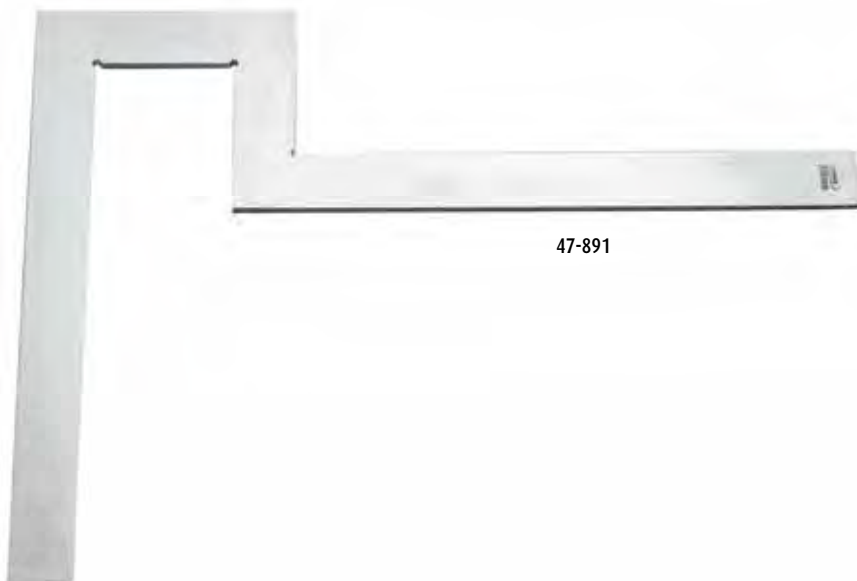

Art.-Nr. Order no.	Schenkellänge Length of legs	EUR
47-891	300x300 mm	16,50
47-892	400x400 mm	19,50
47-893	500x500 mm	23,00

Winkel, Winkelmesser Squares, protractors

HELIOS-PREISSER Präzisions-Stahlwinkel Precision squares

DIN 875 | Flachwinkel oder Anschlagwinkel | Stahl oder rostfreier Stahl | Made in Germany
DIN 875 | Flat or with base | Steel or stainless steel | Made in Germany



	Abmessung Dimensions (mm)	Stahl steel				rostfreier Stahl stainless steel			
		flach flat		mit Anschlag with base		flach flat		mit Anschlag with base	
		Art.-Nr. Order no.	EUR	Art.-Nr. Order no.	EUR	Art.-Nr. Order no.	EUR	Art.-Nr. Order no.	EUR
Toleranzklasse 0 tolerance class 0	75x50	47-910-02	16,90	47-930-02	24,50	47-920-02	31,50	47-940-02	46,50
	100x70	47-910-03	18,50	47-930-03	27,50	47-920-03	38,50	47-940-03	55,00
	150x100	47-910-04	22,50	47-930-04	36,50	47-920-04	47,00	47-940-04	76,00
	200x130	47-910-05	31,50	47-930-05	47,00	47-920-05	72,50	47-940-05	103,00
	250x165	47-910-06	42,50	47-930-06	62,50	47-920-06	95,00	47-940-06	144,00
	300x200	47-910-07	58,50	47-930-07	77,50	47-920-07	116,00	47-940-07	185,00
	400x265	47-910-08	118,00	47-930-08	169,00	47-920-08	198,00	47-940-08	287,00
	500x330	47-910-09	155,00	47-930-09	248,00	47-920-09	276,00	47-940-09	396,00
	600x400	47-910-10	248,00	47-930-10	349,00	47-920-10	464,00	47-940-10	589,00
	750x500	47-910-11	461,00	47-930-11	698,00	47-920-11	864,00	47-940-11	995,00
	1000x660	47-910-12	822,00	47-930-12	1180,00	47-920-12	1620,00	47-940-12	2145,00
	Toleranzklasse 1 tolerance class 1	75x50	47-911-02	9,90	47-931-02	14,90	47-921-02	10,80	47-941-02
100x70		47-911-03	11,50	47-931-03	16,90	47-921-03	12,90	47-941-03	18,50
150x100		47-911-04	14,50	47-931-04	23,00	47-921-04	15,90	47-941-04	28,50
200x130		47-911-05	18,80	47-931-05	29,00	47-921-05	24,00	47-941-05	37,00
250x165		47-911-06	26,50	47-931-06	39,00	47-921-06	32,80	47-941-06	51,00
300x200		47-911-07	34,00	47-931-07	49,00	47-921-07	41,00	47-941-07	67,50
400x265		47-911-08	79,50	47-931-08	97,00	47-921-08	135,00	47-941-08	169,00
500x330		47-911-09	105,00	47-931-09	142,00	47-921-09	172,00	47-941-09	219,00
600x400		47-911-10	146,00	47-931-10	199,00	47-921-10	264,00	47-941-10	343,00
750x500		47-911-11	275,00	47-931-11	398,00	47-921-11	483,00	47-941-11	533,00
1000x660		47-911-12	471,00	47-931-12	676,00	47-921-12	779,00	47-941-12	859,00
Toleranzklasse 2 tolerance class 2		75x50	47-912-02	8,50	47-932-02	11,80			
	100x70	47-912-03	9,50	47-932-03	13,50				
	150x100	47-912-04	11,50	47-932-04	17,90				
	200x130	47-912-05	14,90	47-932-05	22,90				
	250x165	47-912-06	19,50	47-932-06	31,00				
	300x175	47-912-07	26,00	47-932-07	39,00				
	400x200	47-912-08	41,50	47-932-08	57,50				
	500x250	47-912-09	58,00	47-932-09	69,50				
	600x300	47-912-10	74,50	47-932-10	93,00				
	750x375	47-912-11	92,00	47-932-11	118,00				
	1000x500	47-912-12	143,00	47-932-12	172,00				
	1500x750	47-912-13	685,00	47-932-13	755,00				
	2000x1000	47-912-14	828,00	47-932-14	929,00				



Informationen zu den Toleranzklassen finden Sie auf Seite 06.1!

Information about tolerance classes can be found on page 06.1!



Holz-Aufbewahrungsbox: siehe Folgeseite!
Wooden box: see following page!

Winkel, Winkelmesser Squares, protractors

HELIOS-PREISSER Präzisions-Stahlwinkel **gehärtet** Precision squares

DIN 875 Toleranzklasse 0 | Flachwinkel oder Anschlagwinkel | gehärteter Stahl oder gehärteter rostfreier Stahl |
Made in Germany
DIN 875 tolerance class 0 | Flat or with base | Hardened steel or hardened stainless steel | Made in Germany



Abmessung Dimensions (mm)	Stahl steel			
	flach flat		mit Anschlag with base	
	Art.-Nr. Order no.	EUR	Art.-Nr. Order no.	EUR
50x40	47-950-1	18,50	47-970-1	24,90
75x50	47-950-2	19,80	47-970-2	26,50
100x70	47-950-3	24,50	47-970-3	31,50
150x100	47-950-4	29,80	47-970-4	47,50
200x130	47-950-5	39,50	47-970-5	66,00
300x200	47-950-6	76,00	47-970-6	115,00

Abmessung Dimensions (mm)	rostfreier Stahl stainless steel			
	flach flat		mit Anschlag with base	
	Art.-Nr. Order no.	EUR	Art.-Nr. Order no.	EUR
50x40	47-960-1	23,50	47-980-1	34,50
75x50	47-960-2	26,80	47-980-2	38,50
100x70	47-960-3	31,50	47-980-3	47,50
150x100	47-960-4	41,00	47-980-4	63,00
200x130	47-960-5	52,50	47-980-5	79,50
300x200	47-960-6	105,00	47-980-6	119,00

HELIOS-PREISSER Holz-Aufbewahrungsbox für Stahlwinkel Wooden box for precision squares

mit Schaumstoff-Einlage
with foam inlay



Art.-Nr. Order no.	für Winkel for squares	für Flachwinkel for flat squares	für Anschlagwinkel for squares with base	Innenmaße Inside dimensions	EUR
47-999-01	50x40 mm	X	X	55x45x22 mm	3,95
47-999-02	75x50 mm	X	X	80x55x22 mm	4,50
47-999-03	100x70 mm	X	X	105x75x22 mm	4,70
47-999-04	150x100 mm	X		160x105x22 mm	5,90
47-999-05			X	160x105x27 mm	6,50
47-999-06	200x130 mm	X		210x135x27 mm	7,50
47-999-07			X	210x135x34 mm	8,80
47-999-08	250x165 mm	X		260x170x27 mm	8,30
47-999-09			X	260x170x38 mm	19,00
47-999-10	300x200 mm	X		312x205x27 mm	11,40
47-999-11			X	312x205x42 mm	19,00
47-999-12	400x265 mm	X		412x270x27 mm	32,50
47-999-13			X	412x270x48 mm	36,00
47-999-14	500x330 mm	X		512x335x27 mm	36,00
47-999-15			X	512x335x54 mm	39,50

Winkel, Winkelmesser Squares, protractors

HELIOS-PREISSER Stahlwinkel 45°/60°/120°/135° Squares 45°/60°/120°/135°

Spezialstahl | Made in Germany
Special steel | Made in Germany

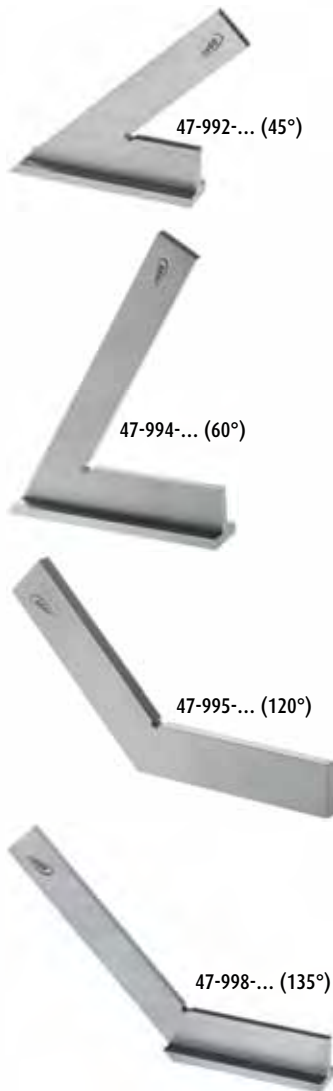

	Abmessung Dimensions (mm)	Querschnitt Cross section (mm)	flach flat		mit Anschlag with base	
			Art.-Nr. Order no.	EUR	Art.-Nr. Order no.	EUR
45°	120x80	20x5	47-991-1	19,30	47-992-1	27,50
	150x100		47-991-2	21,00	47-992-2	30,50
	200x130		47-991-3	30,50	47-992-3	41,00
60°	120x80	20x5	47-993-1	18,60	47-994-1	26,00
	150x100		47-993-2	20,80	47-994-2	29,80
	200x130		47-993-3	29,00	47-994-3	39,50
120°	50x50	15x5	47-995-1	8,30		
	75x75	18x5	47-995-2	10,60		
	100x100	20x5	47-995-3	12,80		
135°	50x50	15x5	47-997-1	8,30		
	75x75	18x5	47-997-2	10,60		
	100x100	20x5	47-997-3	12,80		
	120x80		47-997-4	13,50	47-998-4	18,60
	150x100	47-997-5	18,30	47-998-5	21,00	
	200x130	25x5	47-997-6	24,80	47-998-6	27,50

Mehrfach-Winkel Multiple angle square

Spezialstahl | Winkel 30°/45°/90°/120° | mit Anschlag | Genauigkeit 0,05°
Special steel | Angles 30°/45°/90°/120° | with base | Accuracy 0.05°



Art.-Nr. Order no.	Größe (Länge des langen Schenkels) Size (length of long leg)	EUR
20-181	100 mm	38,50
20-183	150 mm	46,50
20-184	200 mm	82,00
20-185	300 mm	107,00

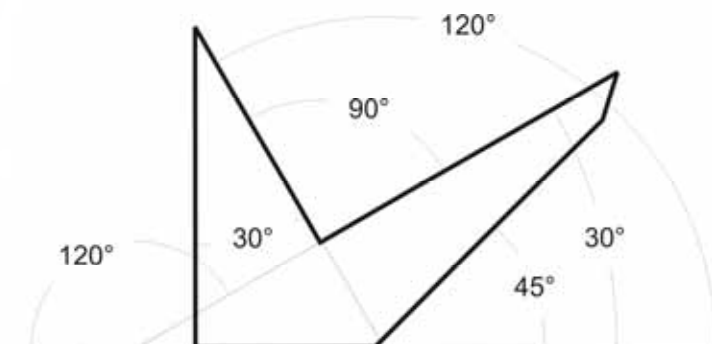

Winkel, Winkelmesser Squares, protractors

Präzisions-Winkel aus Granit *Precision granite squares*



90° | Toleranzklasse 0 | inkl. Hersteller-Prüfprotokoll
90° | tolerance class 0 | incl. manufacturers inspection certificate

Art.-Nr. Order no.	Abmessung dimensions	Rechtwinkligkeit Squareness	Gewicht weight	EUR
20-091	100x63x16 mm	7 µm	0,4 kg	88,50
20-092	160x100x20 mm	8 µm	0,9 kg	113,00
20-093	250x160x25 mm	10 µm	2,4 kg	167,00
20-094	400x250x40 mm	13 µm	8,1 kg	278,00
20-095	630x400x63 mm	18 µm	30,1 kg	☛ 658,00
20-096	1000x630x80 mm	25 µm	101 kg	☛ 1595,00

OELZE Hartgestein-Präzisionswinkel *Hard stone precision squares*



zur Kontrolle des 90°-Winkels | Schenkelflächen rechtwinklig zueinander geläppt | ab 500x300 mm mit Gewindeeinsätzen für den Transport | Lieferung inkl. Hersteller-Prüfprotokoll | Made in Germany
for checking 90° angles | legs right-angled lapped | from 500x300 mm with thread inserts for transport | delivery with manufacturers inspection certificate | Made in Germany



Abmessungen dimensions	Gewicht weight	Güte 000 tolerance class 000			Güte 00 tolerance class 00		
		Art.-Nr. Order no.	Recht- winkligkeit Squareness	EUR	Art.-Nr. Order no.	Recht- winkligkeit Squareness	EUR
300x200x50 mm	6 kg	48-221	1,5 µm	705,00	48-211	2,5 µm	579,00
400x250x50 mm	8,5 kg	48-222		884,00	48-212		756,00
500x300x60 mm	15 kg	48-223	2 µm	1120,00	48-213	3 µm	991,00
600x400x70 mm	☛ 28 kg	48-224		1385,00	48-214		1260,00
800x600x90 mm	☛ 69 kg	48-225	2,5 µm	2020,00	48-215	3,5 µm	1890,00
1000x600x120 mm	☛ 130 kg	48-226	3 µm	2810,00	48-216	4 µm	2480,00
1500x1000x160 mm	☛ 380 kg	48-228	4 µm	6080,00	48-218	5 µm	5730,00

Hartgestein-Winkelnormale *Hard stone square standards*

90°-Winkelnormal | Toleranzklasse 0 | rechteckig, quadratisch oder würfelförmig | inkl. Hersteller-Prüfprotokoll
90° standard | tolerance class 0 | rectangular, quadratic or cubical | incl. manufacturers inspection certificate



20-036



20-051

Art.-Nr. Order no.	Abmessung dimensions	Form design	Gewicht weight	EUR
20-031	300x200x20 mm	Rechteckig/ quadratisch Rectangular/ quadratic	8 kg	188,00
20-032	400x250x60 mm		17 kg	359,00
20-033	400x400x60 mm		23 kg	485,00
20-034	500x500x70 mm		37 kg	☛ 698,00
20-035	600x300x80 mm		37 kg	☛ 756,00
20-036	600x600x80 mm		68 kg	☛ 910,00
20-037	800x400x100 mm		75 kg	☛ 985,00
20-038	800x800x100 mm		150 kg	☛ 1285,00
20-039	1000x500x120 mm		130 kg	☛ 1780,00
20-051	150x150x150 mm	Würfel cubical	10 kg	248,00
20-052	300x300x300 mm		78 kg	☛ 594,00
20-053	400x400x400 mm		185 kg	☛ 955,00
20-054	500x500x500 mm		368 kg	☛ 1365,00

Winkel, Winkelmesser

Squares, protractors

Schnittmacherwinkel *Small knife edge squares*

rostfreier Stahl | DIN 875-1, Toleranzklasse 00
stainless steel | DIN 875-1, tolerance class 00

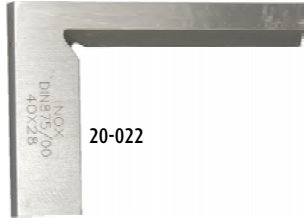

20-022

Art.-Nr. Order no.	Abmessung dimensions	EUR
20-021	25x20 mm	17,50
20-022	40x28 mm	19,50

Präzisions-Haarwinkel *Precision knife edge squares*

rostfreier Stahl | mattverchromt | DIN 875-1, Toleranzklasse 00
stainless steel | satin chrome finished | DIN 875-1, tolerance class 00

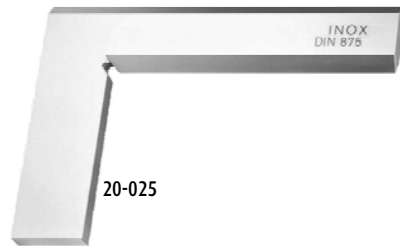

20-025

Art.-Nr. Order no.	Abmessung dimensions	EUR
20-023	50x40 mm	17,50
20-024	75x50 mm	19,80
20-025	100x70 mm	23,50
20-026	150x100 mm	39,50
20-027	200x130 mm	54,50
20-028	300x200 mm	98,00

HELIOS-PREISSER Präzisions-Haarwinkel *Precision knife edge squares*

Rostfreier, gehärteter Stahl | DIN 875-1, Toleranzklasse 00 | Standard oder mit starkem und schwachem Schenkel | Made in Germany
stainless hardened steel | DIN 875-1, tolerance class 00 | standard or with thick and thin blade | Made in Germany



HELIOS · PREISSER



47-901-...

47-903-...

Abmessung dimensions	Standard Standard		Starker+schwacher Schenkel Thick and thin blade	
	Art.-Nr. Order no.	EUR	Art.-Nr. Order no.	EUR
50x40 mm	47-901-01	23,50	47-903-01	65,50
75x50 mm	47-901-02	27,50	47-903-02	73,50
100x70 mm	47-901-03	33,50	47-903-03	83,50
150x100 mm	47-901-04	43,00	47-903-04	107,00
200x130 mm	47-901-05	63,50	47-903-05	137,00
300x200 mm	47-901-06	139,00	47-903-06	223,00
500x330 mm	47-901-07	663,00		

verstellbarer Haarwinkel *Adjustable knife edge squares*

rostfreier Stahl | 2 Haarmesskanten | DIN 875-1, Toleranzklasse 0 | Haarlineal 4x4x60 mm | Griff 40x23x10 mm | Aufbewahrungsbox
stainless steel | 2 bevelled edges | DIN 875-1, tolerance class 0 | knife edge 4x4x60 mm | handle 40x23x10 mm | box



Art.-Nr. Order no.	EUR
20-131	98,00

Winkel, Winkelmesser Squares, protractors

Präzisions-Haarlineal *Precision straight edges*

Werkzeugstahl | schwarz brüniert | mit Handwärmeschutz | Geradheit nach DIN 874 | Etui
tool steel | black-oxide finish | with heat-insulated handle | Straightness according to DIN 874 | sleeve



20-157

Art.-Nr. Order no.	Länge Length	EUR	Art.-Nr. Order no.	Länge Length	EUR
20-151	50 mm	9,50	20-158	300 mm	39,50
20-152	75 mm	10,80	20-159	400 mm	54,50
20-153	100 mm	12,90	20-160	500 mm	79,00
20-154	125 mm	14,00	20-161	600 mm	107,00
20-155	150 mm	16,80	20-162	800 mm	257,00
20-156	200 mm	23,50	20-163	1000 mm	298,00
20-157	250 mm	32,50			

Präzisions-Haarlineal rostfrei *Precision straight edges stainless*

rostfreier Stahl | mit Handwärmeschutz | Geradheit nach DIN 874 | Etui
stainless steel | with heat-insulated handle | Straightness according to DIN 874 | sleeve



20-105

Art.-Nr. Order no.	Länge Length	EUR	Art.-Nr. Order no.	Länge Length	EUR
20-100-1	50 mm	11,80	20-106	300 mm	46,00
20-100-2	75 mm	12,60	20-107	400 mm	66,00
20-101	100 mm	14,80	20-108	500 mm	98,00
20-102	125 mm	17,50	20-109	600 mm	139,00
20-103	150 mm	21,00	20-110	800 mm	278,00
20-104	200 mm	25,50	20-111	1000 mm	345,00
20-105	250 mm	39,50			

HELIOS-PREISSER Präzisions-Haarlineal *Precision straight edges*

rostfreier Stahl, gehärtet und fein geschliffen | blendfrei mattiert (bis Länge 600 mm) | DIN 874 | mit Handwärmeschutz
stainless steel, hardened and fine ground | anti-glare matted (up to length 600 mm) | DIN 874 | with heat-insulated handle



Art.-Nr. Order no.	Länge Length	EUR	Art.-Nr. Order no.	Länge Length	EUR
47-711	75 mm	13,20	47-717	400 mm	83,50
47-712	100 mm	15,50	47-718	500 mm	114,00
47-713	125 mm	16,20	47-719	600 mm	219,00
47-714	150 mm	18,40	47-720	750 mm	445,00
47-715	200 mm	21,00	47-721	1000 mm	583,00
47-716	300 mm	46,00			

Holz-Aufbewahrungsbox auf Anfrage!
Wooden box on request!

Winkel, Winkelmesser Squares, protractors

Winkel-Skala 180° Angle scale 180°

Zum Anbringen an Maschinen und Vorrichtungen | Skala 0°-180° | rostfreier Stahl | mattierte Oberfläche | Made in Japan
To be attached onto machines and jigs | Scale 0°-180° | stainless steel | satin finish | Made in Japan



20-292

Art.-Nr. Order no.	Durchmesser Diameter	Dicke Thickness	Ablesung Reading	Genauigkeit Accuracy	EUR
20-290	90 mm	1,2 mm	1°	±20'	7,85
20-291	120 mm	1,5 mm			17,90
20-292	210 mm	2,0 mm	0,5°	±15'	88,50
20-294	320 mm	2,5 mm			146,00

Winkel-Skala 360° Angle scale 360°

Zum Anbringen an Maschinen und Vorrichtungen | Skala 0°-360° | rostfreier Stahl | mattierte Oberfläche | Made in Japan
To be attached onto machines and jigs | Scale 0°-360° | stainless steel | satin finish | Made in Japan

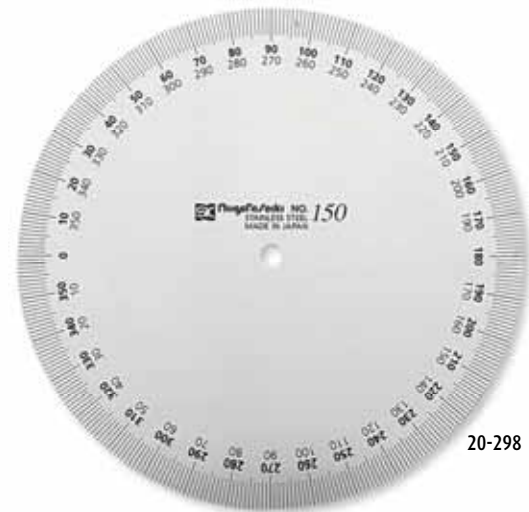

20-298

Art.-Nr. Order no.	Durchmesser Diameter	Dicke Thickness	Ablesung Reading	Genauigkeit Accuracy	EUR
20-295	90 mm	1,2 mm	1°	±20'	18,80
20-296	120 mm	1,5 mm			27,90
20-298	200 mm	2,0 mm			62,50
20-299	300 mm	2,5 mm			113,00

HELIOS-PREISSER Stellwinkel/Schmiege Bevel

zum Abnehmen, Anreißen und Einstellen von individuellen Winkeln | Spezialstahl, verzinkt | Schraubcharnier
for dropping, scribing and adjusting of individual angles | Special steel, zinc coated | screw hinge



HELIOS · PREISSER

Art.-Nr. Order no.	Schenkellänge Leg length	Querschnitt Cross section	EUR
46-711	200 mm	20x8 mm	9,50
46-713	300 mm	25x8 mm	14,50
46-715	500 mm		20,50

Winkel, Winkelmesser

Squares, protractors

Gradmesser Protractor



20-263

verchromter Stahl | Kreisteilung 0°-180° | Feststellschraube | Kunstledertasche
satin chrome finished steel | Range 0°-180° | fixing screw | synthetic leather bag

Art.-Nr. Order no.	Größe (ØxLänge) dimensions (ØxLength)	EUR
20-261	80x120 mm	11,50
20-262	120x150 mm	16,80
20-263	150x200 mm	21,00
20-264	200x300 mm	28,50
20-265	250x500 mm	53,50
20-266	300x600 mm	76,00
20-267	400x800 mm	111,00
20-268	400x1000 mm	132,00

Gradmesser mit verstellbarer Schiene Protractor with adjustable blade



20-272

verchromter Stahl | Kreisteilung 10°-170° | Feststellschraube | Kunstledertasche
satin chrome finished steel | Range 10°-170° | fixing screw | synthetic leather bag

Art.-Nr. Order no.	Größe (ØxLänge) dimensions (ØxLength)	EUR
20-271	100x150 mm	24,50
20-272	150x300 mm	28,00
20-273	200x400 mm	34,00
20-274	250x500 mm	48,00
20-275	300x600 mm	59,50

HELIOS-PREISSER Gradmesser Protractor

Spezialstahl | Kreisteilung 0°-180° | Feststellschraube | Made in Germany
Special steel | Range 0°-180° | fixing screw | Made in Germany



Art.-Nr. Order no.	Größe (ØxLänge) dimensions (ØxLength)	EUR	Art.-Nr. Order no.	Größe (ØxLänge) dimensions (ØxLength)	EUR
46-700	80x120 mm	22,00	46-705	300x600 mm	81,00
46-701	120x150 mm	27,50	46-706	300x800 mm	106,00
46-702	150x200 mm	34,50	46-707	400x600 mm	138,00
46-703	200x300 mm	46,00	46-708	400x800 mm	145,00
46-704	300x500 mm	69,50	46-709	400x1000 mm	151,00

HELIOS-PREISSER Gradmesser mit verstellbarer Schiene Protractor with adjustable blade

Spezialstahl, mattverchromter Gradbogen | Kreisteilung 10°-170° | Feststellschraube
Special steel, satin chrome finished scale | Range 10°-170° | fixing screw



Art.-Nr. Order no.	Größe (ØxLänge) dimensions (ØxLength)	EUR
46-721	100x150 mm	63,50
46-722	150x300 mm	99,00
46-723	200x400 mm	135,00
46-724	250x500 mm	184,00
46-725	300x600 mm	209,00

Winkel, Winkelmesser

Squares, protractors

Innenwinkel-Gradmesser *Inside Protractor*

Messbereich 10°-90° | Ablesung 1° | Genauigkeit 0,5° | rostfreier Stahl | mattierte Oberfläche | Abmessungen 70x70 mm | Aufbewahrungsbox | Made in Japan

Range 10°-90° | Reading 1° | Accuracy 0.5° | stainless steel | matte finish | Dimensions 70x70 mm | plastic case | Made in Japan

Art.-Nr. Order no.	EUR
20-287	149,00



Anwendungsbeispiel:
Example of use:

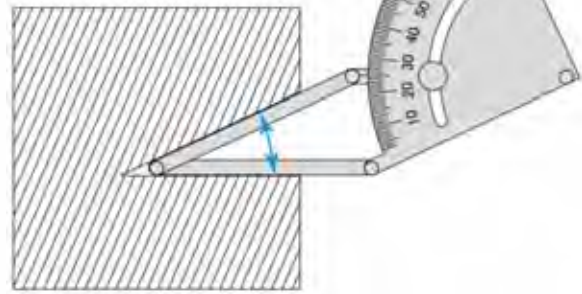

Universal-Gradmesser *Universal Protractor*

Verschiedene Anwendungsmöglichkeiten | Messbereich 0°-180° | Ablesung 1° | Genauigkeit 0,5° | rostfreier Stahl | mattierte Oberfläche | Aufbewahrungsbox | Made in Japan

Different possibilities of use | Range 0°-180° | Reading 1° | Accuracy 0.5° | stainless steel | matte finish | plastic case | Made in Japan



Art.-Nr. Order no.	EUR
20-285	118,00

Abmessungen:
Dimensions:

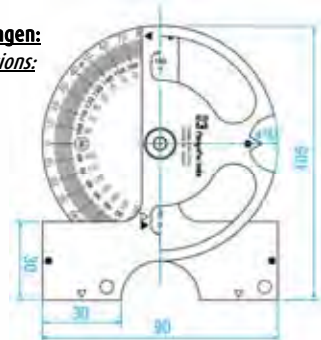

Anwendungsbeispiele:
Examples of use:

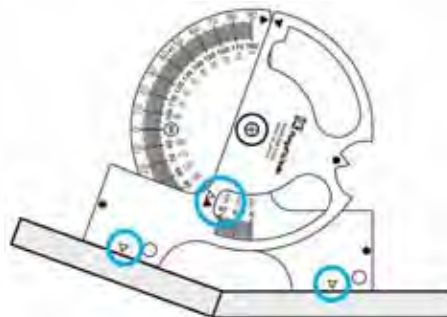
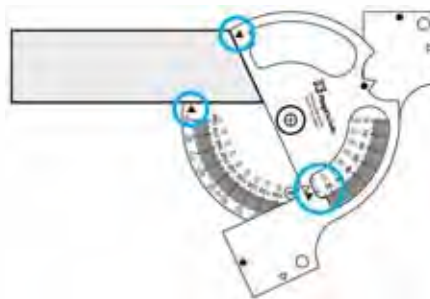
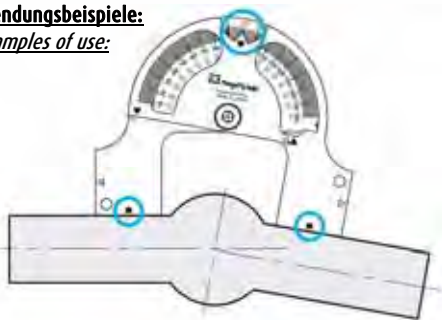

- 01
- 02
- 03
- 04
- 05
- 06
- 07
- 08
- 09
- 10
- 11
- 12
- 13
- 14
- 15

Winkel, Winkelmesser Squares, protractors

Winkelmesser mit Lupe *Protractor with loupe*

rostfreier Stahl | Ablese­teile mattverchromt | Kreisteilung 4x90° | Ablesung 1/12°=5' | Genauigkeit 10' | Feststellschraube | Feineinstellung | parallaxfreie Ablesung | mit 2 auswechselbaren Schienen | Aufbewahrungsbox
stainless steel | satin chrome finished | Range 4x90° | Reading 1/12°=5' | accuracy 10' | fixing screw | fine adjustment | parallax-free | with 2 changeable blades | box



Art.-Nr. Order no.	Schienenlänge Length of blade	EUR
20-259	150/300 mm	74,50

Winkelmesser mit Feinzeiger *Protractor with dial indicator*

rostfreier Stahl | Ablesung 1/12°=5' | Genauigkeit 10' | Feineinstellung | mit 2 auswechselbaren Schienen | Aufbewahrungsbox
stainless steel | Reading 1/12°=5' | accuracy 10' | fine adjustment | with 2 changeable blades | box



Art.-Nr. Order no.	Schienenlänge Length of blade	EUR
20-249	150/300 mm	96,00

HELIOS-PREISSER Winkelmesser mit Lupe *Protractor with loupe*

rostfreier Stahl | Ablese­teile mattverchromt | Kreisteilung 4x90° | Ablesung 1/12°=5' | Feststellschraube | Feineinstellung | parallaxfreie Ablesung | Made in Germany | Aufbewahrungsbox
stainless steel | satin chrome finished | Range 4x90° | Reading 1/12°=5' | fixing screw | fine adjustment | parallax-free | Made in Germany | box



Art.-Nr. Order no.	Schienenlänge Length of blade	EUR
46-731	150 mm	148,00

Digital-Winkel­messer mit Lineal *Digital Protractor with ruler*

Auflösung 0,1° | Messbereich 0-360° | Genauigkeit 0,3° | Lineal-Teilung 1 mm / 1/32" | 0-Stellung an jeder Position möglich
Reading 0.1° | Range 0-360° | Accuracy 0.3° | ruler reading 1 mm / 1/32" | zero setting at any position



Art.-Nr. Order no.	Schenkellänge Length of blade	EUR
20-281	200 mm	32,50
20-282	300 mm	36,50

Winkel, Winkelmesser Squares, protractors

VOGEL Digital-Gradmesser *Digital Protractor*

Auflösung 0,05° | Messbereich 0-180° | Genauigkeit 0,3° | große LCD-Anzeige (Ziffernhöhe 10 mm) | 0-Stellung an jeder Position möglich | mit Feststellschraube | Aufbewahrungsbox

Reading 0.05° | Range 0-180° | Accuracy 0.3° | large LCD display (height of digits 10 mm) | zero setting at any position | with set screw | box



44-291



44-293

Art.-Nr. Order no.	Abmessungen Dimensions	EUR
44-291	Ø120x150 mm	52,50
44-293	Ø200x300 mm	64,50

Digital-Winkelmesser *Digital Protractor*

Auflösung 10'' (10 Winkelsekunden) / 0,005° | Messbereich ±360° | Genauigkeit ±4' | rostfreier Stahl | Messschiene 150/300 mm | Aufbewahrungsbox

Reading 10'' (10 angular seconds) / 0.005° | Range ±360° | Accuracy ±4' | stainless steel | base ruler 150/300 mm | box



Art.-Nr. Order no.	EUR
20-232	318,00

HELIOS-PREISSER Digital-Winkelmesser mit Datenausgang *Digital Protractor with data output*

Auflösung 1' (1 Winkelminute) / 0,01° | Messbereich umschaltbar 1 x 360° / 2 x 180° / 4 x 90° | rostfreier Stahl | Klemmeinrichtung | Datenausgang Opto RS 232 | Aufbewahrungsbox

Reading 1' (1 angular minute) / 0.01° | Range switchable 1 x 360° / 2 x 180° / 4 x 90° | stainless steel | clamping unit | data output opto RS 232 | box



46-741

Art.-Nr. Order no.	Schiene Länge Length of blade	EUR
46-741	150 mm	1290,00
46-742	200 mm	1300,00
46-743	300 mm	1310,00

Informationen und Zubehör zum Thema Datenübertragung finden Sie in Kapitel 15!
Information and accessories related to data transfer can be found in chapter 15!

Winkel, Winkelmesser

Squares, protractors

Neigungsmessgerät *Inclinometer*

Messbereich 0-90° | Ablesung 1° | Genauigkeit 0,5° | Kunststoffgehäuse | mit Magnetfuß | Abmessungen 95x95x30 mm
Range 0-90° | Reading 1° | Accuracy 0.5° | Plastics housing | with magnetic base | Dimensions 95x95x30 mm

Art.-Nr. Order no.	Magnetkraft Magnet force	EUR
20-401	10 N	23,80
20-402	40 N	37,80



Anwendungsbeispiel:
Example of use:



Digital-Neigungsmessgerät *Digital inclinometer*



Auflösung 0,1° | Genauigkeit 0,2° (bis 15°) / 0,5° (15°-90°) | Absolut-Modus (Null bei Horizontal-Position) und Relativ-Modus (Abnullen an beliebiger Position) | Rahmen aus Aluminium | Länge 151 mm

Reading 0.1° | Accuracy 0.2° (up to 15°) / 0.5° (15°-90°) | Absolute mode (zero at horizontal position) and relative mode (zero at any position) | frame made of aluminum | Length 151 mm

Art.-Nr. Order no.	EUR
20-416	79,00

Digital-Neigungsmessgerät mit Magnet und Wasserwaage *Digital inclinometer with magnet and spirit level*



Auflösung 0,1° | Genauigkeit 0,2° (bis 15°) / 0,5° (15°-90°) | Absolut-Modus (Null bei Horizontal-Position) und Relativ-Modus (Abnullen an beliebiger Position) | Länge 50 mm

Reading 0.1° | Accuracy 0.2° (up to 15°) / 0.5° (15°-90°) | Absolute mode (zero at horizontal position) and relative mode (zero at any position) | Length 50 mm

Art.-Nr. Order no.	EUR
20-411	89,50

Neigungsmessgerät mit Radial-Körner *Inclinometer with centre punch*



Messbereich 0-360° | Ablesung 1° | Genauigkeit 1° | Aluminiumgehäuse | mit magnetischem Stahlfuß | mit Hartmetall-Körnerspitze | für Rundmaterial Ø20-100 mm

Range 0-360° | Reading 1° | Accuracy 1° | Aluminium housing | with magnetic steel base | carbide tipped punch | for round stock Ø20-100 mm

Art.-Nr. Order no.	EUR
20-409	268,00

Anwendungsbeispiele:
Examples of use:

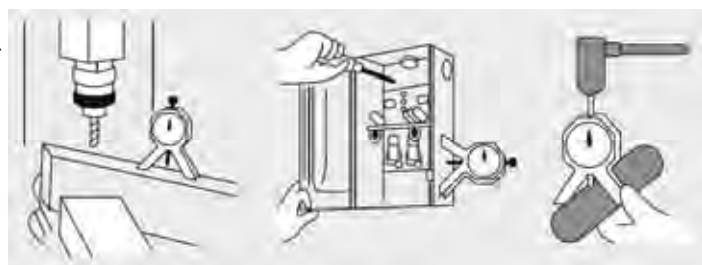

Winkel, Winkelmesser Squares, protractors

VOGEL Präzisions-Wasserwaage Precision bubble level

Längs- und Vertikal-Libelle | Leichtmetall-Rechteckprofil 50x22 mm | Genauigkeit 0,5 mm/m = 0,029° (in Normallage) | Made in Germany
Horizontal and vertical bubble | light metal rectangle profile 50x22 mm | Accuracy 0.5 mm/m = 0.029° (in standard position) | Made in Germany



44-273

Art.-Nr. Order no.	Länge Length	EUR
44-271	300 mm	9,90
44-273	500 mm	12,50
44-275	800 mm	14,00
44-276	1000 mm	16,00

Maschinen-Richtwaage Precision spirit level

Ablesung 0,02 mm/m | prismatische Sohle | Längs- und Querlibelle
Reading 0.02 mm/m | prismatic base | lengthwise and crosswise bubble tube



Art.-Nr. Order no.	Länge Length	EUR
20-451	150 mm	112,00
20-452	300 mm	145,00

HELIOS-PREISSER Maschinen-Richtwaage Precision spirit level

DIN 877 | prismatische Sohle | geschliffene und skalierte Längslibelle | Querlibelle | Made in Germany | Aufbewahrungsbox
DIN 877 | prismatic base | ground lengthwise bubble tube with scale | crosswise bubble tube | Made in Germany | box



46-757

Art.-Nr. Order no.	Ablesung Reading	Länge Length	EUR
46-751	0,3 mm/m	160 mm	149,00
46-753		300 mm	232,00
46-754	0,1 mm/m	160 mm	195,00
46-756		300 mm	277,00
46-757	0,02 mm/m	160 mm	277,00
46-759		300 mm	358,00

HELIOS-PREISSER Rahmen-Richtwaage Precision frame spirit level

DIN 877 | 3 Seiten prismatisch | geschliffene und skalierte Längslibelle | Querlibelle | Made in Germany | Aufbewahrungsbox
DIN 877 | 3 sides prismatic | ground lengthwise bubble tube with scale | crosswise bubble tube | Made in Germany | box



46-767

Art.-Nr. Order no.	Ablesung Reading	Abmessung Dimensions	EUR
46-764	0,1 mm/m	150x150 mm	379,00
46-766		300x300 mm	759,00
46-767	0,02 mm/m	150x150 mm	536,00
46-769		300x300 mm	855,00

Endmaße, Prüfstifte

Gauge blocks, pin gauges



Inhalt Contents



07.2



07.6



07.8



07.9



07.10



07.14



07.16

Normen Standards

Alle unsere Parallelendmaße nach DIN 3650 erfüllen folgende Werte:

All our gauge blocks according to DIN 3650 comply with following values:

Nennmaß (mm) size (mm)	0,5-10	10,5-25	30-50	60-75	80-100	125-150	175-200
Genauigkeit* Toleranzklasse 0 (µm) Accuracy tolerance class 0 (µm)	±0,12	±0,14	±0,2	±0,25	±0,3	±0,4	±0,5
Genauigkeit* Toleranzklasse 1 (µm) Accuracy tolerance class 1 (µm)	±0,2	±0,3	±0,4	±0,5	±0,6	±0,8	±1,0
Genauigkeit* Toleranzklasse 2 (µm) Accuracy tolerance class 2 (µm)	±0,45	±0,6	±0,8	±1,0	±1,2	±1,6	±2,0

*Grenzabmaße der Länge vom Nennmaß an beliebiger Stelle

Weitere Informationen: siehe DIN EN ISO 3650 (DIN Deutsches Institut für Normung e. V., erschienen im Beuth Verlag)
Further information: see DIN EN ISO 3650 (DIN Deutsches Institut für Normung e. V., published by Beuth Verlag)

Kalibrierung Calibration

Informationen zur Kalibrierung erhalten Sie in Kapitel 15!
Information about calibration can be found in chapter 15!

Endmaße, Prüfstifte

Gauge blocks, pin gauges

Einzel-Parallelendmaß Stahl Toleranzklasse 1 *Single gauge block steel tolerance class 1*

Spezialstahl, gehärtet | Genauigkeit nach DIN 3650 Toleranzklasse 1 | Querschnitt bis 10 mm: 30x9 mm, ab 10,5 mm: 35x9 mm |
ab 125 mm mit je 2 Bohrungen für Endmaßverbinder

*special steel, hardened | Accuracy according to DIN 3650 tolerance class 1 | cross section up to 10 mm: 30x9 mm, from 10.5 mm: 35x9 mm |
from 125 mm with 2 holes for gauge connector*



Auszug aus DIN EN ISO 3650 Toleranzklasse 1 *Extract from DIN EN ISO 3650 tolerance class 1*

Nennmaß size (mm)	0,5-10	10,5-25	30-50	60-75	80-100
Genauigkeit* Accuracy (µm)	±0,2	±0,3	±0,4	±0,5	±0,6

*Grenzabmaße der Länge vom Nennmaß an beliebiger Stelle

Art.-Nr. Order no.	Nennmaß size (mm)	EUR	Art.-Nr. Order no.	Nennmaß size (mm)	EUR	Art.-Nr. Order no.	Nennmaß size (mm)	EUR	Art.-Nr. Order no.	Nennmaß size (mm)	EUR
21-201-005	0,5	13,50	21-201-0123	1,23	13,50	21-201-050	5,0	13,50	21-201-240	24,0	13,50
21-201-006	0,6	35,50	21-201-0124	1,24	13,50	21-201-055	5,5	13,50	21-201-245	24,5	13,50
21-201-007	0,7	35,50	21-201-0125	1,25	13,50	21-201-060	6,0	13,50	21-201-250	25	16,50
21-201-008	0,8	35,50	21-201-0126	1,26	13,50	21-201-065	6,5	13,50	21-208-300	30	21,80
21-201-009	0,9	35,50	21-201-0127	1,27	13,50	21-201-070	7,0	13,50	21-208-350	35	33,50
21-201-010	1,0	13,50	21-201-0128	1,28	13,50	21-201-075	7,5	13,50	21-208-400	40	22,90
21-201-010005	1,0005	13,50	21-201-0129	1,29	13,50	21-201-080	8,0	13,50	21-208-413	41,3	27,00
21-201-01001	1,001	13,50	21-201-0130	1,30	13,50	21-201-085	8,5	13,50	21-208-450	45	36,50
21-201-01002	1,002	13,50	21-201-0131	1,31	13,50	21-201-090	9,0	13,50	21-208-500	50	22,90
21-201-01003	1,003	13,50	21-201-0132	1,32	13,50	21-201-095	9,5	13,50	21-208-600	60	27,00
21-201-01004	1,004	13,50	21-201-0133	1,33	13,50	21-201-100	10,0	13,50	21-208-700	70	27,00
21-201-01005	1,005	13,50	21-201-0134	1,34	13,50	21-201-105	10,5	13,50	21-208-750	75	27,00
21-201-01006	1,006	13,50	21-201-0135	1,35	13,50	21-201-110	11,0	13,50	21-210	80	29,50
21-201-01007	1,007	13,50	21-201-0136	1,36	13,50	21-201-115	11,5	13,50	21-211	90	32,50
21-201-01008	1,008	13,50	21-201-0137	1,37	13,50	21-201-120	12,0	13,50	21-212	100	34,50
21-201-01009	1,009	13,50	21-201-0138	1,38	13,50	21-201-125	12,5	13,50	21-213	125	62,00
21-201-0101	1,01	13,50	21-201-0139	1,39	13,50	21-201-130	13,0	13,50	21-306	131,4	129,00
21-201-0102	1,02	13,50	21-201-0140	1,40	13,50	21-201-135	13,5	13,50	21-214	150	83,00
21-201-0103	1,03	13,50	21-201-0141	1,41	13,50	21-201-140	14,0	13,50	21-215	175	98,00
21-201-0104	1,04	13,50	21-201-0142	1,42	13,50	21-201-145	14,5	13,50	21-216	200	111,00
21-201-0105	1,05	13,50	21-201-0143	1,43	13,50	21-201-150	15,0	13,50	21-307	243,5	208,00
21-201-0106	1,06	13,50	21-201-0144	1,44	13,50	21-201-155	15,5	13,50	21-217	250	139,00
21-201-0107	1,07	13,50	21-201-0145	1,45	13,50	21-201-160	16,0	13,50	21-305	281,2	317,00
21-201-0108	1,08	13,50	21-201-0146	1,46	13,50	21-201-165	16,5	13,50	21-218	300	167,00
21-201-0109	1,09	13,50	21-201-0147	1,47	13,50	21-201-170	17,0	13,50	21-219	400	218,00
21-201-0110	1,10	13,50	21-201-0148	1,48	13,50	21-201-175	17,5	13,50	21-304	481,1	324,00
21-201-0111	1,11	13,50	21-201-0149	1,49	13,50	21-201-180	18,0	13,50	21-220	500	281,00
21-201-0112	1,12	13,50	21-201-015	1,5	13,50	21-201-185	18,5	13,50	21-221	600	498,00
21-201-0113	1,13	13,50	21-201-016	1,6	13,50	21-201-190	19,0	13,50	21-222	700	563,00
21-201-0114	1,14	13,50	21-201-017	1,7	13,50	21-201-195	19,5	13,50	21-223	800	664,00
21-201-0115	1,15	13,50	21-201-018	1,8	13,50	21-201-200	20,0	13,50	21-224	900	775,00
21-201-0116	1,16	13,50	21-201-019	1,9	13,50	21-201-205	20,5	13,50	21-225	1000	898,00
21-201-0117	1,17	13,50	21-201-020	2,0	13,50	21-201-210	21,0	13,50			
21-201-0118	1,18	13,50	21-201-025	2,5	13,50	21-201-215	21,5	13,50			
21-201-0119	1,19	13,50	21-201-030	3,0	13,50	21-201-220	22,0	13,50			
21-201-0120	1,20	13,50	21-201-035	3,5	13,50	21-201-225	22,5	13,50			
21-201-0121	1,21	13,50	21-201-040	4,0	13,50	21-201-230	23,0	13,50			
21-201-0122	1,22	13,50	21-201-045	4,5	13,50	21-201-235	23,5	13,50			

Weitere Nennmaße auf Anfrage!

Further sizes on request!

Endmaße, Prüfstifte Gauge blocks, pin gauges

Einzel-Parallelendmaß Stahl Toleranzklasse 0 *Single gauge block steel tolerance class 0*

Spezialstahl, gehärtet | Genauigkeit nach DIN 3650 Toleranzklasse 0 | Querschnitt bis 10 mm: 30x9 mm, ab 10,5 mm: 35x9 mm |
ab 125 mm mit je 2 Bohrungen für Endmaßverbinder

*special steel, hardened | Accuracy according to DIN 3650 tolerance class 0 | cross section up to 10 mm: 30x9 mm, from 10.5 mm: 35x9 mm |
from 125 mm with 2 holes for gauge connector*



Auszug aus DIN EN ISO 3650 Toleranzklasse 0 *Extract from DIN EN ISO 3650 tolerance class 0*

Nennmaß size (mm)	0,5-10	10,5-25	30-50	60-75	80-100
Genauigkeit* Accuracy (µm)	±0,12	±0,14	±0,2	±0,25	±0,3

*Grenzabmaße der Länge vom Nennmaß an beliebiger Stelle

Art.-Nr. Order no.	Nennmaß size (mm)	EUR	Art.-Nr. Order no.	Nennmaß size (mm)	EUR	Art.-Nr. Order no.	Nennmaß size (mm)	EUR	Art.-Nr. Order no.	Nennmaß size (mm)	EUR
21-241-005	0,5	16,50	21-241-0123	1,23	16,50	21-241-050	5,0	16,50	21-241-240	24,0	18,00
21-241-006	0,6	44,00	21-241-0124	1,24	16,50	21-241-055	5,5	16,50	21-241-245	24,5	18,00
21-241-007	0,7	44,00	21-241-0125	1,25	16,50	21-241-060	6,0	16,50	21-241-250	25	18,00
21-241-008	0,8	44,00	21-241-0126	1,26	16,50	21-241-065	6,5	16,50	21-248-300	30	29,50
21-241-009	0,9	44,00	21-241-0127	1,27	16,50	21-241-070	7,0	16,50	21-248-350	35	44,50
21-241-010	1,0	16,50	21-241-0128	1,28	16,50	21-241-075	7,5	16,50	21-248-400	40	29,50
21-241-010005	1,0005	16,50	21-241-0129	1,29	16,50	21-241-080	8,0	16,50	21-248-450	45	46,00
21-241-01001	1,001	16,50	21-241-0130	1,30	16,50	21-241-085	8,5	16,50	21-248-500	50	29,50
21-241-01002	1,002	16,50	21-241-0131	1,31	16,50	21-241-090	9,0	16,50	21-248-600	60	31,50
21-241-01003	1,003	16,50	21-241-0132	1,32	16,50	21-241-095	9,5	16,50	21-248-700	70	31,50
21-241-01004	1,004	16,50	21-241-0133	1,33	16,50	21-241-100	10,0	16,50	21-248-750	75	31,50
21-241-01005	1,005	16,50	21-241-0134	1,34	16,50	21-241-105	10,5	18,00	21-250	80	33,50
21-241-01006	1,006	16,50	21-241-0135	1,35	16,50	21-241-110	11,0	18,00	21-251	90	37,50
21-241-01007	1,007	16,50	21-241-0136	1,36	16,50	21-241-115	11,5	18,00	21-252	100	43,00
21-241-01008	1,008	16,50	21-241-0137	1,37	16,50	21-241-120	12,0	18,00	21-253	125	118,00
21-241-01009	1,009	16,50	21-241-0138	1,38	16,50	21-241-125	12,5	18,00	21-254	150	156,00
21-241-0101	1,01	16,50	21-241-0139	1,39	16,50	21-241-130	13,0	18,00	21-255	175	174,00
21-241-0102	1,02	16,50	21-241-0140	1,40	16,50	21-241-135	13,5	18,00	21-256	200	203,00
21-241-0103	1,03	16,50	21-241-0141	1,41	16,50	21-241-140	14,0	18,00	21-257	250	231,00
21-241-0104	1,04	16,50	21-241-0142	1,42	16,50	21-241-145	14,5	18,00	21-258	300	277,00
21-241-0105	1,05	16,50	21-241-0143	1,43	16,50	21-241-150	15,0	18,00	21-259	400	359,00
21-241-0106	1,06	16,50	21-241-0144	1,44	16,50	21-241-155	15,5	18,00	21-260	500	458,00
21-241-0107	1,07	16,50	21-241-0145	1,45	16,50	21-241-160	16,0	18,00	21-261	600	645,00
21-241-0108	1,08	16,50	21-241-0146	1,46	16,50	21-241-165	16,5	18,00	21-262	700	768,00
21-241-0109	1,09	16,50	21-241-0147	1,47	16,50	21-241-170	17,0	18,00	21-263	800	863,00
21-241-0110	1,10	16,50	21-241-0148	1,48	16,50	21-241-175	17,5	18,00	21-264	900	1174,00
21-241-0111	1,11	16,50	21-241-0149	1,49	16,50	21-241-180	18,0	18,00	21-265	1000	1296,00
21-241-0112	1,12	16,50	21-241-015	1,5	16,50	21-241-185	18,5	18,00			
21-241-0113	1,13	16,50	21-241-016	1,6	16,50	21-241-190	19,0	18,00			
21-241-0114	1,14	16,50	21-241-017	1,7	16,50	21-241-195	19,5	18,00			
21-241-0115	1,15	16,50	21-241-018	1,8	16,50	21-241-200	20,0	18,00			
21-241-0116	1,16	16,50	21-241-019	1,9	16,50	21-241-205	20,5	18,00			
21-241-0117	1,17	16,50	21-241-020	2,0	16,50	21-241-210	21,0	18,00			
21-241-0118	1,18	16,50	21-241-025	2,5	16,50	21-241-215	21,5	18,00			
21-241-0119	1,19	16,50	21-241-030	3,0	16,50	21-241-220	22,0	18,00			
21-241-0120	1,20	16,50	21-241-035	3,5	16,50	21-241-225	22,5	18,00			
21-241-0121	1,21	16,50	21-241-040	4,0	16,50	21-241-230	23,0	18,00			
21-241-0122	1,22	16,50	21-241-045	4,5	16,50	21-241-235	23,5	18,00			

Weitere Nennmaße auf Anfrage!

Further sizes on request!



Endmaße, Prüfstifte

Gauge blocks, pin gauges

Einzel-Parallelendmaß Keramik Toleranzklasse 1 *Single gauge block ceramic tolerance class 1*

Keramik, doppelt so hart wie Stahl, antimagnetisch | Genauigkeit nach DIN 3650 Toleranzklasse 1 | Querschnitt bis 10 mm: 30x9 mm, ab 10,5 mm: 35x9 mm
 ceramic, two times harder than steel, antimagnetic | Accuracy according to DIN 3650 tolerance class 1 | cross section up to 10 mm: 30x9 mm, from 10.5 mm: 35x9 mm



Auszug aus DIN EN ISO 3650 Toleranzklasse 1 *Extract from DIN EN ISO 3650 tolerance class 1*

Nennmaß size (mm)	0,5-10	10,5-25	30-50	60-75	80-100
Genauigkeit* Accuracy (µm)	±0,2	±0,3	±0,4	±0,5	±0,6

*Grenzabmaße der Länge vom Nennmaß an beliebiger Stelle

Art.-Nr. Order no.	Nennmaß size (mm)	EUR	Art.-Nr. Order no.	Nennmaß size (mm)	EUR	Art.-Nr. Order no.	Nennmaß size (mm)	EUR	Art.-Nr. Order no.	Nennmaß size (mm)	EUR
21-271-005	0,5	24,80	21-271-0127	1,27	22,50	21-271-070	7,0	32,50	21-271-400	40	59,00
21-271-010	1,0	22,50	21-271-0128	1,28	22,50	21-271-075	7,5	35,50	21-271-413	41,3	84,50
21-271-010005	1,0005	22,50	21-271-0129	1,29	22,50	21-271-080	8,0	35,50	21-271-500	50	67,00
21-271-010001	1,001	22,50	21-271-0130	1,30	22,50	21-271-085	8,5	35,50	21-271-600	60	69,00
21-271-010002	1,002	22,50	21-271-0131	1,31	22,50	21-271-090	9,0	35,50	21-271-700	70	78,00
21-271-010003	1,003	22,50	21-271-0132	1,32	22,50	21-271-095	9,5	35,50	21-271-750	75	87,00
21-271-010004	1,004	22,50	21-271-0133	1,33	22,50	21-271-100	10,0	35,50	21-271-800	80	94,00
21-271-010005	1,005	22,50	21-271-0134	1,34	22,50	21-271-105	10,5	39,00	21-271-900	90	103,00
21-271-010006	1,006	22,50	21-271-0135	1,35	22,50	21-271-110	11,0	39,00	21-271-1000	100	112,00
21-271-010007	1,007	22,50	21-271-0136	1,36	22,50	21-271-115	11,5	39,00	21-271-1250	125	298,00
21-271-010008	1,008	22,50	21-271-0137	1,37	22,50	21-271-120	12,0	39,00	21-271-1314	131,4	206,00
21-271-010009	1,009	22,50	21-271-0138	1,38	22,50	21-271-125	12,5	39,00	21-271-1500	150	347,00
21-271-0101	1,01	22,50	21-271-0139	1,39	22,50	21-271-130	13,0	39,00			
21-271-0102	1,02	22,50	21-271-0140	1,40	22,50	21-271-135	13,5	39,00			
21-271-0103	1,03	22,50	21-271-0141	1,41	22,50	21-271-140	14,0	39,00			
21-271-0104	1,04	22,50	21-271-0142	1,42	22,50	21-271-145	14,5	39,00			
21-271-0105	1,05	22,50	21-271-0143	1,43	22,50	21-271-150	15,0	39,00			
21-271-0106	1,06	22,50	21-271-0144	1,44	22,50	21-271-155	15,5	39,00			
21-271-0107	1,07	22,50	21-271-0145	1,45	22,50	21-271-160	16,0	39,00			
21-271-0108	1,08	22,50	21-271-0146	1,46	22,50	21-271-165	16,5	39,00			
21-271-0109	1,09	22,50	21-271-0147	1,47	22,50	21-271-170	17,0	39,00			
21-271-0110	1,10	22,50	21-271-0148	1,48	22,50	21-271-175	17,5	39,00			
21-271-0111	1,11	22,50	21-271-0149	1,49	22,50	21-271-180	18,0	39,00			
21-271-0112	1,12	22,50	21-271-015	1,5	24,50	21-271-185	18,5	39,00			
21-271-0113	1,13	22,50	21-271-016	1,6	24,50	21-271-190	19,0	39,00			
21-271-0114	1,14	22,50	21-271-017	1,7	24,50	21-271-195	19,5	39,00			
21-271-0115	1,15	22,50	21-271-018	1,8	24,50	21-271-200	20,0	39,00			
21-271-0116	1,16	22,50	21-271-019	1,9	24,50	21-271-205	20,5	43,50			
21-271-0117	1,17	22,50	21-271-020	2,0	26,80	21-271-210	21,0	43,50			
21-271-0118	1,18	22,50	21-271-025	2,5	26,80	21-271-215	21,5	43,50			
21-271-0119	1,19	22,50	21-271-030	3,0	26,80	21-271-220	22,0	43,50			
21-271-0120	1,20	22,50	21-271-035	3,5	29,50	21-271-225	22,5	43,50			
21-271-0121	1,21	22,50	21-271-040	4,0	29,50	21-271-230	23,0	46,00			
21-271-0122	1,22	22,50	21-271-045	4,5	29,50	21-271-235	23,5	46,00			
21-271-0123	1,23	22,50	21-271-050	5,0	29,50	21-271-240	24,0	46,00			
21-271-0124	1,24	22,50	21-271-055	5,5	32,50	21-271-245	24,5	46,00			
21-271-0125	1,25	22,50	21-271-060	6,0	32,50	21-271-250	25	46,00			
21-271-0126	1,26	22,50	21-271-065	6,5	32,50	21-271-300	30	53,00			

Weitere Nennmaße auf Anfrage!

Further sizes on request!

Endmaße, Prüfstifte

Gauge blocks, pin gauges

Endmaß-Verbinder Gauge block connector



zum Verbinden von Parallelendmaßen ab 125 mm | Lochabstand 50 mm
for connecting gauge blocks from 125 mm | distance between holes 50 mm

Art.-Nr. Order no.	EUR
21-281	77,50

Endmaß-Halter Gauge block holder

zur Nutzung von Endmaßen für präzise Messungen, zum Einstellen von Messgeräten oder zum Anreißen | Fuß (optional) zur senkrechten Nutzung
to use gauge blocks for precise measurements, for setting of measuring tools or for scribing | base (optional) for vertical use



21-282



21-285



21-288

Art.-Nr. Order no.	Maß size	EUR
21-282	0-50 mm	44,50
21-283	0-100 mm	49,50
21-284	100-200 mm	75,00
21-285	200-300 mm	84,00
21-286	300-400 mm	92,00
21-287	400-500 mm	109,00

Fuß base:

Art.-Nr. Order no.	EUR
21-288	127,00

Zubehör für Endmaß-Halter Accessories for gauge block holder

zum Einsatz mit Endmaß-Halter 21-282 bis 21-287
for use with gauge block holder 21-282 to 21-287



21-290-1



21-290-2



21-290-4



21-290-5



21-290-8

Art.-Nr. Order no.	Typ type	Anzahl pieces	Spitze point	Abmessung dimension	EUR
21-290-1	Messschnabel Jaw	2	R2,5x10 mm	40x9x8 mm	73,50
21-290-2	Messschnabel Jaw	2	R5x15 mm	45x9x8 mm	73,50
21-290-4	Anreißspitze Scriber	1		43x9x8 mm	42,50
21-290-5	Zentrierspitze Center point	1	Ø8x8 mm	45x9x8 mm	66,50
21-290-8	Planschenkel Parallel jaw	2		75x9x15 mm	47,00

Endmaß-Halter-Satz mit Zubehör Set of gauge block holders with accessories

12tlg. Satz, bestehend aus 3 Endmaßhaltern (0-50/0-100/100-200 mm), je 2 Messschnäbeln (R2x10/R5x15/R10x40 mm), 1 Anreißspitze, 1 Zentrierspitze und 1 Fuß | Aufbewahrungskoffer



Set of 12 pieces consisting of
3 gauge block holders (0-50/0-100/100-200 mm),
2 jaws in each case (R2x10/R5x15/R10x40 mm), 1 scriber,
1 center point and 1 base | box

Art.-Nr. Order no.	EUR
21-289	654,00

Endmaße, Prüfstifte Gauge blocks, pin gauges

Parallelendmaß-Sätze **Stahl** Gauge block sets steel

Genauigkeit nach DIN 3650 | aus Spezialstahl | inkl. Hersteller-Zertifikat | im Holzkasten
Accuracy according to DIN 3650 | from special steel | incl. manufacturers certificate | in wooden box



21-011



Informationen zu den Toleranzklassen finden Sie auf Seite 07.1!
Information about tolerance classes can be found on page 07.1!

Art.-Nr. Order no.	Toleranz- klasse tolerance class	Anzahl Endmaße number of gauge blocks	Größen (mm) sizes (mm)		EUR
21-001	0	32	1x 1,005	9x 1,01-1,09	286,00
21-002	1		9x 1,10-1,90	9x 1-9	174,00
21-003	2		10/20/30/50		113,00
21-011	0	47	1x 1,005	20x 1,01-1,20	398,00
21-012	1		7x 1,30-1,90	9x 1-9	262,00
21-013	2		10x 10-100		167,00
21-021	0	87	9x 1,001-1,009	49x 1,01-1,49	614,00
21-022	1		19x 0,5-9,5	10x 10-100	395,00
21-023	2				251,00
21-031	0	112	1x 1,0005	9x 1,001-1,009	945,00
21-032	1		49x 1,01-1,49	49x 0,5-24,5	604,00
21-033	2		4x 25-100		393,00
21-051	0	8	125/150/175/200/250/300/400/500		1445,00
21-052	1				856,00
21-053	2				624,00

Weitere Satzzusammenstellungen auf Anfrage!
Further sets on request!

Parallelendmaß-Sätze **Hartmetall** Gauge block sets ceramic

Genauigkeit nach DIN 3650 | inkl. Hersteller-Zertifikat | im Holzkasten
Accuracy according to DIN 3650 | incl. manufacturers certificate | in wooden box



21-091

Weitere Satzzusammenstellungen auf Anfrage!
Further sets on request!

Art.-Nr. Order no.	Toleranz- klasse tolerance class	Anzahl Endmaße number of gauge blocks	Größen (mm) sizes (mm)		EUR
21-081	0	32	1x 1,005	9x 1,01-1,09	695,00
21-082	1		9x 1,10-1,90	9x 1-9	569,00
			10/20/30/50		
21-091	0	47	1x 1,005	20x 1,01-1,20	1285,00
21-092	1		7x 1,30-1,90	9x 1-9	1120,00
			10x 10-100		

Parallelendmaß-Sätze **Keramik** Gauge block sets ceramic

Genauigkeit nach DIN 3650 | inkl. Hersteller-Zertifikat | im Holzkasten
Accuracy according to DIN 3650 | incl. manufacturers certificate | in wooden box



21-071

Weitere Satzzusammenstellungen auf Anfrage!
Further sets on request!

Art.-Nr. Order no.	Toleranz- klasse tolerance class	Anzahl Endmaße number of gauge blocks	Größen (mm) sizes (mm)		EUR
21-061	0	32	1x 1,005	9x 1,01-1,09	983,00
21-062	1		9x 1,10-1,90	9x 1-9	865,00
			10/20/30/50		
21-071	0	47	1x 1,005	20x 1,01-1,20	1637,00
21-072	1		7x 1,30-1,90	9x 1-9	1355,00
			10x 10-100		

Endmaße, Prüfstifte Gauge blocks, pin gauges

HELIOS-PREISSER Parallelendmaß-Sätze Stahl Gauge block sets steel

Genauigkeit nach DIN 3650 | aus Spezialstahl | im Holzkasten
Accuracy according to DIN 3650 | from special steel | in wooden box

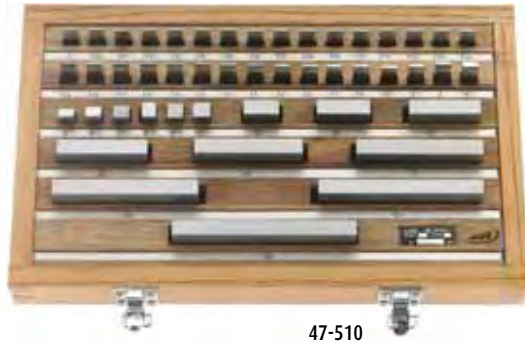

47-510



Informationen zu den Toleranzklassen finden Sie auf Seite 07.1!
Information about tolerance classes can be found on page 07.1!

Art.-Nr. Order no.	Toleranz- klasse tolerance class	Anzahl Endmaße number of gauge blocks	Größen (mm) sizes (mm)		EUR
47-500	0	32	1x 1,005	9x 1,01-1,09	378,00
47-501	1		9x 1,10-1,90	9x 1-9	229,00
47-502	2		10/20/30/50		149,00
47-510	0	47	1x 1,005	20x 1,01-1,20	518,00
47-511	1		7x 1,30-1,90	9x 1-9	316,00
47-512	2		10x 10-100		229,00
47-520	0	87	9x 1,001-1,009	49x 1,01-1,49	796,00
47-521	1		19x 0,5-9,5	10x 10-100	511,00
47-522	2				334,00
47-530	0	103	1x 1,005	49x 1,01-1,49	869,00
47-531	1		49x 0,5-24,5	4x 25-100	669,00
47-532	2				424,00

Winkel-Endmaß-Satz Angle gauge block set

aus Spezialstahl | Länge 76 mm | Dicke 6,35 mm | Genauigkeit $\pm 0,01^\circ$ | 12teilig: $\frac{1}{4}^\circ$, $\frac{1}{2}^\circ$, 1° , 2° , 3° , 4° , 5° , 10° , 15° , 20° , 25° , 30° | Aufbewahrungsbox
from special steel | Length 76 mm | Thickness 6.35 mm | Accuracy $\pm 0.01^\circ$ | 12 pieces: $\frac{1}{4}^\circ$, $\frac{1}{2}^\circ$, 1° , 2° , 3° , 4° , 5° , 10° , 15° , 20° , 25° , 30° | box



Art.-Nr. Order no.	EUR
21-291	67,50

HELIOS-PREISSER Endmaß-Pflege-Set Gauge block maintenance set

6teiliges Set | Holzkasten
set of 6 pieces | wooden box



Inhalt:	Content:
-Leinenlappen	-linen cloth
-Wildledertuch	-buckskin cloth
-Korrosionsschutzöl	-anti-corrosive oil
-Abziehstein	-whetstone
-Haarpinsel	-hair pencil
-Fettpinsel	-fat brush
-Gebrauchsanweisung	-instruction manual

Art.-Nr. Order no.	EUR
47-600	298,00

Endmaße, Prüfstifte Gauge blocks, pin gauges

Einstellmeister für Messschieber *Setting master for calipers*

zum schnellen Überprüfen von Messschiebern: innen $\varnothing 10 \text{ mm} \pm 2 \mu\text{m}$ (zum Prüfen der Messspitzen), außen $\varnothing 30 \text{ mm} \pm 2 \mu\text{m}$ (zum Prüfen der Messschnäbel), Dicke $10 \text{ mm} \pm 10 \mu\text{m}$ (zum Prüfen des Tiefenmaßes)

for quick test of calipers: inside $\varnothing 10 \text{ mm} \pm 2 \mu\text{m}$ (for testing inside measuring points), outside $\varnothing 30 \text{ mm} \pm 2 \mu\text{m}$ (for testing outside measuring jaws), thickness $10 \text{ mm} \pm 10 \mu\text{m}$ (for testing depth measuring rod)



Art.-Nr. Order no.	EUR
21-300	118,00

Prüfsatz für Messschieber *Gauge block set for calibration of calipers*

zum Kalibrieren von Messschiebern | gemäß VDI-Richtlinie VDI/VDE/DGQ 2618 Blatt 9.1 | Genauigkeit DIN 3650 Toleranzklasse 1 | aus Spezialstahl/Keramik | Endmaße inkl. Hersteller-Zertifikat | Sätze im Holzkasten

for calibration of calipers | according to VDI standard VDI/VDE/DGQ 2618 page 9.1 | Accuracy according DIN 3650 tolerance class 1 | from special steel/ceramic | gauge blocks incl. manufacturers certificate | sets in wooden box



21-301

Art.-Nr. Order no.	für Messschieber for calipers	Endmaße (mm) gauge blocks (mm)	Einstellringe setting rings	EUR
21-301	≤200 mm	30,0/41,3/131,4 (Stahl steel)	Ø4/Ø25 mm (Stahl steel)	196,00
21-302		30,0/41,3/131,4 (Keramik ceramic)		368,00
21-303	≤300 mm	41,3/131,4/243,5/281,2 (Stahl steel)		313,00
21-208-413		41,3 (Stahl steel)	-	27,00
21-306		131,4 (Stahl steel)	-	129,00
21-307		243,5 (Stahl steel)	-	208,00
21-305		281,2 (Stahl steel)	-	317,00
21-304	≤500 mm*	481,1 (Stahl steel)	-	324,00

*als Ergänzung zu 21-303 as completion of 21-303

Prüfsatz für Bügelmessschrauben *Gauge block set for calibration of micrometers*

zum Kalibrieren von Bügelmessschrauben | Genauigkeit nach DIN 3650 Toleranzklasse 1 | aus Spezialstahl | Endmaße inkl. Hersteller-Zertifikat | im Holzkasten

for calibration of micrometers | Accuracy according to DIN 3650 tolerance class 1 | from special steel | gauge blocks incl. manufacturers certificate | in wooden box



21-319

Art.-Nr. Order no.	Endmaße (mm) gauge blocks (mm)	Planglas planar glass	EUR
21-310	5,1/10,3/15/20,2/25	-	88,50
21-316		Ø30 mm	158,00
21-311	2,5/5,1/7,7/10,3/12,9/15/17,6/20,2/22,8/25	-	137,00
21-312	1,4/2,5/5,1/7,7/10,3/12,9/15/17,6/20,2/22,8/25	-	143,00
21-317		Ø30 mm	211,00
21-313	1,4/2,5/5,1/7,7/10,3/12,9/15/17,6/20,2/22,8/25/50/75/100	-	216,00
21-318		Ø30 mm	275,00
21-314	5,1/10,3/15/20,2/25/50/75/100	-	127,00
21-319		Ø30 mm	189,00



Prüfplaketten finden Sie in Kapitel 15!

Inspection plates can be found in chapter 15!

Endmaße, Prüfstifte Gauge blocks, pin gauges

HELIOS-PREISSER Prüfsatz für Messschieber Gauge block set for calibration of calipers

zum Kalibrieren von Messschiebern | Genauigkeit DIN 3650 Toleranzklasse 1 | aus Spezialstahl |
inkl. Einstellringe Ø4 / Ø25 mm | Holzkasten
for calibration of calipers | Accuracy according DIN 3650 tolerance class 1 | from special steel |
incl. setting rings Ø4 / Ø25 mm | wooden box



47-601

Art.-Nr. Order no.	für Messschieber for calipers	Endmaße (mm) gauge blocks (mm)	EUR
47-601	≤200 mm	30,0/41,3/131,4	549,00
47-602	≤300 mm	30,0/41,3/131,4/243,5	735,00
47-603	≤500 mm	30,0/41,3/131,4/243,5/281,2/481,1	1315,00
47-604	≤1000 mm	131,4/243,5/281,2/481,1/900	2325,00

HELIOS-PREISSER Prüfsatz für Bügelmessschrauben Gauge block set for calibration of micrometers

zum Kalibrieren von Bügelmessschrauben | Genauigkeit DIN 3650 Toleranzklasse 1 | aus Spezialstahl | Holzkasten
for calibration of micrometers | Accuracy according DIN 3650 tolerance class 1 | from special steel | wooden box



47-608

Art.-Nr. Order no.	Endmaße (mm) gauge blocks (mm)	Planglas planar glass	EUR
47-606	5,1/10,3/15/20,2/25	mit with	332,00
47-607	5,1/10,3/15/20,2/25/50/75/100		444,00
47-608	2,5/5,1/7,7/10,3/12,9/15/17,6/20,2/22,8/25	ohne without	269,00

Planglas Planar glass

zur Prüfung der Ebenheit einer Fläche | Ebenheit 0,1 µm | Aufbewahrungsbox
for inspection of flatness | flatness 0.1 µm | box



21-403

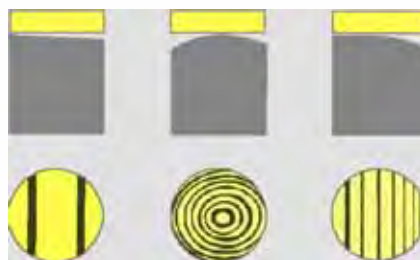

Anwendungsbeispiele: Interferenzstreifenabstand entspricht jeweils ca. 0,27 µm Ebenheitsdifferenz
Examples of use: Distance between interference fringes correlates with ca. 0.27 µm flatness deviation

Art.-Nr. Order no.	Durchmesser diameter	Dicke thickness	EUR
21-401	Ø30 mm	10 mm	74,50
21-402	Ø45 mm	15 mm	96,50
21-403	Ø60 mm		114,00

NIKON Planglas Optical Flat

zur Prüfung der Ebenheit einer Fläche | Ebenheit 0,1 µm | Holz-Aufbewahrungsbox
for inspection of flatness | flatness 0.1 µm | wooden box



Art.-Nr. Order no.	Durchmesser diameter	Dicke thickness	EUR
75-901	Ø60 mm	15 mm	990,00
75-902	Ø130 mm	27 mm	2685,00

Endmaße, Prüfstifte Gauge blocks, pin gauges

Einzel-Prüfstifte $\pm 2 \mu\text{m}$ Single pin gauges $\pm 2 \mu\text{m}$

Genauigkeit $\pm 2 \mu\text{m}$ | aus gehärtetem Spezialstahl, HRC 62 | Stufung 0,01 mm | Länge 50 mm | einzeln in Kunststoff-Aufbewahrungsdose
Accuracy $\pm 2 \mu\text{m}$ | from hardened special steel, HRC 62 | stepping 0.01 mm | Length 50 mm | individually in safe-keeping can



21-5-0503

Bestellbeispiele:

Examples for ordering:

$\emptyset 0,89 \text{ mm}$ → Artikel-Nr. Order no. 21-5-0089
 $\emptyset 4,62 \text{ mm}$ → Artikel-Nr. Order no. 21-5-0462
 $\emptyset 13,00 \text{ mm}$ → Artikel-Nr. Order no. 21-5-1300

Prüfstifte $> \emptyset 30 \text{ mm}$ auf Anfrage!

Pin gauges $> \emptyset 30 \text{ mm}$ on request!

Art.-Nr. Order no.	Durchmesser Diameter	EUR
21-5-XXXX	$\emptyset 0,10\text{-}0,19 \text{ mm}$	8,30
21-5-XXXX	$\emptyset 0,20\text{-}0,49 \text{ mm}$	6,90
21-5-XXXX	$\emptyset 0,50\text{-}0,99 \text{ mm}$	5,70
21-5-XXXX	$\emptyset 10,00\text{-}12,99 \text{ mm}$	8,90
21-5-XXXX	$\emptyset 13,00\text{-}14,99 \text{ mm}$	11,20
21-5-XXXX	$\emptyset 15,00\text{-}17,99 \text{ mm}$	14,40
21-5-XXXX	$\emptyset 18,00\text{-}19,99 \text{ mm}$	17,80
21-5-XXXX	$\emptyset 20,00\text{-}22,99 \text{ mm}$	22,00
21-5-XXXX	$\emptyset 23,00\text{-}24,99 \text{ mm}$	23,90
21-5-XXXX	$\emptyset 25,00\text{-}27,99 \text{ mm}$	30,50
21-5-XXXX	$\emptyset 28,00\text{-}30,00 \text{ mm}$	33,80

XXXX = Nennmaß ohne Komma

XXXX = diameter without decimal point

Aufbewahrungsbox*:

Box:*



21-599-1000

Art.-Nr. Order no.	Durchmesserbereich Diameter range	max. Anzahl Prüfstifte max. number of pin gauges	EUR
21-599-1000	$\emptyset 0,10\text{-}10,00 \text{ mm}$	51	16,80
21-599-1300	$\emptyset 10,01\text{-}13,00 \text{ mm}$	72	29,50
21-599-2000	$\emptyset 13,01\text{-}20,00 \text{ mm}$	50	29,50

*nur geeignet für die Prüfstifte 21-5-XXXX !
suitable only for pin gauges 21-5-XXXX !

Einzel-Prüfstifte Stufung 0,001 mm Single pin gauges stepping 0.001 mm

Prüfstifte mit Sonderabmessungen „dreistellig“ | Genauigkeit $\pm 1 \mu\text{m}$ | gehärteter Spezialstahl, HV 720 (bis $\emptyset 2,699 \text{ mm}$) / HV 650 (ab $\emptyset 2,700 \text{ mm}$)
Pin gauges with special dimension „three-digit“ | Accuracy $\pm 1 \mu\text{m}$ | hardened special steel, HV 720 (up to $\emptyset 2.699 \text{ mm}$) / HV 650 (from $\emptyset 2.700 \text{ mm}$)



99-MS-6,933

Art.-Nr. Order no.	Durchmesser Diameter	Länge Length	EUR
99-MS-X,XXX	$\emptyset 0,201\text{-}0,499 \text{ mm}$	40 mm	27,50
99-MS-X,XXX	$\emptyset 0,501\text{-}0,999 \text{ mm}$		19,80
99-MS-X,XXX	$\emptyset 1,001\text{-}9,999 \text{ mm}$	50 mm	19,80

X,XXX = Nennmaß diameter



Bei Bestellung bitte beachten:

- Bestellbeispiel: $\emptyset 5,137 \text{ mm}$ → Artikel-Nr. 99-MS-5,137
- Sonderanfertigung! Vom Rückgaberecht ausgeschlossen! Lieferzeit: ca. 3-4 Wochen
- Weitere Abmessungen auf Anfrage!

Please note the following when ordering:

- Example for ordering: $\emptyset 5.137 \text{ mm}$ → Order no. 99-MS-5,137
- custom-made product! Barred from return! Delivery time: about 3-4 weeks
- further sizes on request!

Endmaße, Prüfstifte

Gauge blocks, pin gauges

VEITH Einzel-Präzisionsprüfstifte $\pm 1 \mu\text{m}$ Single precision pin gauges $\pm 1 \mu\text{m}$

DIN 2269, Toleranzklasse 1 | Genauigkeit $\pm 1 \mu\text{m}$ | aus gehärtetem Spezialstahl | Stufung 0,01 mm | optional mit Griff lieferbar (bis $\varnothing 2,99 \text{ mm}$) | Made in Germany
 DIN 2269, tolerance class 1 | Accuracy $\pm 1 \mu\text{m}$ | from hardened special steel | stepping 0.01 mm | optional with handle ($\leq \varnothing 2.99 \text{ mm}$) | Made in Germany

VEITH



Prüfstift ohne Griff pin gauge without handle				Aufpreis Griff* surcharge for handle*	
Art.-Nr. Order no.	Durchmesser Diameter	Länge Length	EUR	Art.-Nr. Order no.	EUR
21-6-XXXX	$\varnothing 0,10-0,19 \text{ mm}$	40 mm	61,55	21-613	8,90
21-6-XXXX	$\varnothing 0,20-0,29 \text{ mm}$		42,80	21-614	8,90
21-6-XXXX	$\varnothing 0,30-0,49 \text{ mm}$		22,20	21-615	4,90
21-6-XXXX	$\varnothing 0,50-0,99 \text{ mm}$		11,70	21-616	4,90
21-6-XXXX	$\varnothing 1,00-2,99 \text{ mm}$	70 mm	9,90	21-617	4,90
21-6-XXXX	$\varnothing 3,00-5,99 \text{ mm}$		12,60	-	-
21-6-XXXX	$\varnothing 6,00-9,99 \text{ mm}$		16,60	-	-
21-6-XXXX	$\varnothing 10,00-11,99 \text{ mm}$		22,20	-	-
21-6-XXXX	$\varnothing 12,00-13,99 \text{ mm}$		27,30	-	-
21-6-XXXX	$\varnothing 14,00-15,99 \text{ mm}$		35,90	-	-
21-6-XXXX	$\varnothing 16,00-18,99 \text{ mm}$		44,80	-	-
21-6-XXXX	$\varnothing 19,00-20,00 \text{ mm}$		52,80	-	-

XXXX = Nennmaß ohne Komma
 XXXX = diameter without decimal point

Bestellbeispiele:

Examples for ordering:

$\varnothing 0,89$ (ohne Griff without handle) \rightarrow Art.-Nr. Order no. 21-6-0089
 $\varnothing 13,00$ (ohne Griff without handle) \rightarrow Art.-Nr. Order no. 21-6-1300
 $\varnothing 1,14$ (mit Griff with handle) \rightarrow Art.-Nr. Order no. 21-6-0114 und and 21-617

Prüfstifte $> \varnothing 20 \text{ mm}$ auf Anfrage!

Pin gauges $> \varnothing 20 \text{ mm}$ on request!

*nur zusammen mit dem jeweiligen Prüfstift bestellbar! Prüflänge reduziert sich durch den Griff auf 33 mm bzw. 60 mm!

*only available together with particular pin gauge! Test length will be reduced by handle to 33 mm, respectively to 60 mm!

Einzel-Präzisionsprüfstifte $\varnothing 0,05 - \varnothing 0,09 \text{ mm}$ Single precision pin gauges $\varnothing 0.05 - \varnothing 0.09 \text{ mm}$

Genauigkeit $\pm 0,5 \mu\text{m}$ | gehärteter Spezialstahl, HV 720 | optional mit Griff lieferbar (ab $\varnothing 0,07 \text{ mm}$) | Made in Japan
 Accuracy $\pm 0.5 \mu\text{m}$ | hardened special steel, HV 720 | optional with handle (from $\varnothing 0.07 \text{ mm}$) | Made in Japan



	Art.-Nr. Order no.	Durchmesser Diameter	Länge Length	EUR
ohne Griff without handle	21-6-0005	$\varnothing 0,05 \text{ mm}$	5 mm	78,50
	21-6-0006	$\varnothing 0,06 \text{ mm}$	10 mm	34,80
	21-6-0007	$\varnothing 0,07 \text{ mm}$		34,80
	21-6-0008	$\varnothing 0,08 \text{ mm}$		34,80
	21-6-0009	$\varnothing 0,09 \text{ mm}$		34,80
mit Griff with handle	21-6-0007G	$\varnothing 0,07 \text{ mm}$	3 mm*	52,50
	21-6-0008G	$\varnothing 0,08 \text{ mm}$		52,50
	21-6-0009G	$\varnothing 0,09 \text{ mm}$		52,50

*Prüflänge (Gesamtlänge 41 mm)
 gauge length (overall length 41 mm)



Achtung! Diese Prüfstifte sind mit bloßem Auge kaum sichtbar! Sie müssen deshalb mit besonderer Sorgfalt behandelt werden!

Caution! These pin gauges are hardly visible to the naked eye! Handle with care!

Endmaße, Prüfstifte Gauge blocks, pin gauges

Einzel-Präzisionsprüfstifte **rostfrei** *Single precision pin gauges stainless*

DIN 2269, Toleranzklasse 1 | Genauigkeit $\pm 1 \mu\text{m}$ | rostfreier und säurebeständiger Stahl | Stufung 0,01 mm | Made in Germany
DIN 2269, tolerance class 1 | Accuracy $\pm 1 \mu\text{m}$ | stainless and acid resistant steel | stepping 0.01 mm | Made in Germany



Bestellbeispiele:

Examples for ordering:

Ø0,89 → Art.-Nr. Order no. 99-MSR-0,89

Ø11,00 → Art.-Nr. Order no. 99-MSR-11,00

Art.-Nr. Order no.	Durchmesser Diameter	Länge Length	EUR
99-MSR-X,XX	Ø0,50-0,99 mm	40 mm	14,90
99-MSR-X,XX	Ø1,00-2,99 mm	70 mm	12,90
99-MSR-X,XX	Ø3,00-5,99 mm		15,90
99-MSR-X,XX	Ø6,00-9,99 mm		20,90
99-MSR-XX,XX	Ø10,00-12,00 mm		27,90

X,XX = Nennmaß *diameter*

Einzel-Präzisionsprüfstifte **Keramik** *Single precision pin gauges ceramic*

Genauigkeit $\pm 1 \mu\text{m}$ | Zirkonia-Keramik: rostfrei, antimagnetisch, verschleißarm, Längenausdehnungskoeffizient $(9,25 \pm 1,25) \times 10^{-6} / \text{K}$ | Stufung 0,01 mm
Accuracy $\pm 1 \mu\text{m}$ | Zirconia ceramic: stainless, non-magnetic, low-wear, coefficient of thermal expansion $(9.25 \pm 1.25) \times 10^{-6} / \text{K}$ | stepping 0.01 mm



Bestellbeispiele:

Examples for ordering:

Ø0,89 → Art.-Nr. Order no. 99-MSK-0,89

Ø6,00 → Art.-Nr. Order no. 99-MSK-6,00

Lieferzeit ca. 6-8 Wochen

delivery time approx. 6-8 weeks

Art.-Nr. Order no.	Durchmesser Diameter	Länge Length	EUR
99-MSK-X,XX	Ø0,50-0,99 mm	38 mm	47,50
99-MSK-X,XX	Ø1,00-2,99 mm		39,80
99-MSK-X,XX	Ø3,00-4,99 mm	50 mm	43,50
99-MSK-X,XX	Ø5,00-5,99 mm		49,50
99-MSK-X,XX	Ø6,00-6,99 mm		54,00
99-MSK-X,XX	Ø7,00-7,99 mm		58,50
99-MSK-X,XX	Ø8,00-8,99 mm		67,00
99-MSK-X,XX	Ø9,00-9,99 mm		71,50
99-MSK-10,00	Ø10,00 mm		71,50

X,XX = Nennmaß *diameter*

Prüfstifte >Ø10 mm und Durchmesser mit 3 Nachkommastellen auf Anfrage!

Pin gauges >Ø10 mm and diameter with 3 digits on request!

Einzel-Präzisionsprüfstifte **Hartmetall** *Single precision pin gauges carbide metal*

Genauigkeit $\pm 1 \mu\text{m}$ | Hartmetall: Härte 1300 HV, Längenausdehnungskoeffizient $5 \times 10^{-6} / \text{K}$ | Stufung 0,01 mm
Accuracy $\pm 1 \mu\text{m}$ | carbide metal: hardness 1300 HV, coefficient of thermal expansion $5 \times 10^{-6} / \text{K}$ | stepping 0.01 mm



Bestellbeispiele:

Examples for ordering:

Ø0,89 → Art.-Nr. Order no. 99-MSH-0,89

Ø6,00 → Art.-Nr. Order no. 99-MSH-6,00

Lieferzeit ca. 6-8 Wochen

delivery time approx. 6-8 weeks

Art.-Nr. Order no.	Durchmesser Diameter	Länge Length	EUR
99-MSH-X,XX	Ø0,50-0,99 mm	30 mm	53,00
99-MSH-X,XX	Ø1,00-2,99 mm	38 mm	46,00
99-MSH-X,XX	Ø3,00-4,99 mm	50 mm	53,00
99-MSH-X,XX	Ø5,00-5,99 mm		57,00
99-MSH-X,XX	Ø6,00-6,99 mm		61,00
99-MSH-X,XX	Ø7,00-7,99 mm		76,00
99-MSH-X,XX	Ø8,00-8,99 mm		89,00
99-MSH-X,XX	Ø9,00-9,99 mm		114,00
99-MSH-10,00	Ø10,00 mm		114,00

X,XX = Nennmaß *diameter*

Prüfstifte >Ø10 mm und Durchmesser mit 3 Nachkommastellen auf Anfrage!

Pin gauges >Ø10 mm and diameter with 3 digits on request!

Endmaße, Prüfstifte

Gauge blocks, pin gauges

Prüfstifthalter Pin gauge holder

aus Kunststoff | inklusive Gravur (an der Stirnfläche)
 from plastics | incl. engraving (at front surface)



Bei Bestellung ohne Prüfstift, bitte den Durchmesser für die Gravur angeben!
 When ordering without pin gauge please specify diameter for engraving!

Art.-Nr. Order no.	Messbereich Range	EUR
21-550	Ø0,1-1 mm	5,70
21-551	Ø1-2 mm	4,90
21-552	Ø2-4 mm	5,40
21-553	Ø4-6 mm	5,90
21-554	Ø6-8 mm	6,40
21-555	Ø8-10 mm	6,90

aus Aluminium | mit Kunststoff-Spannhülse
 from aluminium | with resin collet



21-723

Art.-Nr. Order no.	Messbereich Range	EUR	Art.-Nr. Order no.	Messbereich Range	EUR	Art.-Nr. Order no.	Messbereich Range	EUR
21-711	Ø0,2-0,5 mm	19,50	21-718	Ø3,5-4,0 mm	19,50	21-725	Ø7,0-7,5 mm	29,00
21-712	Ø0,5-1,0 mm	19,50	21-719	Ø4,0-4,5 mm	19,50	21-726	Ø7,5-8,0 mm	29,00
21-713	Ø1,0-1,5 mm	19,50	21-720	Ø4,5-5,0 mm	19,50	21-727	Ø8,0-8,5 mm	29,00
21-714	Ø1,5-2,0 mm	19,50	21-721	Ø5,0-5,5 mm	22,00	21-728	Ø8,5-9,0 mm	29,00
21-715	Ø2,0-2,5 mm	19,50	21-722	Ø5,5-6,0 mm	22,00	21-729	Ø9,0-9,5 mm	29,00
21-716	Ø2,5-3,0 mm	19,50	21-723	Ø6,0-6,5 mm	22,00	21-730	Ø9,5-10 mm	29,00
21-717	Ø3,0-3,5 mm	19,50	21-724	Ø6,5-7,0 mm	22,00			

Prüfstifthalter mit Gut- und Ausschusseite Pin gauge holder with „GO“ and „NO GO“ side

aus Kunststoff | für zwei Prüfstifte | Ausschusseite rot gekennzeichnet
 from plastics | for two pin gauges | NO GO side marked red



Art.-Nr. Order no.	Messbereich Range	EUR
21-591	Ø1-2 mm	5,90
21-592	Ø2-4 mm	6,90
21-593	Ø4-6 mm	7,90
21-594	Ø6-8 mm	8,90
21-595	Ø8-10 mm	9,90

Metallguss | für zwei Prüfstifte | Ausschusseite rot gekennzeichnet
 cast metal | for two pin gauges | NO GO side marked red



Art.-Nr. Order no.	Messbereich Range	EUR
21-901	Ø1-2 mm	10,90
21-902	Ø2-4,5 mm	12,30
21-903	Ø4,5-7 mm	22,70
21-904	Ø7-9,5 mm	29,90
21-905	Ø9,5-12 mm	34,00

Messing verchromt | für zwei Prüfstifte | Ausschusseite rot gekennzeichnet
 chrome plated brass | for two pin gauges | NO GO side marked red



21-764

Art.-Nr. Order no.	Messbereich Range	EUR	Art.-Nr. Order no.	Messbereich Range	EUR	Art.-Nr. Order no.	Messbereich Range	EUR
21-751	Ø0,2-0,5 mm	13,90	21-758	Ø3,5-4,0 mm	16,50	21-765	Ø7,0-7,5 mm	35,80
21-752	Ø0,5-1,0 mm	13,90	21-759	Ø4,0-4,5 mm	16,50	21-766	Ø7,5-8,0 mm	35,80
21-753	Ø1,0-1,5 mm	13,90	21-760	Ø4,5-5,0 mm	16,50	21-767	Ø8,0-8,5 mm	35,80
21-754	Ø1,5-2,0 mm	13,90	21-761	Ø5,0-5,5 mm	18,50	21-768	Ø8,5-9,0 mm	35,80
21-755	Ø2,0-2,5 mm	13,90	21-762	Ø5,5-6,0 mm	18,50	21-769	Ø9,0-9,5 mm	35,80
21-756	Ø2,5-3,0 mm	13,90	21-763	Ø6,0-6,5 mm	18,50	21-770	Ø9,5-10 mm	35,80
21-757	Ø3,0-3,5 mm	16,50	21-764	Ø6,5-7,0 mm	18,50			

Endmaße, Prüfstifte Gauge blocks, pin gauges

Universal-Prüfstifthalter Ø1 bis Ø13 mm *Universal pin gauge holder Ø1 to Ø13 mm*

aus Metall | universell einsetzbar für Prüfstifte von Ø1 bis Ø13 mm | Kennzeichnung „GO“ und „NOGO“
from metal | all-purpose for pin gauges from Ø1 to Ø13 mm | "GO" and "NOGO" marking

Art.-Nr. Order no.	Messbereich Range	EUR
21-799	Ø1-13 mm	22,80



Prüfstiftsätze *Pin gauge sets*

aus gehärtetem Spezial-Stahl | Länge 50 mm | Aufbewahrungsbox
from hardened special steel | Length 50 mm | box



21-576

Messbereich Range (Ø mm)	Anzahl Prüfstifte number of pin gauges	Stufung stepping (mm)	Genauigkeit Accuracy ±4 µm		Genauigkeit Accuracy ±2 µm	
			Art.-Nr. Order no.	EUR	Art.-Nr. Order no.	EUR
0,20-0,50	31	0,01			21-560	142,00
0,50-1,00	51	0,01	21-501	164,00	21-561	193,00
1,01-2,00	100	0,01	21-511	229,00	21-571	319,00
2,01-3,00	100	0,01	21-512	229,00	21-572	319,00
3,01-4,00	100	0,01	21-513	229,00	21-573	319,00
4,01-5,00	100	0,01	21-514	229,00	21-574	319,00
5,01-6,00	100	0,01	21-515	229,00	21-575	319,00
6,01-7,00	100	0,01	21-516	229,00	21-576	319,00
7,01-8,00	100	0,01	21-517	229,00	21-577	319,00
8,01-9,00	100	0,01	21-518	229,00	21-578	319,00
9,01-10,00	100	0,01	21-519	229,00	21-579	319,00
10,01-11,00	100	0,01	21-520	267,00	21-621	825,00
11,01-12,00	100	0,01	21-521	267,00	21-622	825,00
12,01-13,00	100	0,01	21-522	267,00	21-623	825,00
13,01-14,00	100	0,01	21-523	267,00	21-624	1010,00
14,01-15,00	100	0,01	21-524	267,00	21-625	1010,00
15,01-16,00	100	0,01	21-525	267,00	21-626	1280,00
16,01-17,00	100	0,01			21-627	1280,00
17,01-18,00	100	0,01			21-628	1280,00
18,01-19,00	100	0,01			21-629	1595,00
19,01-20,00	100	0,01			21-630	1595,00
1-20	20	1	21-531	73,50		
0,5-20	40	0,5	21-533	134,00		
1,0-10,0	91	0,1	21-535	204,00		
0,99-9,99	273	0,1	21-541	596,00		
1,00-10,00		0,1				
1,01-10,01		0,1				

Weitere Satzzusammenstellungen auf Anfrage!
Further sets on request!

Endmaße, Prüfstifte

Gauge blocks, pin gauges

VEITH Präzisions-Prüfstiftsätze ±1 µm Precision pin gauge sets

DIN 2269, Toleranzklasse 1 | Genauigkeit ±1 µm | aus gehärtetem Spezial-Stahl | Länge 70 mm (Ø0,50-Ø1,00 mm Länge 40 mm) | Made in Germany | Holzkiste

DIN 2269 tolerance class 1 | Accuracy ±1 µm | from hardened special steel | Length 70 mm (Ø0.50-Ø1.00 mm length 40 mm) | Made in Germany | wooden box

VEITH



21-655

Weitere Satzzusammenstellungen auf Anfrage!
Further sets on request!

Messbereich Range (Ø mm)	Anzahl Prüfstifte number of pin gauges	Stufung stepping (mm)	Art.-Nr. Order no.	EUR
0,50-1,00	51	0,01	21-650	595,00
1,00-2,00	101	0,01	21-651	990,00
2,01-3,00	100	0,01	21-652	980,00
3,01-4,00	100	0,01	21-653	1249,00
4,01-5,00	100	0,01	21-654	1249,00
5,01-6,00	100	0,01	21-655	1249,00
6,01-7,00	100	0,01	21-656	1649,00
7,01-8,00	100	0,01	21-657*	1699,00
8,01-9,00	100	0,01	21-658*	1699,00
9,01-10,00	100	0,01	21-659*	1699,00
1,0-10,0	91	0,1	21-660	1225,00

*verteilt auf 2 Kisten
*distributed with 2 boxes

Gewinde-Prüfstiftsatz Pin gauge set for measuring threads

zur Prüfung des Gewinde-Flankendurchmessers nach der „3-Draht-Methode“ | für metrische Gewinde mit Steigung 0,5-6 mm (60°) und amerikanische Gewinde 3-48 TPI (60°) | 3 Stück je Größe | Länge 70 mm | Genauigkeit 0,004 mm | aus gehärtetem Spezial-Stahl | Aufbewahrungsbox | inkl. Tabelle zur Auswahl des Drahtdurchmessers und zur Berechnung des Flankendurchmessers

for testing of thread pitch diameter according to "3 wire method" | for metric threads with pitch 0.5-6 mm (60°) and American threads 3-48 TPI (60°) | 3 pieces per size | Length 70 mm | Accuracy 0.004 mm | from hardened special steel | box | inkl. table for wire selection and calculation of pitch diameter



Art.-Nr. Order no.	EUR
21-701	64,50

Anwendungsprinzip:
Type of application:

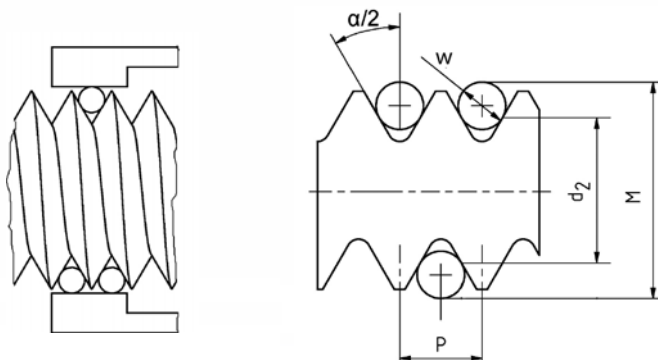

α = Flankenwinkel
P = Gewindesteigung
w = Drahtdurchmesser
M = Messwert (Gewinde mit eingelegten Drähten)
 d_2 = Gewinde-Flankendurchmesser (zu ermitteln)

α = flank angle
P = thread pitch
w = wire diameter
M = measurement (thread with inserted wires)
 d_2 = pitch diameter (to be determined)

Endmaße, Prüfstifte Gauge blocks, pin gauges

Präzisionskugeln *Precision balls*

Genauigkeit $\pm 1,5 \mu\text{m}$ | DIN 5401 | Chromstahl
Accuracy $\pm 1.5 \mu\text{m}$ | DIN 5401 | chrome steel



Art.-Nr. Order no.	Durchmesser Diameter	EUR
29-702	Ø2 mm	9,90
29-703	Ø3 mm	9,90
29-704	Ø4 mm	9,90
29-705	Ø5 mm	9,90
29-706	Ø6 mm	12,50
29-707	Ø7 mm	12,50
29-708	Ø8 mm	12,50
29-709	Ø9 mm	12,50
29-710	Ø10 mm	12,50
29-712	Ø12 mm	19,80
29-715	Ø15 mm	19,80

Messkugel-Satz *Measuring ball set*

Messkugel-Paare Ø1 bis Ø25 mm, Stufung 1 mm | Genauigkeit 0,0025 mm | aus gehärtetem Spezial-Stahl, HRC 60 ± 2 | Aufbewahrungsbox
Pairs of measuring balls Ø1 to Ø25 mm, step 1 mm | accuracy 0.0025 mm | from hardened special steel, HRC 60 ± 2 | box



Art.-Nr. Order no.	EUR
21-705	89,00

Kugel-Lehrdom *biegbar* *Ball plug gauge flexible shaft*

Genauigkeit 0,005 mm | Kugel aus Hartmetall | Schaft aus biegbarem rostfreien Stahl | Schaftlänge 100 mm | beschrifteter Kunststoffgriff | Made in Japan
Accuracy 0.005 mm | ball made from carbide metal | shaft from flexible stainless steel | length of shaft 100 mm | lettered plastics handle | Made in Japan



Art.-Nr. Order no.	Durchmesser Diameter	EUR
29-K-020	Ø2,0 mm	69,50
29-K-025	Ø2,5 mm	59,50
29-K-030	Ø3,0 mm	59,50
29-K-035	Ø3,5 mm	59,50
29-K-040	Ø4,0 mm	59,50
29-K-045	Ø4,5 mm	69,50
29-K-050	Ø5,0 mm	69,50
29-K-055	Ø5,5 mm	74,50
29-K-060	Ø6,0 mm	74,50
29-K-065	Ø6,5 mm	83,50
29-K-070	Ø7,0 mm	83,50

Lehren, Einstellringe

Gauges, setting rings



Inhalt Contents



08.2



08.8



08.9



08.12



08.32



08.33



08.36



08.39

Kalibrierung Calibration

Informationen zur Kalibrierung erhalten Sie in Kapitel 15!
Information about calibration can be found in chapter 15!

Lehren, Einstellringe

Gauges, setting rings

Grenzlehrdorn H7 Limit plug gauge H7

nach DIN 2245 / DIN 7164 | aus Lehrenstahl | Gut- und Ausschußseite
 according to DIN 2245 / DIN 7164 | made of hardened steel | "GO" and "NO GO"



Art.-Nr. Order no.	Nenn- maß size (Ø mm)	EUR	Art.-Nr. Order no.	Nenn- maß size (Ø mm)	EUR	Art.-Nr. Order no.	Nenn- maß size (Ø mm)	EUR	Art.-Nr. Order no.	Nenn- maß size (Ø mm)	EUR
22-001	1	29,50	22-016	16	18,50	22-038	38	31,00	22-065	65	64,00
22-0015	1,5	29,50	22-017	17	18,50	22-039	39	34,00	22-068	68	64,00
22-002	2	17,80	22-018	18	19,50	22-040	40	34,00	22-070	70	72,50
22-0025	2,5	26,00	22-019	19	21,50	22-041	41	39,00	22-072	72	76,50
22-003	3	17,80	22-020	20	21,50	22-042	42	39,00	22-075	75	76,50
22-0035	3,5	23,50	22-021	21	21,50	22-043	43	39,00	22-078	78	79,00
22-004	4	17,80	22-022	22	21,50	22-044	44	39,00	22-080	80	82,00
22-0045	4,5	23,50	22-023	23	21,50	22-045	45	47,50	22-082	82	87,00
22-005	5	17,80	22-024	24	21,50	22-046	46	47,50	22-085	85	92,00
22-0055	5,5	23,50	22-025	25	21,50	22-047	47	47,50	22-088	88	92,00
22-006	6	17,80	22-026	26	25,50	22-048	48	47,50	22-090	90	95,00
22-0065	6,5	28,00	22-027	27	25,50	22-049	49	47,50	22-092	92	99,00
22-007	7	17,80	22-028	28	25,50	22-050	50	47,50	22-095	95	106,00
22-0075	7,5	28,00	22-029	29	25,50	22-052	52	54,50	22-098	98	106,00
22-008	8	17,80	22-030	30	25,50	22-053	53	54,50	22-100	100	106,00
22-009	9	17,80	22-031	31	27,00	22-054	54	54,50	22-105	105	142,00
22-010	10	17,80	22-032	32	27,00	22-055	55	54,50	22-110	110	157,00
22-011	11	17,80	22-033	33	27,00	22-056	56	54,50	22-120	120	178,00
22-012	12	17,80	22-034	34	27,00	22-057	57	54,50	22-125	125	185,00
22-013	13	17,80	22-035	35	31,00	22-058	58	54,50	22-130	130	196,00
22-014	14	17,80	22-036	36	31,00	22-060	60	56,50	22-140	140	219,00
22-015	15	17,80	22-037	37	31,00	22-062	62	56,50	22-150	150	245,00

Weitere Größen auf Anfrage!
 Further sizes on request!



Satz 7teilig Set with 7 gauges
 (Ø3, Ø4, Ø5, Ø6, Ø8, Ø10, Ø12 mm)

Art.-Nr. Order no.	EUR
22-000	121,00



Alle Grenzlehrdorne mit ISO-Toleranz (H7, H8, F7, N6, etc.) werden gemäß DIN 7164 mit Verschleißaufmaß (Abnutzungszugabe) auf der Gut-Seite hergestellt:
 Beispiel Ø15 H7:
 Grenzabmaße Bohrung: 15,000 mm / 15,018 mm
 Lehrenmaße: 15,0025 mm ±1,5 µm / 15,018 mm ±1,5 µm
 Falls Grenzlehrdorne abweichend von DIN 7164 ohne Verschleißaufmaß gewünscht werden, siehe Seite 08.6 (Sonderanfertigung)

All limit plug gauges with ISO tolerances (H7, H8, F7, N6, etc.) are produced with wear oversize according to DIN 7164 (only GO side):

Example Ø15 H7:

Limit deviations hole: 15.000 mm / 15.018 mm

Plug gauge dimensions: 15.0025 mm ±1.5 µm / 15.018 mm ±1.5 µm

If you need limit plug gauges without wear oversize (deviant to DIN 7164), look at page 08.6 (custom-made products)

Lehren, Einstellringe Gauges, setting rings

HELIOS-PREISSER Grenzlehrdorn H7 Made in Germany Limit plug gauge H7

nach DIN 2245 / DIN 7164 | aus Lehrenstahl | Gut- und Ausschußseite | Made in Germany
according to DIN 2245 / DIN 7164 | made of hardened steel | "GO" and "NO GO" | Made in Germany



36-H7-012

Art.-Nr. Order no.	Nenn- maß size (Ø mm)	EUR	Art.-Nr. Order no.	Nenn- maß size (Ø mm)	EUR	Art.-Nr. Order no.	Nenn- maß size (Ø mm)	EUR
36-H7-002	2	29,50	36-H7-024	24	30,50	36-H7-052	52	58,00
36-H7-003	3	22,00	36-H7-025	25	31,50	36-H7-055	55	62,00
36-H7-004	4	19,80	36-H7-026	26	33,00	36-H7-058	58	66,00
36-H7-005	5	18,80	36-H7-027	27	33,00	36-H7-060	60	68,00
36-H7-006	6	18,80	36-H7-028	28	34,00	36-H7-062	62	72,00
36-H7-007	7	19,80	36-H7-030	30	34,00	36-H7-065	65	72,00
36-H7-008	8	19,80	36-H7-032	32	37,50	36-H7-068	68	78,50
36-H7-009	9	21,00	36-H7-033	33	38,50	36-H7-070	70	79,50
36-H7-010	10	22,00	36-H7-034	34	39,50	36-H7-072	72	81,50
36-H7-011	11	22,00	36-H7-035	35	39,50	36-H7-075	75	86,00
36-H7-012	12	23,50	36-H7-036	36	40,50	36-H7-078	78	90,00
36-H7-013	13	24,50	36-H7-037	37	41,00	36-H7-080	80	91,00
36-H7-014	14	24,50	36-H7-038	38	42,50	36-H7-082	82	93,00
36-H7-015	15	25,50	36-H7-040	40	43,50	36-H7-085	85	97,00
36-H7-016	16	25,50	36-H7-042	42	44,50	36-H7-088	88	102,00
36-H7-017	17	26,50	36-H7-043	43	48,50	36-H7-090	90	103,00
36-H7-018	18	27,50	36-H7-044	44	48,50	36-H7-092	92	106,00
36-H7-019	19	27,50	36-H7-045	45	49,00	36-H7-095	95	108,00
36-H7-020	20	27,50	36-H7-046	46	50,00	36-H7-098	98	112,00
36-H7-021	21	29,00	36-H7-047	47	52,00	36-H7-100	100	114,00
36-H7-022	22	29,50	36-H7-048	48	53,00			
36-H7-023	23	30,50	36-H7-050	50	55,00			



Satz 7teilig in Holz-Aufbewahrungsbox
Set with 7 gauges in wooden box
(Ø3, Ø4, Ø5, Ø6, Ø8, Ø10, Ø12 mm)

Art.-Nr. Order no.	EUR
36-H7-999	145,00



Lehren, Einstellringe Gauges, setting rings

Grenzlehndorn H7 hartverchromt *Limit plug gauge H7 hard-chrome plated*

nach DIN 2245 / DIN 7164 | Gutseite hartverchromt | Ausschußseite aus Lehenstahl
according to DIN 2245 / DIN 7164 | "GO" side hard-chrome plated | "NO GO" side made from hardened steel



28-774

Art.-Nr. Order no.	Nenn- maß size (Ø mm)	EUR	Art.-Nr. Order no.	Nenn- maß size (Ø mm)	EUR	Art.-Nr. Order no.	Nenn- maß size (Ø mm)	EUR
28-752	2	89,00	28-762	12	81,00	28-773	23	111,00
28-7525	2,5	89,00	28-763	13	83,00	28-774	24	113,00
28-753	3	77,50	28-764	14	85,00	28-775	25	116,00
28-754	4	71,00	28-765	15	87,00	28-776	26	118,00
28-755	5	64,50	28-766	16	89,00	28-777	27	121,00
28-756	6	64,50	28-767	17	92,00	28-778	28	123,00
28-757	7	68,00	28-768	18	94,00	28-780	30	126,00
28-758	8	71,00	28-769	19	97,00	28-785	35	146,00
28-759	9	73,00	28-770	20	99,00	28-790	40	159,00
28-760	10	76,00	28-771	21	105,00	28-799	50	198,00
28-761	11	78,00	28-772	22	108,00			

Weitere Größen auf Anfrage! Lehdorne mit Gut- und Ausschußseite hartverchromt auf Anfrage!
Further sizes on request! Plug gauge with "GO" and "NOGO" side hard-chrome plated on request!

Grenzlehndorn H7 Hartmetall *Limit plug gauge H7 carbide metal*

nach DIN 2245 / DIN 7164 | Gutseite aus Hartmetall | Ausschußseite aus Lehenstahl
according to DIN 2245 / DIN 7164 | "GO" side made from carbide metal | "NO GO" side made from hardened steel



28-724

Art.-Nr. Order no.	Nenn- maß size (Ø mm)	EUR	Art.-Nr. Order no.	Nenn- maß size (Ø mm)	EUR	Art.-Nr. Order no.	Nenn- maß size (Ø mm)	EUR	Art.-Nr. Order no.	Nenn- maß size (Ø mm)	EUR
28-701	1	74,00	28-707	7	95,00	28-715	15	140,00	28-723	23	178,00
28-7015	1,5	77,50	28-708	8	97,00	28-716	16	144,00	28-724	24	183,00
28-702	2	85,00	28-709	9	107,00	28-717	17	149,00	28-725	25	216,00
28-7025	2,5	86,00	28-710	10	115,00	28-718	18	154,00	28-726	26	221,00
28-703	3	87,00	28-711	11	122,00	28-719	19	159,00	28-727	27	231,00
28-704	4	88,00	28-712	12	124,00	28-720	20	163,00	28-728	28	236,00
28-705	5	89,00	28-713	13	131,00	28-721	21	167,00	28-729	29	244,00
28-706	6	93,00	28-714	14	135,00	28-722	22	172,00	28-730	30	253,00

Weitere Größen auf Anfrage! Lehdorne mit Gut- und Ausschußseite aus Hartmetall auf Anfrage!
Further sizes on request! Plug gauge with "GO" and "NOGO" side made from carbide metal on request!

Lehren, Einstellringe

Gauges, setting rings

Grenzlehndorn sonstige Passungen *Limit plug gauge other fittings*

nach DIN 2245 / DIN 7164 | aus Lehrenstahl | Gut- und Ausschußseite
 according to DIN 2245 / DIN 7164 | made of hardened steel | "GO" and "NO GO"



28-7-20-H8

Nennmaß size (Ø mm)	EUR														
	Passung Fitting														
	H6	H8	H9	H11	D10	E9	F7	F8	G7	J7	K6	K7	N7	P7	R7
2	39,50	39,50	39,50	39,50	39,50	39,50	39,50	39,50	39,50	39,50	39,50	39,50	39,50	39,50	39,50
3	32,80	32,80	32,80	32,80	32,80	32,80	32,80	32,80	32,80	32,80	32,80	32,80	32,80	32,80	32,80
4	32,80	32,80	32,80	32,80	32,80	32,80	32,80	32,80	32,80	32,80	32,80	32,80	32,80	32,80	32,80
5	32,80	32,80	32,80	32,80	32,80	32,80	32,80	32,80	32,80	32,80	32,80	32,80	32,80	32,80	32,80
6	32,80	32,80	32,80	32,80	32,80	32,80	32,80	32,80	32,80	32,80	32,80	32,80	32,80	32,80	32,80
7	32,80	32,80	32,80	32,80	32,80	32,80	32,80	32,80	32,80	32,80	32,80	32,80	32,80	32,80	32,80
8	32,80	32,80	32,80	32,80	32,80	32,80	32,80	32,80	32,80	32,80	32,80	32,80	32,80	32,80	32,80
9	32,80	32,80	32,80	32,80	32,80	32,80	32,80	32,80	32,80	32,80	32,80	32,80	32,80	32,80	32,80
10	32,80	32,80	32,80	32,80	32,80	32,80	32,80	32,80	32,80	32,80	32,80	32,80	32,80	32,80	32,80
11	32,80	32,80	32,80	32,80											
12	34,50	34,50	34,50	34,50	34,50	34,50	34,50	34,50	34,50	34,50	34,50	34,50	34,50	34,50	34,50
13	34,50	34,50	34,50	34,50											
14	37,00	37,00	37,00	37,00			39,50	39,50							
15	37,00	37,00	37,00	37,00			42,50	42,50							
16	39,50	39,50	39,50	39,50			42,50	42,50							
17	39,50	39,50	39,50	39,50											
18	42,00	42,00	42,00	42,00			42,50	42,50							
19	42,00	42,00	42,00	42,00											
20	42,00	42,00	42,00	42,00			46,50	46,50							
21	46,50	46,50	46,50												
22	46,50	46,50	46,50												
23	46,50	46,50	46,50												
24	46,50	46,50	46,50												
25	49,50	49,50	49,50												
26	49,50	49,50													
27	49,50	49,50													
28	49,50	49,50													
30	49,50	49,50													
32	67,50	67,50													
33	67,50	67,50													
35	67,50	67,50													
37	72,50	72,50													
38	72,50	72,50													
40	72,50	72,50													
42	86,00	86,00													
45	94,00	94,00													
50	94,00	94,00													

Bei Bestellung: **Art.-Nr. 28-7-„Nennmaß“-„Passung“** (z. B. 28-7-5-F7 für Grenzlehndorn Ø5 F7 / 28-7-18-H11 für Grenzlehndorn Ø18 H11)
 When ordering: **Order No. 28-7-„size“-„fitting“** (e. g. 28-7-5-F7 for limit plug gauge Ø5 F7 / 28-7-18-H11 for limit plug gauge Ø18 H11)

Weitere Größen und Passungen: siehe nächste Seite!
 Further sizes and fittings: please look at next page!



Lehren, Einstellringe

Gauges, setting rings

Grenzlehrdorn Sonderabmessungen Limit plug gauge customized dimensions

nach DIN 2245 | ISO-Toleranzen nach DIN 7164, Herstellertoleranz bei individuellen Passungen $\pm 2 \mu\text{m}$ | aus Lehnstahl | Gut- und Ausschubseite | eingravierte Bezeichnung (Nennmaß und Toleranz)

according to DIN 2245 | ISO tolerances according to DIN 7164, customized tolerance dimensions $\pm 2 \mu\text{m}$ | made of hardened steel | "GO" and "NO GO" | engraved identification (size and tolerance)



Grenzlehrdorne mit ISO-Toleranz
Limit plug gauges with ISO tolerance
Ø5 N6 / Ø8,2 H7 / Ø16 E7 etc.

Art.-Nr. Order no.	Nennmaß Size (Ø mm)	EUR
28-8-0006	0,400-0,600	109,00
28-8-001	0,601-1,000	84,00
28-8-0015	1,001-1,500	73,00
28-8-002	1,501-2,000	63,00
28-8-003	2,001-3,000	42,50
28-8-006	3,001-6,000	39,50
28-8-010	6,001-10,000	42,50
28-8-014	10,001-14,000	44,50
28-8-018	14,001-18,000	47,00
28-8-024	18,001-24,000	49,50
28-8-030	24,001-30,000	53,50
28-8-035	30,001-35,000	74,00
28-8-040	35,001-40,000	78,50
28-8-044	40,001-44,000	93,00
28-8-050	44,001-50,000	99,00
28-8-060	50,001-60,000	108,00
28-8-068	60,001-68,000	127,00
28-8-070	68,001-70,000	133,00
28-8-076	70,001-76,000	138,00
28-8-087	76,001-87,000	149,00
28-8-090	87,001-90,000	162,00
28-8-099	90,001-100,000	174,00

Grenzlehrdorne mit individuellen Toleranzen
Limit plug gauges with customized tolerance dimensions
Ø5 $\pm 0,1$ / Ø8 -0,01 +0,05 etc.

Art.-Nr. Order no.	Nennmaß Size (Ø mm)	EUR
28-8-Z006	0,400-0,600	113,00
28-8-Z01	0,601-1,000	87,00
28-8-Z015	1,001-1,500	76,50
28-8-Z02	1,501-2,000	66,50
28-8-Z03	2,001-3,000	49,50
28-8-Z06	3,001-6,000	47,50
28-8-Z10	6,001-10,000	49,50
28-8-Z14	10,001-14,000	51,00
28-8-Z18	14,001-18,000	53,50
28-8-Z24	18,001-24,000	57,50
28-8-Z30	24,001-30,000	62,00
28-8-Z35	30,001-35,000	85,00
28-8-Z40	35,001-40,000	89,00
28-8-Z44	40,001-44,000	107,00
28-8-Z50	44,001-50,000	116,00
28-8-Z60	50,001-60,000	124,00
28-8-Z68	60,001-68,000	146,00
28-8-Z70	68,001-70,000	153,00
28-8-Z76	70,001-76,000	159,00
28-8-Z87	76,001-87,000	173,00
28-8-Z90	87,001-90,000	186,00
28-8-Z99	90,001-100,000	199,00



Alle Grenzlehrdorne mit ISO-Toleranz (H7, H8, F7, N6, etc.) werden gemäß DIN 7164 mit Verschleißaufmaß (Abnutzungszugabe) auf der Gut-Seite hergestellt:

Beispiel Ø15 H7:

Grenzabmaße Bohrung: 15,000 mm / 15,018 mm

Lehrenmaße: 15,0025 mm $\pm 1,5 \mu\text{m}$ / 15,018 mm $\pm 1,5 \mu\text{m}$

Falls Grenzlehrdorne abweichend von DIN 7164 ohne Verschleißaufmaß gewünscht werden, bitte bei Bestellung "ohne Verschleißaufmaß" angeben (Sonderanfertigung!)

All limit plug gauges with ISO tolerances (H7, H8, F7, N6, etc.) are produced with wear oversize according to DIN 7164 (only GO side):

Example Ø15 H7:

Limit deviations hole: 15.000 mm / 15.018 mm

Plug gauge dimensions: 15.0025 mm $\pm 1.5 \mu\text{m}$ / 15.018 mm $\pm 1.5 \mu\text{m}$

If you need limit plug gauges without wear oversize (deviant to DIN 7164), please indicate at your order (custom-made product!)

Bei Bestellung bitte beachten:

-Preise nur gültig für Passungen ab ISO-Toleranzgrad 6 (z. B. N6, G8, H13, etc.)! Passungen bis Toleranzgrad 5 (z. B. H5, N4) bitte separat anfragen!

-bitte gewünschte Passung zusätzlich zu Art.-Nr. angeben (z. B. „28-8-018 16E7“ oder „28-8-Z06 5 \pm 0,1“ oder „28-8-Z10 8,0 -0,01/+0,05“)

-Sonderanfertigung! Von Storno- und Rückgaberecht ausgeschlossen! Lieferzeit: ca. 2-3 Wochen

Please note the following when ordering:

-prices valid only for tolerances from ISO-degree 6 (e. g. N6, G8, H13, etc.)! Tolerances up to degree 5 (e. g. H5, N4) upon request!

-please add your desired tolerance to our order no. (e. g. „28-8-018 16E7“ or „28-8-Z06 5 \pm 0.1“ or „28-8-Z10 8,0 -0,01/+0,05“)

-custom-made product! Barred from cancellation and return! Delivery time: about 2-3 weeks

Lehren, Einstellringe Gauges, setting rings

JBO Grenzlehrdorn „MultiCheck“ mit Bohrungstiefe-Prüfung *Limit plug gauge „MultiCheck“ with checking of hole depth*

Prüfung des Bohrungsdurchmessers und der -tiefe mit nur einem Messmittel | Auflösung (Tiefenmessung) 0,01 mm | Digitalanzeige mit integriertem Funkmodul | Messtiefe 4x Durchmesser | Lufrnut | inkl. Hersteller-Kalibrierzertifikat

One single measuring device for checking both - accuracy of hole diameter and depth | Reading (depth measuring) 0.01 mm | Digital display with integrated wireless module | Gauging depth up to 4x diameter | Air groove | Manufacturers calibration certificate included



Anwendungsbeispiel

Example of use



Art.-Nr. Order no.	Nennmaß size (Ø mm)	EUR
48-803	3 H7	729,00
48-804	4 H7	736,00
48-805	5 H7	727,00
48-806	6 H7	719,00
48-807	7 H7	762,00
48-808	8 H7	754,00
48-809	9 H7	756,00
48-810	10 H7	757,00
48-811	11 H7	859,00
48-812	12 H7	879,00
48-813	13 H7	883,00
48-814	14 H7	889,00
48-815	15 H7	899,00
48-816	16 H7	915,00
48-817	17 H7	920,00
48-818	18 H7	925,00
48-819	19 H7	930,00
48-820	20 H7	935,00

*Weitere Größen auf Anfrage!
Further sizes on request!*

Bohrungslehrdorn-Set, einstellbar *Hole gauge set, adjustable*

für Bohrungen und Nuten | 4teiliges Set, einstellbar von Ø3 bis Ø13 mm | Griff mattverchromt

for holes and grooves | set of 4 pieces, adjustable from Ø3 to Ø13 mm | handle satin chrome finished

Art.-Nr. Order no.	EUR
24-019	19,50



Abmessungen: *Dimensions:*

Lehrdorn Gauge	Einstellbereich Range	L (mm)	a (mm)	d (mm)
1	Ø3-5 mm	90	22,5	Ø5,5
2	Ø5-7,5 mm	98	30	Ø5,5
3	Ø7,5-10 mm	103	35	Ø8,5
4	Ø10-13 mm	108	40	Ø8,5

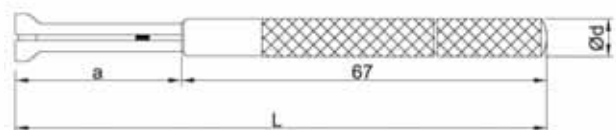

Lehren, Einstellringe Gauges, setting rings

Grensrachenlehre *Caliper gauge*

nach DIN 7150-2 / DIN 7163 | Lehenstahl, gehärtet
according to DIN 7150-2 / DIN 7163 | hardened steel



Art.-Nr. Order no.	Nennmaß size	EUR	Art.-Nr. Order no.	Nennmaß size	EUR
28-501	2-3 mm	115,00	28-510	>38-43 mm	142,00
28-502	>3-6 mm	112,00	28-511	>43-49 mm	152,00
28-503	>6-10 mm	102,00	28-512	>49-56 mm	162,00
28-504	>10-14 mm	107,00	28-513	>56-63 mm	175,00
28-505	>14-18 mm	114,00	28-514	>63-70 mm	192,00
28-506	>18-22 mm	124,00	28-515	>70-77 mm	207,00
28-507	>22-27 mm	126,00	28-516	>77-84 mm	226,00
28-508	>27-32 mm	128,00	28-517	>84-92 mm	232,00
28-509	>32-38 mm	134,00	28-518	>92-100 mm	242,00

Bei Bestellung bitte beachten:

- Preise gültig für Nennmaße mit vollen Millimetern und ISO-Passungen (DIN EN ISO 286) ab Toleranzgrad 6 (z. B. „8 n9“ oder „10 f7“)
- für Zwischenmaße und individuelle Toleranzen berechnen wir 30% Aufschlag (z. B. „9,5 h7“ oder „12 -0,004/+0,016“)
- Sonderanfertigung! Vom Rückgaberecht ausgeschlossen! Lieferzeit: ca. 6 Wochen
- Please note the following when ordering:*
- prices are for sizes with full millimeters and ISO tolerances (DIN EN ISO 286) from ISO degree 6 (e. g. „8 n9“ or „10 f7“)
- for sizes between full millimeters and individual tolerances please add 30% extra charge (e. g. „9.5 h7“ or „12 -0.004/+0.016“)
- custom-made product! Barred from return! Delivery time: about 6 weeks

HELIOS-PREISSER Grensrachenlehre, **verstellbar** *Caliper gauge, adjustable*

Spezialguss | 1 feste Messfläche, 2 verstellbare Vierkantmessflächen | Made in Germany
Special cast iron | 1 solid jaw, 2 adjustable square jaws | Made in Germany



Art.-Nr. Order no.	Nennmaß size	EUR	Art.-Nr. Order no.	Nennmaß size	EUR
46-770	0-6 mm	69,50	46-780	64-70 mm	83,00
46-771	6-13 mm	69,50	46-781	70-78 mm	91,00
46-772	13-19 mm	69,50	46-782	78-87 mm	91,00
46-773	19-26 mm	72,50	46-783	87-97 mm	101,00
46-774	26-32 mm	72,50	46-784	97-106 mm	116,00
46-775	32-38 mm	76,50	46-785	106-116 mm	116,00
46-776	38-44 mm	76,50	46-786	116-125 mm	138,00
46-777	44-51 mm	79,50	46-787	125-135 mm	179,00
46-778	51-57 mm	79,50	46-788	135-144 mm	206,00
46-779	57-64 mm	83,00	46-789	144-156 mm	206,00

Einstellring Setting ring

Genauigkeit nach DIN 2250-C | Lehenstahl, gehärtet | mit eingraviertem Ist-Maß
Accuracy according to DIN 2250-C | hardened steel | with engraved actual size



22-237



Toleranzklasse der Bohrung gemäß DIN 2250-C ist JS4 (DIN EN ISO 286):

Tolerance class of the hole according to DIN 2250-C is JS4 (DIN EN ISO 286):

- ±1,5 µm (≤ Ø3 mm)
- ±2,0 µm (≤ Ø10 mm)
- ±2,5 µm (≤ Ø18 mm)
- ±3,0 µm (≤ Ø30 mm)
- ±3,5 µm (≤ Ø50 mm)
- ±4,0 µm (≤ Ø80 mm)
- ±5,0 µm (≤ Ø120 mm)
- ±6,0 µm (≤ Ø180 mm)
- ±7,0 µm (≤ Ø250 mm)
- ±8,0 µm (≤ Ø315 mm)
- ±9,0 µm (≤ Ø400 mm)

Art.-Nr. Order no.	Nennmaß size (Ø mm)	EUR	Art.-Nr. Order no.	Nennmaß size (Ø mm)	EUR	Art.-Nr. Order no.	Nennmaß size (Ø mm)	EUR
22-203	3	29,50	22-238	38	52,50	22-290	90	118,00
22-2035	3,5	29,50	22-239	39	56,00	22-292	92	122,00
22-204	4	29,50	22-240	40	52,50	22-295	95	122,00
22-2045	4,5	29,50	22-241	41	58,00	22-298	98	122,00
22-205	5	29,50	22-242	42	52,50	22-300	100	129,00
22-206	6	29,50	22-243	43	58,00	22-305	105	186,00
22-207	7	29,50	22-244	44	52,50	22-310	110	197,00
22-208	8	29,50	22-245	45	52,50	22-3125	112,5	223,00
22-209	9	29,50	22-246	46	61,00	22-315	115	197,00
22-210	10	29,50	22-247	47	61,00	22-320	120	227,00
22-211	11	29,50	22-248	48	61,00	22-325	125	238,00
22-212	12	29,50	22-249	49	64,00	22-330	130	255,00
22-213	13	29,50	22-250	50	64,00	22-335	135	266,00
22-214	14	29,50	22-252	52	69,00	22-3375	137,5	278,00
22-215	15	29,50	22-254	54	69,00	22-340	140	278,00
22-216	16	31,00	22-255	55	69,00	22-345	145	295,00
22-217	17	31,00	22-256	56	73,00	22-350	150	298,00
22-218	18	31,00	22-258	58	73,00	22-355	155	337,00
22-219	19	31,00	22-260	60	73,00	22-360	160	343,00
22-220	20	31,00	22-262	62	81,50	22-3625	162,5	432,00
22-221	21	33,00	22-264	64	94,00	22-365	165	394,00
22-222	22	33,00	22-265	65	81,50	22-370	170	412,00
22-223	23	33,00	22-266	66	94,00	22-375	175	446,00
22-224	24	33,00	22-268	68	81,50	22-380	180	453,00
22-225	25	36,00	22-270	70	87,00	22-385	185	499,00
22-226	26	36,00	22-272	72	87,00	22-3875	187,5	528,00
22-227	27	36,00	22-274	74	94,00	22-390	190	508,00
22-228	28	36,00	22-275	75	87,00	22-395	195	542,00
22-229	29	36,00	22-276	76	99,00	22-400	200	549,00
22-230	30	39,50	22-278	78	87,00	22-425	225	718,00
22-231	31	52,00	22-280	80	87,00	22-450	250	793,00
22-232	32	41,50	22-282	82	98,00	22-475	275	909,00
22-233	33	41,50	22-284	84	98,00	22-500	300	1145,00
22-234	34	41,50	22-285	85	108,00	22-525	325	1485,00
22-235	35	41,50	22-286	86	113,00	22-550	350	1530,00
22-236	36	52,50	22-287	87	113,00	22-600	400	1995,00
22-237	37	52,50	22-288	88	113,00			

Gut-Lehrringe (DIN 2250-G) und Ausschusslehrringe (DIN 2254) auf Anfrage!

Einstellringe mit Sonderabmessungen (Zwischenmaße): siehe Folgeseiten!

*GO ring gauges (DIN 2250-G) and NO GO ring gauges (DIN 2254) on request!
Setting rings with customized dimensions: see following pages!*

01

02

03

04

05

06

07

08

09

10

11

12

13

14

15

Lehren, Einstellringe Gauges, setting rings

NIIGATA Präzisions-Einstellring Made in Japan Precision setting ring



37-ER-90

Genauer als DIN 2250-C | Lehrenstahl, gehärtet | mit eingraviertem Nennmaß und Ist-Maß | Made in Japan | inkl. Hersteller-Kalibrierzertifikat

More precise than DIN 2250-C | hardened steel | with engraved nominal size and actual size | Made in Japan | Manufacturers calibration certificate included

Abmessungen:
Dimensions:

Ø Nennmaß size (mm)	1-2,5	2,6-5	5,1-10	10,1-15	15,1-20	21-25	26-32	33-40	41-50	51-100
Ø Toleranz tolerance (µm)	±1,0	±1,0	±1,0	±1,0	±1,0	±1,0	±1,5	±1,5	±1,5	±2,0
Rundheit roundness (µm)	0,5	0,5	0,5	0,5	0,5	0,5	0,8	0,8	0,8	1,0
Dicke thickness (mm)	4	5	8	10	12	14	16	18	20	24

Art.-Nr. Order no.	Nennmaß size (Ø mm)	EUR	Art.-Nr. Order no.	Nennmaß size (Ø mm)	EUR	Art.-Nr. Order no.	Nennmaß size (Ø mm)	EUR	Art.-Nr. Order no.	Nennmaß size (Ø mm)	EUR
37-ER-1	1	98,00	37-ER-4,8	4,8	65,00	37-ER-8,6	8,6	59,50	37-ER-24	24	79,00
37-ER-1,1	1,1	98,00	37-ER-4,9	4,9	65,00	37-ER-8,7	8,7	59,50	37-ER-25	25	79,00
37-ER-1,2	1,2	98,00	37-ER-5	5	65,00	37-ER-8,8	8,8	59,50	37-ER-26	26	79,00
37-ER-1,3	1,3	98,00	37-ER-5,1	5,1	65,00	37-ER-8,9	8,9	59,50	37-ER-27	27	85,00
37-ER-1,4	1,4	98,00	37-ER-5,2	5,2	65,00	37-ER-9	9	59,50	37-ER-28	28	85,00
37-ER-1,5	1,5	98,00	37-ER-5,3	5,3	65,00	37-ER-9,1	9,1	59,50	37-ER-29	29	85,00
37-ER-1,6	1,6	98,00	37-ER-5,4	5,4	65,00	37-ER-9,2	9,2	59,50	37-ER-30	30	85,00
37-ER-1,7	1,7	98,00	37-ER-5,5	5,5	65,00	37-ER-9,3	9,3	59,50	37-ER-31	31	85,00
37-ER-1,8	1,8	98,00	37-ER-5,6	5,6	65,00	37-ER-9,4	9,4	59,50	37-ER-32	32	85,00
37-ER-1,9	1,9	98,00	37-ER-5,7	5,7	65,00	37-ER-9,5	9,5	59,50	37-ER-33	33	96,00
37-ER-2	2	88,00	37-ER-5,8	5,8	65,00	37-ER-9,6	9,6	59,50	37-ER-34	34	96,00
37-ER-2,1	2,1	88,00	37-ER-5,9	5,9	65,00	37-ER-9,7	9,7	59,50	37-ER-35	35	96,00
37-ER-2,2	2,2	88,00	37-ER-6	6	65,00	37-ER-9,8	9,8	59,50	37-ER-36	36	96,00
37-ER-2,3	2,3	88,00	37-ER-6,1	6,1	65,00	37-ER-9,9	9,9	59,50	37-ER-37	37	96,00
37-ER-2,4	2,4	88,00	37-ER-6,2	6,2	65,00	37-ER-10	10	59,50	37-ER-38	38	96,00
37-ER-2,5	2,5	88,00	37-ER-6,3	6,3	65,00	37-ER-10,5	10,5	65,00	37-ER-39	39	96,00
37-ER-2,6	2,6	79,00	37-ER-6,4	6,4	65,00	37-ER-11	11	65,00	37-ER-40	40	96,00
37-ER-2,7	2,7	79,00	37-ER-6,5	6,5	65,00	37-ER-11,5	11,5	65,00	37-ER-41	41	118,00
37-ER-2,8	2,8	79,00	37-ER-6,6	6,6	65,00	37-ER-12	12	65,00	37-ER-42	42	118,00
37-ER-2,9	2,9	79,00	37-ER-6,7	6,7	65,00	37-ER-12,5	12,5	65,00	37-ER-43	43	118,00
37-ER-3	3	69,00	37-ER-6,8	6,8	65,00	37-ER-13	13	65,00	37-ER-44	44	118,00
37-ER-3,1	3,1	69,00	37-ER-6,9	6,9	65,00	37-ER-13,5	13,5	65,00	37-ER-45	45	127,00
37-ER-3,2	3,2	69,00	37-ER-7	7	59,50	37-ER-14	14	65,00	37-ER-46	46	127,00
37-ER-3,3	3,3	69,00	37-ER-7,1	7,1	59,50	37-ER-14,5	14,5	65,00	37-ER-47	47	127,00
37-ER-3,4	3,4	69,00	37-ER-7,2	7,2	59,50	37-ER-15	15	65,00	37-ER-48	48	127,00
37-ER-3,5	3,5	69,00	37-ER-7,3	7,3	59,50	37-ER-15,5	15,5	65,00	37-ER-49	49	127,00
37-ER-3,6	3,6	69,00	37-ER-7,4	7,4	59,50	37-ER-16	16	65,00	37-ER-50	50	127,00
37-ER-3,7	3,7	69,00	37-ER-7,5	7,5	59,50	37-ER-16,5	16,5	72,00	37-ER-55	55	159,00
37-ER-3,8	3,8	69,00	37-ER-7,6	7,6	59,50	37-ER-17	17	72,00	37-ER-60	60	172,00
37-ER-3,9	3,9	69,00	37-ER-7,7	7,7	59,50	37-ER-17,5	17,5	72,00	37-ER-65	65	184,00
37-ER-4	4	65,00	37-ER-7,8	7,8	59,50	37-ER-18	18	72,00	37-ER-70	70	193,00
37-ER-4,1	4,1	65,00	37-ER-7,9	7,9	59,50	37-ER-18,5	18,5	72,00	37-ER-75	75	199,00
37-ER-4,2	4,2	65,00	37-ER-8	8	59,50	37-ER-19	19	72,00	37-ER-80	80	205,00
37-ER-4,3	4,3	65,00	37-ER-8,1	8,1	59,50	37-ER-19,5	19,5	72,00	37-ER-85	85	246,00
37-ER-4,4	4,4	65,00	37-ER-8,2	8,2	59,50	37-ER-20	20	72,00	37-ER-90	90	258,00
37-ER-4,5	4,5	65,00	37-ER-8,3	8,3	59,50	37-ER-21	21	79,00	37-ER-95	95	281,00
37-ER-4,6	4,6	65,00	37-ER-8,4	8,4	59,50	37-ER-22	22	79,00	37-ER-100	100	295,00
37-ER-4,7	4,7	65,00	37-ER-8,5	8,5	59,50	37-ER-23	23	79,00			

Lehren, Einstellringe

Gauges, setting rings

Einstellring Sonderabmessungen (Zwischenmaße) Setting ring customized dimensions

nach DIN 2250-C | Lehrenstahl, gehärtet | mit eingraviertem Ist-Maß
 according to DIN 2250-C | hardened steel | with engraved actual size



28-ER-039 / 37,300



Toleranzklasse der Bohrung gemäß DIN 2250-C ist JS4 (DIN EN ISO 286):

Tolerance class of the hole according to DIN 2250-C is JS4 (DIN EN ISO 286):

- ±1,5 µm (≤ Ø3 mm)
- ±2,0 µm (≤ Ø10 mm)
- ±2,5 µm (≤ Ø18 mm)
- ±3,0 µm (≤ Ø30 mm)
- ±3,5 µm (≤ Ø50 mm)
- ±4,0 µm (≤ Ø80 mm)
- ±5,0 µm (≤ Ø120 mm)
- ±6,0 µm (≤ Ø180 mm)
- ±7,0 µm (≤ Ø250 mm)

Bei Bestellung bitte beachten:

- bitte gewünschtes Nennmaß zusätzlich zu Art.-Nr. angeben (z. B. „28-ER-005 / 5,275“)
- Abweichung des IST-Maßes vom Nennmaß gemäß DIN 2250 möglich!
- Sonderanfertigung! Vom Rückgaberecht ausgeschlossen!
- Lieferzeit: ca. 4 Wochen (bis Ø39,999 mm) / ca. 8 Wochen (ab Ø40,001 mm)

Please note the following when ordering:

- please add your desired size to our order no. (e. g. „28-ER-005 / 5.275“)
- deviation between desired size and actual size according to DIN 2250 possible!
- custom-made product! Barred from return!
- Delivery time: approx. 4 weeks (up to Ø39.999 mm) / approx. 8 weeks (from Ø40.001 mm)

Abmessungen >200 mm auf Anfrage!

Gut-Lehrringe (DIN 2250-G) und Ausschusslehrringe (DIN 2254) auf Anfrage!

Dimensions >200 mm on request!

GO ring gauges (DIN 2250-G) and NO GO ring gauges (DIN 2254) on request!

Keramik-Einstellringe auf Anfrage!

ceramic setting gauges on request!



Art.-Nr. Order no.	Nennmaß size (Ø mm)	EUR
28-ER-001	1,001-1,999	109,00
28-ER-002	2,001-2,999	98,00
28-ER-003	3,001-3,999	74,00
28-ER-005	4,001-5,999	71,50
28-ER-009	6,001-9,999	69,00
28-ER-011	10,001-11,999	71,50
28-ER-014	12,001-14,999	74,00
28-ER-019	15,001-19,999	79,00
28-ER-024	20,001-24,999	85,00
28-ER-031	25,001-31,999	94,00
28-ER-039	32,001-39,999	99,00
28-ER-049	40,001-49,999	103,00
28-ER-059	50,001-59,999	108,00
28-ER-069	60,001-69,999	121,00
28-ER-079	70,001-79,999	132,00
28-ER-089	80,001-89,999	159,00
28-ER-099	90,001-99,999	176,00
28-ER-109	100,001-109,999	197,00
28-ER-119	110,001-119,999	227,00
28-ER-129	120,001-129,999	255,00
28-ER-139	130,001-139,999	278,00
28-ER-149	140,001-149,999	298,00
28-ER-159	150,001-159,999	343,00
28-ER-169	160,001-169,999	412,00
28-ER-179	170,001-179,999	453,00
28-ER-189	180,001-189,999	508,00
28-ER-199	190,001-199,999	549,00

01

02

03

04

05

06

07

08

09

10

11

12

13

14

15

Lehren, Einstellringe Gauges, setting rings

Gewinde-Lehren M Regelgewinde Thread gauges standard metric

für metrische ISO-Regelgewinde nach DIN 13 (rechts) |
Toleranz Dorne: 6H (bis M1,4 5H) |
Toleranz Ringe: 6g (bis M1,4 6h) |
aus gehärtetem Lehnstahl
for ISO standard metric thread according to DIN 13
(right) |
tolerance: plug gauges: 6H (up to M1.4 5H) |
tolerance ring gauges: 6g (up to M1.4 6h) |
from hardened steel



Gewinde thread	Steigung pitch	Lehrdorn plug gauge		Gut-Lehrring ring gauge (GO)		Ausschuss-Lehrring ring gauge (NOGO)	
		Art.-Nr. Order no.	EUR	Art.-Nr. Order no.	EUR	Art.-Nr. Order no.	EUR
M1	0,25	28-410	81,50	28-450	106,00	28-450A	106,00
M1,1	0,25	28-411	81,50	28-451	136,00	28-451A	136,00
M1,2	0,25	28-412	81,50	28-452	99,00	28-452A	99,00
M1,4	0,30	28-414	68,50	28-454	88,00	28-454A	88,00
M1,6	0,35	28-416	57,00	28-456	69,50	28-456A	69,50
M1,7	0,35	28-417	76,50	28-457	93,00	28-457A	93,00
M1,8	0,35	28-418	69,00	28-458	64,00	28-458A	64,00
M2	0,40	23-002	28,50	23-502	32,50	23-502A	32,50
M2,2	0,45	28-422	56,00	28-462	59,50	28-462A	59,50
M2,3	0,40	28-423	57,50	28-463	73,50	28-463A	73,50
M2,5	0,45	23-0025	28,50	23-5025	32,50	23-5025A	32,50
M2,6	0,45	28-426	68,50	28-466	66,00	28-466A	66,00
M3	0,50	23-003	28,50	23-503	28,50	23-503A	28,50
M3,5	0,60	23-0035	27,00	23-5035	28,50	23-5035A	28,50
M4	0,70	23-004	27,00	23-504	28,50	23-504A	28,50
M4,5	0,75	28-445	39,00	28-485	41,50	28-485A	41,50
M5	0,80	23-005	27,00	23-505	28,50	23-505A	28,50
M6	1,00	23-006	27,00	23-506	27,00	23-506A	27,00
M7	1,00	23-007	27,00	23-507	27,00	23-507A	27,00
M8	1,25	23-008	27,00	23-508	27,00	23-508A	27,00
M9	1,25	23-009	27,00	23-509	27,00	23-509A	27,00
M10	1,50	23-010	27,00	23-510	27,00	23-510A	27,00
M11	1,50	23-011	27,00	23-511	27,00	23-511A	27,00
M12	1,75	23-012	27,00	23-512	27,00	23-512A	27,00
M14	2,00	23-014	27,00	23-514	27,00	23-514A	27,00
M16	2,00	23-016	27,00	23-516	27,00	23-516A	27,00
M18	2,50	23-018	27,00	23-518	31,50	23-518A	31,50
M20	2,50	23-020	27,00	23-520	31,50	23-520A	31,50
M22	2,50	23-022	28,50	23-522	33,50	23-522A	33,50
M24	3,00	23-024	28,50	23-524	38,00	23-524A	38,00
M27	3,00	23-027	32,50	23-527	39,50	23-527A	39,50
M30	3,50	23-030	34,50	23-530	47,50	23-530A	47,50
M33	3,50	23-033	37,50	23-533	47,50	23-533A	47,50
M36	4,00	23-036	42,50	23-536	56,00	23-536A	56,00
M39	4,00	23-039	46,00	23-539	59,00	23-539A	59,00
M42	4,50	23-042	59,50	23-542	74,00	23-542A	74,00
M45	4,50	23-045	66,00	23-545	78,00	23-545A	78,00
M48	5,00	23-048	69,00	23-548	87,00	23-548A	87,00
M52	5,00	23-052	72,00	23-552	91,00	23-552A	91,00
M56	5,50	23-056	76,00	23-556	99,00	23-556A	99,00
M60	5,50	23-060	79,00	23-560	108,00	23-560A	108,00

Gewinde thread	Steigung pitch	Gut-Lehrdorn plug gauge (GO)		Ausschuss-Lehrdorn plug gauge (NOGO)		Gut-Lehrring ring gauge (GO)		Ausschuss-Lehrring ring gauge (NOGO)	
		Art.-Nr. Order no.	EUR	Art.-Nr. Order no.	EUR	Art.-Nr. Order no.	EUR	Art.-Nr. Order no.	EUR
M64	6,00	29-2-M64	95,00	29-3-M64	95,00	29-4-M64	188,00	29-5-M64	188,00
M68	6,00	29-2-M68	99,00	29-3-M68	99,00	29-4-M68	198,00	29-5-M68	198,00

Lehren, Einstellringe

Gauges, setting rings

Gewinde-Lehren M Regelgewinde im Satz *Thread gauges standard metric in set*

für metrische ISO-Regelgewinde nach DIN 13 (rechts) | 7teiliger Satz bestehend aus M3, M4, M5, M6, M8, M10, M12 | Toleranz Dorne: 6H / Ringe: 6g | aus gehärtetem Lehenstahl | Aufbewahrungsbox

for ISO standard metric thread according to DIN 13 (right) | Set of 7 pieces, including M3, M4, M5, M6, M8, M10, M12 | tolerance: plug gauges: 6H / ring gauges: 6g | from hardened steel | box



23-099

Lehrdorne plug gauges (GO+NOGO)	
Art.-Nr. Order no.	EUR
23-099	186,00



23-598

Gut-Lehrringe ring gauges (GO)	
Art.-Nr. Order no.	EUR
23-598	174,00

Ausschuss-Lehrringe ring gauges (NOGO)	
Art.-Nr. Order no.	EUR
23-599	174,00

Gewinde-Lehrdorne M Regelgewinde mit Schaftverlängerung *Thread plug gauges standard metric with shaft extension*

für metrische ISO-Regelgewinde nach DIN 13 (rechts) | Toleranz: 6H | Schaftverlängerung der Gut- und Ausschusseite | aus gehärtetem Lehenstahl

for ISO standard metric thread according to DIN 13 (right) | tolerance: 6H | shaft extension for GO and NOGO side | from hardened steel



50 mm

Gewinde thread	Steigung pitch	Art.-Nr. Order no.	EUR
M3	0,50	29-L-M3	89,00
M4	0,70	29-L-M4	93,00
M5	0,80	29-L-M5	96,00
M6	1,00	29-L-M6	99,00
M8	1,25	29-L-M8	102,00
M10	1,50	29-L-M10	105,00
M12	1,75	29-L-M12	111,00
M14	2,00	29-L-M14	116,00
M16	2,00	29-L-M16	124,00
M18	2,50	29-L-M18	136,00
M20	2,50	29-L-M20	142,00
M24	3,00	29-L-M24	149,00

Weitere Größen auf Anfrage!
Further sizes on request!

Lehren, Einstellringe Gauges, setting rings

Gewinde-Lehren M Regelgewinde Toleranz 6G/6e Thread gauges standard metric tolerance 6G/6e

für metrische ISO-Regelgewinde nach DIN 13 (rechts) | Toleranz: Dorne 6G, Ringe 6e (empfohlene Toleranzklasse für Gewinde mit dicken galvanischen Schutzschichten) | aus gehärtetem Lehenstahl
for ISO standard metric thread according to DIN 13 (right) | tolerance: plug gauges 6G, ring gauges 6e (recommended tolerance class for threads with thick galvanic coating) | from hardened steel



Gewinde thread	Steigung pitch	Lehrdorn plug gauge		Gut-Lehrring ring gauge (go)		Ausschuss-Lehrring ring gauge (no go)	
		Art.-Nr. Order no.	EUR	Art.-Nr. Order no.	EUR	Art.-Nr. Order no.	EUR
M2	0,40	29-802	71,50	29-902	73,50	29-902A	73,50
M2,5	0,45	29-8025	62,00	29-9025	58,50	29-9025A	58,50
M3	0,50	29-803	52,50	29-903	45,00	29-903A	45,00
M3,5	0,60	29-8035	53,50	29-9035	46,00	29-9035A	46,00
M4	0,70	29-804	49,50	29-904	41,00	29-904A	41,00
M5	0,80	29-805	48,50	29-905	41,00	29-905A	41,00
M6	1,00	29-806	46,50	29-906	41,00	29-906A	41,00
M8	1,25	29-808	48,50	29-908	42,50	29-908A	42,50
M10	1,50	29-810	51,50	29-910	48,50	29-910A	48,50
M12	1,75	29-812	55,00	29-912	54,00	29-912A	54,00
M14	2,00	29-814	59,50	29-914	58,00	29-914A	58,00
M16	2,00	29-816	63,50	29-916	64,00	29-916A	64,00
M18	2,50	29-818	75,00	29-918	74,50	29-918A	74,50
M20	2,50	29-820	79,50	29-920	82,00	29-920A	82,00
M22	2,50	29-822	85,00	29-922	99,00	29-922A	99,00
M24	3,00	29-824	96,00	29-924	106,00	29-924A	106,00
M27	3,00	29-827	107,00	29-927	118,00	29-927A	118,00
M30	3,50	29-830	118,00	29-930	129,00	29-930A	129,00

Weitere Größen auf Anfrage!
Further sizes on request!

Gewinde-Lehren M Regelgewinde Links (LH) Thread gauges standard metric left handed (LH)

für metrische ISO-Regelgewinde nach DIN 13 (links) | Toleranz: Dorne 6H, Ringe 6g | aus gehärtetem Lehenstahl
for ISO standard metric thread according to DIN 13 (left handed) | tolerance: plug gauges 6H, ring gauges 6g | from hardened steel



Gewinde thread	Steigung pitch	Lehrdorn plug gauge		Gut-Lehrring ring gauge (go)		Ausschuss-Lehrring ring gauge (no go)	
		Art.-Nr. Order no.	EUR	Art.-Nr. Order no.	EUR	Art.-Nr. Order no.	EUR
M2	0,40	28-802	83,00	28-852	81,50	28-852A	81,50
M2,5	0,45	28-8025	71,50	28-8525	64,00	28-8525A	64,00
M3	0,50	28-803	60,50	28-853	49,50	28-853A	49,50
M3,5	0,60	28-8035	62,00	28-8535	51,00	28-8535A	51,00
M4	0,70	28-804	57,00	28-854	45,50	28-854A	45,50
M5	0,80	28-805	55,50	28-855	45,50	28-855A	45,50
M6	1,00	28-806	53,50	28-856	45,50	28-856A	45,50
M8	1,25	28-808	55,50	28-858	47,00	28-858A	47,00
M10	1,50	28-810	59,50	28-860	53,50	28-860A	53,50
M12	1,75	28-812	63,50	28-862	59,50	28-862A	59,50
M14	2,00	28-814	68,50	28-864	63,50	28-864A	63,50
M16	2,00	28-816	73,50	28-866	71,00	28-866A	71,00
M18	2,50	28-818	79,50	28-868	82,50	28-868A	82,50
M20	2,50	28-820	85,50	28-870	91,00	28-870A	91,00
M22	2,50	28-822	90,00	28-872	99,50	28-872A	99,50
M24	3,00	28-824	102,00	28-874	107,00	28-874A	107,00
M27	3,00	28-827	113,00	28-877	119,00	28-877A	119,00

Weitere Größen auf Anfrage!
Further sizes on request!

Lehren, Einstellringe Gauges, setting rings

JBO Präzisions-Gewinde-Lehren M Regelgewinde Made in Germany Precision thread gauges standard metric

für metrische ISO-Regelgewinde nach DIN 13 (rechts) | Lehrenmaße nach DIN ISO 1502 | Flankenwinkel 60° | Toleranz Dorne: 6H (bis M1,4 5H) | Toleranz Ringe: 6g (bis M1,4 6h) | aus gehärtetem Lehenstahl | Made in Germany
for ISO standard metric thread according to DIN 13 (right) | gauge dimensions according to DIN ISO 1502 | flank angle 60° | tolerance plug gauges: 6H (up to M1.4 5H) | tolerance ring gauges: 6g (up to M1.4 6h) | from hardened steel | Made in Germany



35-11-M27



35-14-M20

Gewinde thread	Steigung pitch	Lehrdorn plug gauge (GO+NOGO)		Gut-Lehr링 ring gauge (GO)		Ausschuss-Lehr링 ring gauge (NOGO)	
		Art.-Nr. Order no.	EUR	Art.-Nr. Order no.	EUR	Art.-Nr. Order no.	EUR
M1	0,25	35-11-M1	122,00	35-14-M1	99,00	35-15-M1	99,00
M1,1	0,25	35-11-M1,1	142,00	35-14-M1,1	131,00	35-15-M1,1	131,00
M1,2	0,25	35-11-M1,2	103,00	35-14-M1,2	95,00	35-15-M1,2	95,00
M1,4	0,30	35-11-M1,4	83,00	35-14-M1,4	85,00	35-15-M1,4	85,00
M1,6	0,35	35-11-M1,6	77,00	35-14-M1,6	74,00	35-15-M1,6	74,00
M1,7	0,35	35-11-M1,7	87,00	35-14-M1,7	89,00	35-15-M1,7	89,00
M1,8	0,35	35-11-M1,8	71,00	35-14-M1,8	66,00	35-15-M1,8	66,00
M2	0,40	35-11-M2	63,00	35-14-M2	62,00	35-15-M2	62,00
M2,2	0,45	35-11-M2,2	67,00	35-14-M2,2	69,00	35-15-M2,2	69,00
M2,3	0,40	35-11-M2,3	70,00	35-14-M2,3	114,00	35-15-M2,3	114,00
M2,5	0,45	35-11-M2,5	55,00	35-14-M2,5	48,50	35-15-M2,5	48,50
M2,6	0,45	35-11-M2,6	68,00	35-14-M2,6	62,00	35-15-M2,6	62,00
M3	0,50	35-11-M3	46,00	35-14-M3	37,50	35-15-M3	37,50
M3,5	0,60	35-11-M3,5	47,50	35-14-M3,5	38,50	35-15-M3,5	38,50
M4	0,70	35-11-M4	43,00	35-14-M4	33,80	35-15-M4	33,80
M4,5	0,75	35-11-M4,5	59,00	35-14-M4,5	55,00	35-15-M4,5	55,00
M5	0,80	35-11-M5	42,00	35-14-M5	33,80	35-15-M5	33,80
M6	1,00	35-11-M6	39,50	35-14-M6	33,80	35-15-M6	33,80
M7	1,00	35-11-M7	44,00	35-14-M7	39,50	35-15-M7	39,50
M8	1,25	35-11-M8	42,00	35-14-M8	35,00	35-15-M8	35,00
M9	1,25	35-11-M9	55,00	35-14-M9	48,50	35-15-M9	48,50
M10	1,50	35-11-M10	44,50	35-14-M10	39,50	35-15-M10	39,50
M11	1,50	35-11-M11	59,00	35-14-M11	57,00	35-15-M11	57,00
M12	1,75	35-11-M12	48,00	35-14-M12	44,50	35-15-M12	44,50
M14	2,00	35-11-M14	52,00	35-14-M14	48,00	35-15-M14	48,00
M16	2,00	35-11-M16	56,00	35-14-M16	53,50	35-15-M16	53,50
M18	2,50	35-11-M18	60,00	35-14-M18	62,00	35-15-M18	62,00
M20	2,50	35-11-M20	65,00	35-14-M20	68,50	35-15-M20	68,50
M22	2,50	35-11-M22	68,00	35-14-M22	76,00	35-15-M22	76,00
M24	3,00	35-11-M24	77,00	35-14-M24	81,00	35-15-M24	81,00
M27	3,00	35-11-M27	86,00	35-14-M27	91,00	35-15-M27	91,00
M30	3,50	35-11-M30	95,00	35-14-M30	99,00	35-15-M30	99,00
M33	3,50	35-11-M33	106,00	35-14-M33	109,00	35-15-M33	109,00
M36	4,00	35-11-M36	114,00	35-14-M36	117,00	35-15-M36	117,00
M39	4,00	35-11-M39	125,00	35-14-M39	127,00	35-15-M39	127,00

Fortsetzung: siehe nächste Seite!
Continuation: see following page!

Weitere JBO-Gewindelehren auf Anfrage!
Further JBO-thread gauges on request!



JBO Präzisions-Gewinde-Lehren M Regelgewinde Made in Germany (Fortsetzung) Precision thread gauges standard metric (continuation)

für metrische ISO-Regelgewinde nach DIN 13 (rechts) | Lehrenmaße nach DIN ISO 1502 | Flankenwinkel 60° | Toleranz Dorne: 6H | Toleranz Ringe: 6g | ab M42 Gut- und Ausschuss-Lehrdorn nur separat lieferbar | aus gehärtetem Lehrenstahl | Made in Germany
for ISO standard metric thread according to DIN 13 (right) | gauge dimensions according to DIN ISO 1502 | flank angle 60° | tolerance plug gauges: 6H | tolerance ring gauges: 6g | from M42 GO and NOGO plug gauge available only separately | from hardened steel | Made in Germany



Gewinde thread	Steigung pitch	Gut-Lehrdorn plug gauge (GO)		Ausschuss-Lehrdorn plug gauge (NOGO)		Gut-Lehrring ring gauge (GO)		Ausschuss-Lehrring ring gauge (NOGO)	
		Art.-Nr. Order no.	EUR	Art.-Nr. Order no.	EUR	Art.-Nr. Order no.	EUR	Art.-Nr. Order no.	EUR
M42	4,50	35-12-M42	83,00	35-13-M42	74,50	35-14-M42	138,00	35-15-M42	138,00
M45	4,50	35-12-M45	89,00	35-13-M45	81,00	35-14-M45	146,00	35-15-M45	146,00
M48	5,00	35-12-M48	96,00	35-13-M48	87,00	35-14-M48	155,00	35-15-M48	155,00
M52	5,00	35-12-M52	103,00	35-13-M52	93,00	35-14-M52	167,00	35-15-M52	167,00
M56	5,50	35-12-M56	114,00	35-13-M56	103,00	35-14-M56	178,00	35-15-M56	178,00
M60	5,50	35-12-M60	128,00	35-13-M60	117,00	35-14-M60	238,00	35-15-M60	238,00
M64	6,00	35-12-M64	141,00	35-13-M64	128,00	35-14-M64	253,00	35-15-M64	253,00
M68	6,00	35-12-M68	149,00	35-13-M68	136,00	35-14-M68	269,00	35-15-M68	269,00

Weitere JBO-Gewindelehren auf Anfrage!
Further JBO-thread gauges on request!

JBO Gewinde-Koordinatenmessdorne Thread coordinate gauge rod

Zur Bestimmung der Position und Winkligkeit eines Innengewindes mittels 3D-Messmaschine | für metrische ISO-Gewinde nach DIN 13 (rechts) | Ausführung: Steigungsverzug im Gewinde (stützt sich an zwei Gewindeflanken ab) | aus gehärtetem Lehrenstahl
For determination of position and angularity of inside threads via 3D measuring machine | for ISO metric thread according to DIN 13 (right) | Specification: Pitch correction of the thread (fitted in two thread flanks for centric mounting) | from hardened steel



Anwendungsbeispiel:
Example of use:



Weitere Größen auf Anfrage!
Further sizes on request!

Regelgewinde Standard metric thread		
Gewinde thread	Art.-Nr. Order no.	EUR
M3	29-KO-M3	220,00
M4	29-KO-M4	210,00
M5	29-KO-M5	205,00
M6	29-KO-M6	205,00
M8	29-KO-M8	205,00
M10	29-KO-M10	220,00
M12	29-KO-M12	230,00
M14	29-KO-M14	250,00
M16	29-KO-M16	270,00

Feingewinde Metric fine thread		
Gewinde thread	Art.-Nr. Order no.	EUR
M8x1	29-KO-M8x1	220,00
M10x1	29-KO-M10x1	235,00
M12x1	29-KO-M12x1	255,00
M12x1,5	29-KO-M12x1,5	235,00
M14x1,5	29-KO-M14x1,5	250,00
M16x1	29-KO-M16x1	290,00
M16x1,5	29-KO-M16x1,5	260,00

Lehren, Einstellringe Gauges, setting rings

JBO Gewinde-Lehren „MultiCheck“ mit Gewindetiefe-Prüfung Thread gauges „MultiCheck“ with checking of thread depth

für metrische ISO-Regelgewinde nach DIN 13 (rechts) | Toleranz 6H | Ablesung 0,5 mm (Skala) / 0,1 mm (Nonius) / 0,01 mm (Digital) | Messtiefe bis 4x Ø

for ISO standard metric thread according to DIN 13 (right) | tolerance 6H | Reading 0.5 mm (scale) / 0.1 mm (vernier) / 0.01 mm (digital) | thread depth up to 4x Ø



Gewinde thread	Steigung pitch	mit Skala with scale		mit Nonius with vernier		mit Digital-Anzeige with digital readout	
		Art.-Nr. Order no.	EUR	Art.-Nr. Order no.	EUR	Art.-Nr. Order no.	EUR
M2	0,40	48-502	277,00	48-602	403,00	48-702	662,00
M2,5	0,45	48-5025	269,00	48-6025	382,00	48-7025	654,00
M3	0,50	48-503	262,00	48-603	375,00	48-703	645,00
M3,5	0,60	48-5035	269,00	48-6035	382,00	48-7035	654,00
M4	0,70	48-504	256,00	48-604	369,00	48-704	649,00
M5	0,80	48-505	251,00	48-605	358,00	48-705	640,00
M6	1,00	48-506	234,00	48-606	347,00	48-706	631,00
M8	1,25	48-508	277,00	48-608	387,00	48-708	668,00
M10	1,50	48-510	281,00	48-610	391,00	48-710	671,00
M12	1,75	48-512	299,00	48-612	419,00	48-712	799,00
M14	2,00	48-514	303,00	48-614	422,00	48-714	812,00
M16	2,00	48-516	366,00	48-616	498,00	48-716	839,00
M18	2,50	48-518	370,00	48-618	502,00	48-718	850,00
M20	2,50	48-520	514,00	48-620	658,00	48-720	862,00

Weitere Größen und Modelle (auch motorisiert) auf Anfrage!
Further sizes and models (also motorized) on request!

Einstellehre setting gauge:
zur Überprüfung und Einstellung der Nullstellung der Tiefenmeseinrichtung
for checking and adjusting of zero-position of depth measuring



Art.-Nr. Order no.	EUR
48-500	249,00



Lehren, Einstellringe Gauges, setting rings

Gewinde-Lehren M Feingewinde Thread gauges metric fine

für metrische ISO-Feingewinde nach DIN 13 (rechts) | Toleranz: Dorne 6H, Ringe 6g | aus gehärtetem Lehenstahl
for ISO fine metric thread according to DIN 13 (right) | tolerance: plug gauges 6H, ring gauges 6g | from hardened steel



Gewinde thread	Lehrdorn plug gauge (GO+NOGO)		Gut-Lehrring ring gauge (GO)		Ausschuss- Lehrring ring gauge (NOGO)		Gewinde thread	Lehrdorn plug gauge (GO+NOGO)		Gut-Lehrring ring gauge (GO)		Ausschuss- Lehrring ring gauge (NOGO)	
	Art.-Nr. Order no.	EUR	Art.-Nr. Order no.	EUR	Art.-Nr. Order no.	EUR		Art.-Nr. Order no.	EUR	Art.-Nr. Order no.	EUR	Art.-Nr. Order no.	EUR
Toleranz bis M1.4: Dorne 5H / Ringe 6h <i>tolerance up to M1.4: plug gauges 5H / ring gauges 6h</i>													
M1x0,2	29-1X01	153,00	29-4X01	276,00	29-5X01	276,00	M9x0,75	29-1209	54,00	29-4209	48,00	29-5209	48,00
M1,2x0,2	29-1X012	148,00	29-4X012	269,00	29-5X012	269,00	M9x1	25-309	26,50	26-309	29,00	27-309	29,00
M1,4x0,2	29-1X014	143,00	29-4X014	256,00	29-5X014	256,00	M10x0,35	29-1010	97,00	29-4010	104,00	29-5010	104,00
Toleranz ab M1.6: Dorne 6H / Ringe 6g <i>tolerance from M1.6: plug gauges 6H / ring gauges 6g</i>													
M1,6x0,2	29-1X016	133,00	29-4X016	235,00	29-5X016	235,00	M10x0,5	25-110	27,50	26-110	32,50	27-110	32,50
M1,8x0,2	29-1X018	122,00	29-4X018	229,00	29-5X018	229,00	M10x0,75	25-210	27,50	26-210	32,50	27-210	32,50
M2x0,2	29-1X02	122,00	29-4X02	229,00	29-5X02	229,00	M10x1	25-310	26,50	26-310	29,00	27-310	29,00
M2x0,25	29-1Y02	128,00	29-4Y02	174,00	29-5Y02	174,00	M10x1,25	25-410	26,50	26-410	29,00	27-410	29,00
M2x0,35	25-002	32,50	26-002	32,50	27-002	32,50	M11x0,5	29-1111	71,50	29-4111	81,00	29-5111	81,00
M2,2x0,2	29-1X022	122,00	29-4X022	219,00	29-5X022	219,00	M11x0,75	29-1211	57,50	29-4211	62,50	29-5211	62,50
M2,5x0,2	29-1X025	122,00	29-4X025	205,00	29-5X025	205,00	M11x1	29-1311	44,50	29-4311	43,00	29-5311	43,00
M2,5x0,35	25-0025	32,50	26-0025	32,50	27-0025	32,50	M12x0,5	25-112	27,50	26-112	32,50	27-112	32,50
M3x0,2	29-1X03	118,00	29-4X03	199,00	29-5X03	199,00	M12x0,75	25-212	27,50	26-212	32,50	27-212	32,50
M3x0,25	29-1Y03	113,00	29-4Y03	158,00	29-5Y03	158,00	M12x1	25-312	26,50	26-312	29,00	27-312	29,00
M3x0,35	25-003	32,50	26-003	32,50	27-003	32,50	M12x1,25	25-412	26,50	26-412	29,00	27-412	29,00
M3,5x0,35	25-0035	32,50	26-0035	32,50	27-0035	32,50	M12x1,5	25-512	26,50	26-512	29,00	27-512	29,00
M4x0,25	29-1Y04	118,00	29-4Y04	148,00	29-5Y04	148,00	M13x0,5	29-1113	109,00	29-4113	93,00	29-5113	93,00
M4x0,35	25-004	32,50	26-004	32,50	27-004	32,50	M13x0,75	25-213	27,50	26-213	32,50	27-213	32,50
M4x0,5	25-104	27,50	26-104	32,50	27-104	32,50	M13x1	25-313	26,50	26-313	29,00	27-313	29,00
M4,5x0,5	29-11045	59,50	29-41045	72,50	29-51045	72,50	M13x1,5	25-513	26,50	26-513	29,00	27-513	29,00
M5x0,25	29-1Y05	123,00	29-4Y05	148,00	29-5Y05	148,00	M14x0,5	25-114	27,50	26-114	32,50	27-114	32,50
M5x0,35	25-005	27,50	26-005	32,50	27-005	32,50	M14x0,75	25-214	27,50	26-214	32,50	27-214	32,50
M5x0,5	25-105	27,50	26-105	32,50	27-105	32,50	M14x1	25-314	26,50	26-314	29,00	27-314	29,00
M5x0,75	25-205	27,50	26-205	32,50	27-205	32,50	M14x1,25	25-414	26,50	26-414	29,00	27-414	29,00
M6x0,25	29-1Y06	123,00	29-4Y06	153,00	29-5Y06	153,00	M14x1,5	25-514	26,50	26-514	29,00	27-514	29,00
M6x0,35	25-006	27,50	26-006	32,50	27-006	32,50	M15x0,5	29-1115	79,50	29-4115	99,00	29-5115	99,00
M6x0,5	25-106	27,50	26-106	32,50	27-106	32,50	M15x0,75	25-215	27,50	26-215	32,50	27-215	32,50
M6x0,75	25-206	27,50	26-206	32,50	27-206	32,50	M15x1	25-315	26,50	26-315	29,00	27-315	29,00
M7x0,5	29-1107	61,00	29-4107	58,00	29-5107	58,00	M15x1,5	25-515	26,50	26-515	29,00	27-515	29,00
M7x0,75	25-207	27,50	26-207	32,50	27-207	32,50	M16x0,5	29-1116	99,00	29-4116	97,00	29-5116	97,00
M8x0,35	29-1008	89,50	29-4008	87,00	29-5008	87,00	M16x0,75	25-216	27,50	26-216	32,50	27-216	32,50
M8x0,5	25-108	27,50	26-108	32,50	27-108	32,50	M16x1	25-316	26,50	26-316	29,00	27-316	29,00
M8x0,75	25-208	27,50	26-208	32,50	27-208	32,50	M16x1,5	25-516	26,50	26-516	29,00	27-516	29,00
M8x1	25-308	26,50	26-308	29,00	27-308	29,00	M17x0,5	29-1117	99,00	29-4117	111,00	29-5117	111,00
M9x0,5	29-1109	68,50	29-4109	64,50	29-5109	64,50	M17x1	25-317	26,50	26-317	31,00	27-317	31,00

Gewinde-Lehren M Feingewinde (Fortsetzung) Thread gauges metric fine (continuation)

für metrische ISO-Feingewinde nach DIN 13 (rechts) | Toleranz: Dorne 6H, Ringe 6g | aus gehärtetem Lehenstahl
for ISO fine metric thread according to DIN 13 (right) | tolerance: plug gauges 6H, ring gauges 6g | from hardened steel

Gewinde thread	Lehrdorn plug gauge (GO+NOGO)		Gut-Lehrring ring gauge (GO)		Ausschuss- Lehrring ring gauge (NOGO)		Gewinde thread	Lehrdorn plug gauge (GO+NOGO)		Gut-Lehrring ring gauge (GO)		Ausschuss- Lehrring ring gauge (NOGO)	
	Art.-Nr. Order no.	EUR	Art.-Nr. Order no.	EUR	Art.-Nr. Order no.	EUR		Art.-Nr. Order no.	EUR	Art.-Nr. Order no.	EUR	Art.-Nr. Order no.	EUR
M18x1,5	25-518	26,50	26-518	31,00	27-518	31,00	M30x1	25-330	29,00	26-330	41,50	27-330	41,50
M18x2	25-618	26,50	26-618	31,00	27-618	31,00	M30x1,5	25-530	29,00	26-530	41,50	27-530	41,50
M19x0,5	29-1119	129,00	29-4119	122,00	29-5119	122,00	M30x2	25-630	29,00	26-630	41,50	27-630	41,50
M19x0,75	29-1219	86,00	29-4219	88,00	29-5219	88,00	M30x3	25-730	29,00	26-730	41,50	27-730	41,50
M19x1	29-1319	58,00	29-4319	69,50	29-5319	69,50	M31x1	29-1331	136,00	29-4331	132,00	29-5331	132,00
M19x1,5	29-1519	137,00	29-4519	117,00	29-5519	117,00	M32x0,75	29-1232	277,00	29-4232	239,00	29-5232	239,00
M20x0,5	29-1120	107,00	29-4120	122,00	29-5120	122,00	M32x1	29-1332	87,50	29-4332	101,00	29-5332	101,00
M20x0,75	25-220	27,50	26-220	32,50	27-220	32,50	M32x1,5	25-532	29,00	26-532	41,50	27-532	41,50
M20x1	25-320	26,50	26-320	31,00	27-320	31,00	M32x2	25-632	29,00	26-632	41,50	27-632	41,50
M20x1,5	25-520	26,50	26-520	31,00	27-520	31,00	M33x1	25-333	29,00	26-333	41,50	27-333	41,50
M20x2	25-620	26,50	26-620	31,00	27-620	31,00	M33x1,5	25-533	29,00	26-533	41,50	27-533	41,50
M21x1	29-1321	63,00	29-4321	75,00	29-5321	75,00	M33x2	25-633	29,00	26-633	41,50	27-633	41,50
M21x1,5	29-1521	148,00	29-4521	163,00	29-5521	163,00	M33x3	25-733	29,00	26-733	41,50	27-733	41,50
M22x0,5	29-1122	232,00	29-4122	226,00	29-5122	226,00	M34x1	25-334	29,00	26-334	41,50	27-334	41,50
M22x0,75	29-1222	84,00	29-4222	92,50	29-5222	92,50	M34x1,5	25-534	29,00	26-534	41,50	27-534	41,50
M22x1	25-322	26,50	26-322	31,00	27-322	31,00	M34x2	25-634	29,00	26-634	41,50	27-634	41,50
M22x1,5	25-522	26,50	26-522	31,00	27-522	31,00	M34x3	25-734	29,00	26-734	41,50	27-734	41,50
M22x2	25-622	26,50	26-622	31,00	27-622	31,00	M35x1	25-335	29,00	26-335	48,50	27-335	48,50
M23x1	29-1323	68,00	29-4323	87,00	29-5323	87,00	M35x1,5	25-535	29,00	26-535	48,50	27-535	48,50
M24x0,5	29-1124	234,00	29-4124	226,00	29-5124	226,00	M35x2	25-635	29,00	26-635	48,50	27-635	48,50
M24x0,75	29-1224	89,00	29-4224	98,00	29-5224	98,00	M35x3	25-735	29,00	26-735	48,50	27-735	48,50
M24x1	25-324	26,50	26-324	31,00	27-324	31,00	M36x1	25-336	36,00	26-336	52,00	27-336	52,00
M24x1,5	25-524	26,50	26-524	31,00	27-524	31,00	M36x1,5	25-536	36,00	26-536	52,00	27-536	52,00
M24x2	25-624	26,50	26-624	31,00	27-624	31,00	M36x2	25-636	36,00	26-636	52,00	27-636	52,00
M25x0,75	29-1225	94,00	29-4225	104,00	29-5225	104,00	M36x3	25-736	36,00	26-736	52,00	27-736	52,00
M25x1	25-325	26,50	26-325	31,00	27-325	31,00	M38x1	25-338	36,00	26-338	52,00	27-338	52,00
M25x1,5	25-525	26,50	26-525	31,00	27-525	31,00	M38x1,5	25-538	36,00	26-538	52,00	27-538	52,00
M25x2	25-625	26,50	26-625	31,00	27-625	31,00	M38x2	25-638	36,00	26-638	52,00	27-638	52,00
M26x0,75	29-1226	97,00	29-4226	113,00	29-5226	113,00	M38x3	25-738	36,00	26-738	52,00	27-738	52,00
M26x1	25-326	26,50	26-326	31,00	27-326	31,00	M39x1	25-339	38,50	26-339	54,00	27-339	54,00
M26x1,5	25-526	26,50	26-526	31,00	27-526	31,00	M39x1,5	25-539	38,50	26-539	54,00	27-539	54,00
M26x2	25-626	26,50	26-626	31,00	27-626	31,00	M39x2	25-639	38,50	26-639	54,00	27-639	54,00
M27x0,75	29-1227	99,00	29-4227	117,00	29-5227	117,00	M39x3	25-739	38,50	26-739	54,00	27-739	54,00
M27x1	25-327	26,50	26-327	34,50	27-327	34,50	M40x1	25-340	38,50	26-340	54,00	27-340	54,00
M27x1,5	25-527	26,50	26-527	34,50	27-527	34,50	M40x1,5	25-540	38,50	26-540	54,00	27-540	54,00
M27x2	25-627	26,50	26-627	34,50	27-627	34,50	M40x2	25-640	38,50	26-640	54,00	27-640	54,00
M28x0,75	29-1228	99,00	29-4228	122,00	29-5228	122,00	M40x3	25-740	38,50	26-740	54,00	27-740	54,00
M28x1	25-328	26,50	26-328	34,50	27-328	34,50	M42x1	25-342	53,00	26-342	65,00	27-342	65,00
M28x1,5	25-528	26,50	26-528	34,50	27-528	34,50	M42x1,5	25-542	53,00	26-542	65,00	27-542	65,00
M28x2	25-628	26,50	26-628	34,50	27-628	34,50	M42x2	25-642	53,00	26-642	65,00	27-642	65,00
M29x1	29-1329	115,00	29-4329	156,00	29-5329	156,00	M42x3	25-742	53,00	26-742	65,00	27-742	65,00
M30x0,75	29-1230	110,00	29-4230	126,00	29-5230	126,00							



Gewinde-Lehren M Feingewinde (Fortsetzung) Thread gauges metric fine (continuation)

für metrische ISO-Feingewinde nach DIN 13 (rechts) | Toleranz: Dorne 6H, Ringe 6g | aus gehärtetem Lehenstahl
 for ISO fine metric thread according to DIN 13 (right) | tolerance: plug gauges 6H, ring gauges 6g | from hardened steel

Gewinde thread	Lehrdorn plug gauge (GO+NOGO)		Gut-Lehrdorn plug gauge (GO)		Ausschuss-Lehrdorn plug gauge (NOGO)		Gut-Lehrring ring gauge (GO)		Ausschuss-Lehrring ring gauge (NOGO)	
	Art.-Nr. Order no.	EUR	Art.-Nr. Order no.	EUR	Art.-Nr. Order no.	EUR	Art.-Nr. Order no.	EUR	Art.-Nr. Order no.	EUR
M44x1	25-344	61,50					26-344	65,00	27-344	65,00
M44x1,5	25-544	61,50					26-544	65,00	27-544	65,00
M45x1	25-345	61,50					26-345	73,50	27-345	73,50
M45x1,5	25-545	61,50	29-2545	59,00	29-3545	55,00	26-545	73,50	27-545	73,50
M45x2	25-645	61,50	29-2645	57,00	29-3645	53,00	26-645	73,50	27-645	73,50
M45x3	25-745	61,50					26-745	73,50	27-745	73,50
M46x1	25-346	61,50					26-346	73,50	27-346	73,50
M46x1,5	25-546	61,50					26-546	73,50	27-546	73,50
M48x1	25-348	61,50					26-348	82,00	27-348	82,00
M48x1,5	25-548	61,50					26-548	82,00	27-548	82,00
M48x2	25-648	61,50	29-2648	59,50	29-3648	56,00	26-648	82,00	27-648	82,00
M48x3	25-748	61,50					26-748	82,00	27-748	82,00
M50x1	25-350	61,50					26-350	82,00	27-350	82,00
M50x1,5	25-550	61,50					26-550	82,00	27-550	82,00
M50x2	25-650	61,50					26-650	82,00	27-650	82,00
M50x3			29-2750	72,50	29-3750	67,50	29-4750	135,00	29-5750	135,00
M52x1	25-352	61,50					26-352	82,00	27-352	82,00
M52x1,5	25-552	61,50					26-552	82,00	27-552	82,00
M52x2	25-652	61,50					26-652	82,00	27-652	82,00
M52x3	25-752	61,50					26-752	82,00	27-752	82,00
M55x1	25-355	67,00					26-355	97,00	27-355	97,00
M55x1,5			29-2555	69,50	29-3555	64,50	29-4555	141,00	29-5555	141,00
M55x2	25-655	67,00					26-655	97,00	27-655	97,00
M56x1	25-356	67,00					26-356	97,00	27-356	97,00
M56x1,5			29-2556	71,00	29-3556	66,50	29-4556	143,00	29-5556	143,00
M56x2	25-656	67,00					26-656	97,00	27-656	97,00
M56x3			29-2756	81,00	29-3756	76,00	29-4756	175,00	29-5756	175,00
M56x4			29-2856	99,00	29-3856	93,00	29-4856	179,00	29-5856	179,00
M58x1			29-2358	91,00	29-3358	84,00	29-4358	198,00	29-5358	198,00
M58x1,5			29-2558	73,50	29-3558	68,50	29-4558	149,00	29-5558	149,00
M58x2	25-658	78,50	29-2658	74,50	29-3658	69,50	26-658	109,00	27-658	109,00
M58x3			29-2758	84,00	29-3758	79,00	29-4758	179,00	29-5758	179,00
M60x1	25-360	78,50					26-360	109,00	27-360	109,00
M60x1,5			29-2560	76,00	29-3560	71,00	29-4560	152,00	29-5560	152,00
M60x2	25-660	78,50					26-660	109,00	27-660	109,00
M60x3			29-2760	87,00	29-3760	82,00	29-4760	181,00	29-5760	181,00
M60x4			29-2860	103,00	29-3860	97,00	29-4860	187,00	29-5860	187,00
M62x1			29-2362	109,00	29-3362	99,00	29-4362	204,00	29-5362	204,00
M62x1,5			29-2562	77,00	29-3562	72,00	29-4562	157,00	29-5562	157,00
M62x2	25-662	97,00	29-2662	78,50	29-3662	73,50	26-662	109,00	27-662	109,00
M62x3			29-2762	89,50	29-3762	84,50	29-4762	184,00	29-5762	184,00
M62x4			29-2862	105,00	29-3862	99,00	29-4862	189,00	29-5862	189,00

Gewinde-Lehren M Feingewinde (Fortsetzung) Thread gauges metric fine (continuation)

für metrische ISO-Feingewinde nach DIN 13 (rechts) | Toleranz: Dorne 6H, Ringe 6g | aus gehärtetem Lehenstahl
 for ISO fine metric thread according to DIN 13 (right) | tolerance: plug gauges 6H, ring gauges 6g | from hardened steel

Gewinde thread	Gut-Lehrdorn plug gauge (GO)		Ausschuss-Lehrdorn plug gauge (NOGO)		Gut-Lehrring ring gauge (GO)		Ausschuss-Lehrring ring gauge (NOGO)	
	Art.-Nr. Order no.	EUR	Art.-Nr. Order no.	EUR	Art.-Nr. Order no.	EUR	Art.-Nr. Order no.	EUR
M64x1	29-2-M64x1	111,00	29-3-M64x1	99,00	29-4-M64x1	206,00	29-5-M64x1	206,00
M64x1,5	29-2-M64x1,5	78,00	29-3-M64x1,5	73,00	29-4-M64x1,5	163,00	29-5-M64x1,5	163,00
M64x2	29-2-M64x2	81,00	29-3-M64x2	75,00	29-4-M64x2	158,00	29-5-M64x2	158,00
M64x3	29-2-M64x3	92,00	29-3-M64x3	87,00	29-4-M64x3	186,00	29-5-M64x3	186,00
M64x4	29-2-M64x4	107,00	29-3-M64x4	99,00	29-4-M64x4	193,00	29-5-M64x4	193,00
M65x1	29-2-M65x1	113,00	29-3-M65x1	103,00	29-4-M65x1	209,00	29-5-M65x1	209,00
M65x1,5	29-2-M65x1,5	81,00	29-3-M65x1,5	75,00	29-4-M65x1,5	165,00	29-5-M65x1,5	165,00
M65x2	29-2-M65x2	83,00	29-3-M65x2	77,00	29-4-M65x2	163,00	29-5-M65x2	163,00
M65x3	29-2-M65x3	94,00	29-3-M65x3	89,00	29-4-M65x3	189,00	29-5-M65x3	189,00
M65x4	29-2-M65x4	109,00	29-3-M65x4	103,00	29-4-M65x4	196,00	29-5-M65x4	196,00
M68x1	29-2-M68x1	116,00	29-3-M68x1	106,00	29-4-M68x1	213,00	29-5-M68x1	213,00
M68x1,5	29-2-M68x1,5	83,00	29-3-M68x1,5	77,00	29-4-M68x1,5	169,00	29-5-M68x1,5	169,00
M68x2	29-2-M68x2	85,00	29-3-M68x2	79,00	29-4-M68x2	168,00	29-5-M68x2	168,00
M68x3	29-2-M68x3	96,00	29-3-M68x3	90,00	29-4-M68x3	192,00	29-5-M68x3	192,00
M68x4	29-2-M68x4	112,00	29-3-M68x4	105,00	29-4-M68x4	199,00	29-5-M68x4	199,00
M70x1	29-2-M70x1	119,00	29-3-M70x1	109,00	29-4-M70x1	215,00	29-5-M70x1	215,00
M70x1,5	29-2-M70x1,5	87,00	29-3-M70x1,5	82,00	29-4-M70x1,5	173,00	29-5-M70x1,5	173,00
M70x2	29-2-M70x2	87,00	29-3-M70x2	82,00	29-4-M70x2	175,00	29-5-M70x2	175,00
M70x3	29-2-M70x3	98,00	29-3-M70x3	92,00	29-4-M70x3	194,00	29-5-M70x3	194,00
M70x4	29-2-M70x4	114,00	29-3-M70x4	107,00	29-4-M70x4	205,00	29-5-M70x4	205,00
M70x6	29-2-M70x6	119,00	29-3-M70x6	113,00	29-4-M70x6	243,00	29-5-M70x6	243,00
M72x1	29-2-M72x1	121,00	29-3-M72x1	111,00	29-4-M72x1	220,00	29-5-M72x1	220,00
M72x1,5	29-2-M72x1,5	89,00	29-3-M72x1,5	84,00	29-4-M72x1,5	175,00	29-5-M72x1,5	175,00
M72x2	29-2-M72x2	90,00	29-3-M72x2	85,00	29-4-M72x2	179,00	29-5-M72x2	179,00
M72x3	29-2-M72x3	99,00	29-3-M72x3	94,00	29-4-M72x3	197,00	29-5-M72x3	197,00
M72x4	29-2-M72x4	115,00	29-3-M72x4	108,00	29-4-M72x4	208,00	29-5-M72x4	208,00
M72x6	29-2-M72x6	123,00	29-3-M72x6	116,00	29-4-M72x6	248,00	29-5-M72x6	248,00
M74x1,5	29-2-M74x1,5	153,00	29-3-M74x1,5	153,00	29-4-M74x1,5	199,00	29-5-M74x1,5	199,00
M74x2	29-2-M74x2	98,00	29-3-M74x2	98,00	29-4-M74x2	226,00	29-5-M74x2	226,00
M75x1	29-2-M75x1	124,00	29-3-M75x1	114,00	29-4-M75x1	232,00	29-5-M75x1	232,00
M75x1,5	29-2-M75x1,5	91,00	29-3-M75x1,5	86,00	29-4-M75x1,5	181,00	29-5-M75x1,5	181,00
M75x2	29-2-M75x2	92,00	29-3-M75x2	87,00	29-4-M75x2	182,00	29-5-M75x2	182,00
M75x3	29-2-M75x3	102,00	29-3-M75x3	96,00	29-4-M75x3	203,00	29-5-M75x3	203,00
M75x4	29-2-M75x4	117,00	29-3-M75x4	110,00	29-4-M75x4	213,00	29-5-M75x4	213,00
M76x1	29-2-M76x1	133,00	29-3-M76x1	121,00	29-4-M76x1	244,00	29-5-M76x1	244,00
M76x1,5	29-2-M76x1,5	92,00	29-3-M76x1,5	87,00	29-4-M76x1,5	189,00	29-5-M76x1,5	189,00
M76x2	29-2-M76x2	97,00	29-3-M76x2	92,00	29-4-M76x2	191,00	29-5-M76x2	191,00
M76x3	29-2-M76x3	105,00	29-3-M76x3	99,00	29-4-M76x3	212,00	29-5-M76x3	212,00
M76x4	29-2-M76x4	121,00	29-3-M76x4	114,00	29-4-M76x4	224,00	29-5-M76x4	224,00
M76x6	29-2-M76x6	131,00	29-3-M76x6	124,00	29-4-M76x6	268,00	29-5-M76x6	268,00
M78x1	29-2-M78x1	136,00	29-3-M78x1	124,00	29-4-M78x1	249,00	29-5-M78x1	249,00
M78x1,5	29-2-M78x1,5	94,00	29-3-M78x1,5	88,00	29-4-M78x1,5	194,00	29-5-M78x1,5	194,00
M78x2	29-2-M78x2	99,00	29-3-M78x2	94,00	29-4-M78x2	198,00	29-5-M78x2	198,00
M80x1	29-2-M80x1	139,00	29-3-M80x1	128,00	29-4-M80x1	258,00	29-5-M80x1	258,00



Gewinde-Lehren M Feingewinde (Fortsetzung) Thread gauges metric fine (continuation)

für metrische ISO-Feingewinde nach DIN 13 (rechts) | Toleranz: Dorne 6H, Ringe 6g | aus gehärtetem Lehenstahl
 for ISO fine metric thread according to DIN 13 (right) | tolerance: plug gauges 6H, ring gauges 6g | from hardened steel

Gewinde thread	Gut-Lehrdorn plug gauge (GO)		Ausschuss-Lehrdorn plug gauge (NOGO)		Gut-Lehrring ring gauge (GO)		Ausschuss-Lehrring ring gauge (NOGO)	
	Art.-Nr. Order no.	EUR	Art.-Nr. Order no.	EUR	Art.-Nr. Order no.	EUR	Art.-Nr. Order no.	EUR
M80x1,5	29-2-M80x1,5	97,00	29-3-M80x1,5	89,00	29-4-M80x1,5	205,00	29-5-M80x1,5	205,00
M80x2	29-2-M80x2	99,00	29-3-M80x2	95,00	29-4-M80x2	207,00	29-5-M80x2	207,00
M80x3	29-2-M80x3	110,00	29-3-M80x3	103,00	29-4-M80x3	217,00	29-5-M80x3	217,00
M80x4	29-2-M80x4	124,00	29-3-M80x4	116,00	29-4-M80x4	235,00	29-5-M80x4	235,00
M80x6	29-2-M80x6	137,00	29-3-M80x6	129,00	29-4-M80x6	281,00	29-5-M80x6	281,00
M82x1,5	29-2-M82x1,5	99,00	29-3-M82x1,5	93,00	29-4-M82x1,5	213,00	29-5-M82x1,5	213,00
M82x2	29-2-M82x2	149,00	29-3-M82x2	137,00	29-4-M82x2	266,00	29-5-M82x2	266,00
M85x1	29-2-M85x1	149,00	29-3-M85x1	149,00	29-4-M85x1	307,00	29-5-M85x1	307,00
M85x1,5	29-2-M85x1,5	102,00	29-3-M85x1,5	96,00	29-4-M85x1,5	219,00	29-5-M85x1,5	219,00
M85x2	29-2-M85x2	102,00	29-3-M85x2	96,00	29-4-M85x2	211,00	29-5-M85x2	211,00
M85x3	29-2-M85x3	114,00	29-3-M85x3	107,00	29-4-M85x3	236,00	29-5-M85x3	236,00
M85x4	29-2-M85x4	126,00	29-3-M85x4	118,00	29-4-M85x4	246,00	29-5-M85x4	246,00
M85x6	29-2-M85x6	145,00	29-3-M85x6	138,00	29-4-M85x6	298,00	29-5-M85x6	298,00
M88x1	29-2-M88x1	158,00	29-3-M88x1	158,00	29-4-M88x1	312,00	29-5-M88x1	312,00
M88x1,5	29-2-M88x1,5	104,00	29-3-M88x1,5	97,00	29-4-M88x1,5	229,00	29-5-M88x1,5	229,00
M88x2	29-2-M88x2	107,00	29-3-M88x2	101,00	29-4-M88x2	227,00	29-5-M88x2	227,00
M90x1	29-2-M90x1	171,00	29-3-M90x1	171,00	29-4-M90x1	373,00	29-5-M90x1	373,00
M90x1,5	29-2-M90x1,5	109,00	29-3-M90x1,5	102,00	29-4-M90x1,5	237,00	29-5-M90x1,5	237,00
M90x2	29-2-M90x2	110,00	29-3-M90x2	104,00	29-4-M90x2	237,00	29-5-M90x2	237,00
M90x3	29-2-M90x3	126,00	29-3-M90x3	118,00	29-4-M90x3	268,00	29-5-M90x3	268,00
M90x4	29-2-M90x4	135,00	29-3-M90x4	128,00	29-4-M90x4	281,00	29-5-M90x4	281,00
M90x6	29-2-M90x6	158,00	29-3-M90x6	150,00	29-4-M90x6	328,00	29-5-M90x6	328,00
M92x1,5	29-2-M92x1,5	112,00	29-3-M92x1,5	104,00	29-4-M92x1,5	242,00	29-5-M92x1,5	242,00
M92x2	29-2-M92x2	113,00	29-3-M92x2	107,00	29-4-M92x2	244,00	29-5-M92x2	244,00
M95x1,5	29-2-M95x1,5	116,00	29-3-M95x1,5	108,00	29-4-M95x1,5	247,00	29-5-M95x1,5	247,00
M95x2	29-2-M95x2	116,00	29-3-M95x2	110,00	29-4-M95x2	251,00	29-5-M95x2	251,00
M95x3	29-2-M95x3	132,00	29-3-M95x3	124,00	29-4-M95x3	276,00	29-5-M95x3	276,00
M95x4	29-2-M95x4	143,00	29-3-M95x4	136,00	29-4-M95x4	295,00	29-5-M95x4	295,00
M95x6	29-2-M95x6	168,00	29-3-M95x6	159,00	29-4-M95x6	353,00	29-5-M95x6	353,00
M98x1,5	29-2-M98x1,5	199,00	29-3-M98x1,5	191,00	29-4-M98x1,5	327,00	29-5-M98x1,5	327,00
M98x2	29-2-M98x2	118,00	29-3-M98x2	112,00	29-4-M98x2	261,00	29-5-M98x2	261,00
M100x1	29-2-M100x1	189,00	29-3-M100x1	189,00	29-4-M100x1	409,00	29-5-M100x1	409,00
M100x1,5	29-2-M100x1,5	119,00	29-3-M100x1,5	111,00	29-4-M100x1,5	259,00	29-5-M100x1,5	259,00
M100x2	29-2-M100x2	122,00	29-3-M100x2	115,00	29-4-M100x2	268,00	29-5-M100x2	268,00
M100x3	29-2-M100x3	137,00	29-3-M100x3	129,00	29-4-M100x3	298,00	29-5-M100x3	298,00
M100x4	29-2-M100x4	148,00	29-3-M100x4	141,00	29-4-M100x4	317,00	29-5-M100x4	317,00
M100x6	29-2-M100x6	171,00	29-3-M100x6	162,00	29-4-M100x6	368,00	29-5-M100x6	368,00
M105x1,5	29-2-M105x1,5	125,00	29-3-M105x1,5	116,00	29-4-M105x1,5	271,00	29-5-M105x1,5	271,00
M105x2	29-2-M105x2	124,00	29-3-M105x2	117,00	29-4-M105x2	286,00	29-5-M105x2	286,00
M105x3	29-2-M105x3	147,00	29-3-M105x3	139,00	29-4-M105x3	322,00	29-5-M105x3	322,00
M105x4	29-2-M105x4	153,00	29-3-M105x4	146,00	29-4-M105x4	349,00	29-5-M105x4	349,00
M105x6	29-2-M105x6	176,00	29-3-M105x6	176,00	29-4-M105x6	389,00	29-5-M105x6	389,00
M110x1,5	29-2-M110x1,5	131,00	29-3-M110x1,5	121,00	29-4-M110x1,5	282,00	29-5-M110x1,5	282,00
M110x2	29-2-M110x2	128,00	29-3-M110x2	119,00	29-4-M110x2	305,00	29-5-M110x2	305,00

Gewinde-Lehren M Feingewinde (Fortsetzung) Thread gauges metric fine (continuation)

für metrische ISO-Feingewinde nach DIN 13 (rechts) | Toleranz: Dorne 6H, Ringe 6g | aus gehärtetem Lehenstahl
for ISO fine metric thread according to DIN 13 (right) | tolerance: plug gauges 6H, ring gauges 6g | from hardened steel

Gewinde thread	Gut-Lehrdorn plug gauge (GO)		Ausschuss-Lehrdorn plug gauge (NOGO)		Gut-Lehrring ring gauge (GO)		Ausschuss-Lehrring ring gauge (NOGO)	
	Art.-Nr. Order no.	EUR	Art.-Nr. Order no.	EUR	Art.-Nr. Order no.	EUR	Art.-Nr. Order no.	EUR
M110x3	29-2-M110x3	153,00	29-3-M110x3	145,00	29-4-M110x3	338,00	29-5-M110x3	338,00
M110x4	29-2-M110x4	159,00	29-3-M110x4	152,00	29-4-M110x4	363,00	29-5-M110x4	363,00
M110x6	29-2-M110x6	179,00	29-3-M110x6	179,00	29-4-M110x6	398,00	29-5-M110x6	398,00
M115x1,5	29-2-M115x1,5	139,00	29-3-M115x1,5	139,00	29-4-M115x1,5	306,00	29-5-M115x1,5	306,00
M115x2	29-2-M115x2	133,00	29-3-M115x2	133,00	29-4-M115x2	317,00	29-5-M115x2	317,00
M115x3	29-2-M115x3	159,00	29-3-M115x3	159,00	29-4-M115x3	367,00	29-5-M115x3	367,00
M115x4	29-2-M115x4	165,00	29-3-M115x4	165,00	29-4-M115x4	391,00	29-5-M115x4	391,00
M115x6	29-2-M115x6	184,00	29-3-M115x6	184,00	29-4-M115x6	414,00	29-5-M115x6	414,00
M120x1,5	29-2-M120x1,5	146,00	29-3-M120x1,5	146,00	29-4-M120x1,5	312,00	29-5-M120x1,5	312,00
M120x2	29-2-M120x2	139,00	29-3-M120x2	139,00	29-4-M120x2	329,00	29-5-M120x2	329,00
M120x3	29-2-M120x3	163,00	29-3-M120x3	163,00	29-4-M120x3	393,00	29-5-M120x3	393,00
M120x4	29-2-M120x4	169,00	29-3-M120x4	169,00	29-4-M120x4	408,00	29-5-M120x4	408,00
M120x6	29-2-M120x6	189,00	29-3-M120x6	189,00	29-4-M120x6	455,00	29-5-M120x6	455,00
M125x1,5	29-2-M125x1,5	153,00	29-3-M125x1,5	153,00	29-4-M125x1,5	327,00	29-5-M125x1,5	327,00
M125x2	29-2-M125x2	148,00	29-3-M125x2	148,00	29-4-M125x2	343,00	29-5-M125x2	343,00
M125x3	29-2-M125x3	168,00	29-3-M125x3	168,00	29-4-M125x3	414,00	29-5-M125x3	414,00
M125x4	29-2-M125x4	171,00	29-3-M125x4	171,00	29-4-M125x4	419,00	29-5-M125x4	419,00
M125x6	29-2-M125x6	198,00	29-3-M125x6	198,00	29-4-M125x6	469,00	29-5-M125x6	469,00
M130x1,5	29-2-M130x1,5	158,00	29-3-M130x1,5	158,00	29-4-M130x1,5	337,00	29-5-M130x1,5	337,00
M130x2	29-2-M130x2	155,00	29-3-M130x2	155,00	29-4-M130x2	358,00	29-5-M130x2	358,00
M130x3	29-2-M130x3	179,00	29-3-M130x3	179,00	29-4-M130x3	422,00	29-5-M130x3	422,00
M130x4	29-2-M130x4	174,00	29-3-M130x4	174,00	29-4-M130x4	437,00	29-5-M130x4	437,00
M130x6	29-2-M130x6	212,00	29-3-M130x6	212,00	29-4-M130x6	484,00	29-5-M130x6	484,00
M135x1,5	29-2-M135x1,5	161,00	29-3-M135x1,5	161,00	29-4-M135x1,5	348,00	29-5-M135x1,5	348,00
M135x2	29-2-M135x2	161,00	29-3-M135x2	161,00	29-4-M135x2	378,00	29-5-M135x2	378,00
M135x3	29-2-M135x3	184,00	29-3-M135x3	184,00	29-4-M135x3	444,00	29-5-M135x3	444,00
M135x4	29-2-M135x4	177,00	29-3-M135x4	177,00	29-4-M135x4	453,00	29-5-M135x4	453,00
M135x6	29-2-M135x6	223,00	29-3-M135x6	223,00	29-4-M135x6	499,00	29-5-M135x6	499,00
M140x1,5	29-2-M140x1,5	169,00	29-3-M140x1,5	169,00	29-4-M140x1,5	363,00	29-5-M140x1,5	363,00
M140x2	29-2-M140x2	166,00	29-3-M140x2	166,00	29-4-M140x2	394,00	29-5-M140x2	394,00
M140x3	29-2-M140x3	189,00	29-3-M140x3	189,00	29-4-M140x3	468,00	29-5-M140x3	468,00
M140x4	29-2-M140x4	179,00	29-3-M140x4	179,00	29-4-M140x4	481,00	29-5-M140x4	481,00
M140x6	29-2-M140x6	235,00	29-3-M140x6	235,00	29-4-M140x6	527,00	29-5-M140x6	527,00
M145x1,5	29-2-M145x1,5	173,00	29-3-M145x1,5	173,00	29-4-M145x1,5	374,00	29-5-M145x1,5	374,00
M145x2	29-2-M145x2	173,00	29-3-M145x2	173,00	29-4-M145x2	404,00	29-5-M145x2	404,00
M145x3	29-2-M145x3	193,00	29-3-M145x3	193,00	29-4-M145x3	484,00	29-5-M145x3	484,00
M145x4	29-2-M145x4	182,00	29-3-M145x4	182,00	29-4-M145x4	498,00	29-5-M145x4	498,00
M145x6	29-2-M145x6	245,00	29-3-M145x6	245,00	29-4-M145x6	548,00	29-5-M145x6	548,00
M150x1,5	29-2-M150x1,5	176,00	29-3-M150x1,5	176,00	29-4-M150x1,5	394,00	29-5-M150x1,5	394,00
M150x2	29-2-M150x2	179,00	29-3-M150x2	179,00	29-4-M150x2	425,00	29-5-M150x2	425,00
M150x3	29-2-M150x3	228,00	29-3-M150x3	228,00	29-4-M150x3	498,00	29-5-M150x3	498,00
M150x4	29-2-M150x4	195,00	29-3-M150x4	195,00	29-4-M150x4	522,00	29-5-M150x4	522,00
M150x6	29-2-M150x6	273,00	29-3-M150x6	273,00	29-4-M150x6	595,00	29-5-M150x6	595,00

Weitere Größen auf Anfrage!
Further sizes on request!



Lehren, Einstellringe

Gauges, setting rings

Grenzlehrdorne für metrische Gewidekernlöcher *Limit plug gauges for metric thread core hole*

Grenzlehrdorn nach DIN 2245 für metrische Gewidekernlöcher nach DIN 13 6H | Lehrenmaße nach DIN ISO 1502 | aus gehärtetem Lehrenstahl
Limit plug gauge according to DIN 2245 for metric thread core holes according to DIN 13 6H | dimensions according to DIN ISO 1502 | from hardened steel



Regelgewinde <i>standard metric thread</i>		
Art.-Nr. <i>Order no.</i>	Gewinde <i>thread</i>	EUR
28-603	M3 (x0,5)	49,00
28-6035	M3,5 (x0,6)	49,00
28-604	M4 (x0,7)	49,00
28-6045	M4,5 (x0,75)	44,50
28-605	M5 (x0,8)	44,50
28-606	M6 (x1)	44,50
28-607	M7 (x1)	44,50
28-608	M8 (x1,25)	44,50
28-609	M9 (x1,25)	44,50
28-610	M10 (x1,5)	45,50
28-611	M11 (x1,5)	45,50
28-612	M12 (x1,75)	45,50
28-614	M14 (x2)	46,50
28-616	M16 (x2)	47,00
28-618	M18 (x2,5)	51,00
28-620	M20 (x2,5)	54,00
28-624	M24 (x3)	69,00

Feingewinde <i>metric fine thread</i>					
Art.-Nr. <i>Order no.</i>	Gewinde <i>thread</i>	EUR	Art.-Nr. <i>Order no.</i>	Gewinde <i>thread</i>	EUR
28-651	M4x0,5	49,00	28-675	M8x1	44,50
28-653	M5x0,5	44,50	28-677	M10x1	45,50
28-654	M6x0,5	44,50	28-679	M12x1	45,50
28-656	M8x0,5	44,50	28-681	M14x1	46,50
28-658	M10x0,5	45,50	28-682	M15x1	49,00
28-660	M12x0,5	46,50	28-683	M16x1	51,00
			28-685	M18x1	52,50
28-662	M5x0,75	44,50	28-687	M20x1	57,00
28-663	M6x0,75	44,50			
28-665	M8x0,75	44,50	28-689	M12x1,5	45,50
28-667	M10x0,75	45,50	28-691	M14x1,5	46,50
28-669	M12x0,75	46,50	28-692	M15x1,5	48,50
28-671	M14x0,75	47,50	28-693	M16x1,5	48,50
28-672	M15x0,75	49,00	28-695	M18x1,5	52,00
28-673	M16x0,75	51,00	28-696	M20x1,5	55,00
			28-697	M22x1,5	57,50
			28-698	M24x1,5	59,50

Weitere Gewinde auf Anfrage!
Further threads on request!



Anwendungshinweis: Zur Prüfung des fertigen Gewindes! Die Gutseite muss sich ohne besondere Kraft durch das Gewinde führen lassen, die Ausschußseite darf sich maximal einen Gewindegang (1x Gewindesteigung P) einführen lassen!

Information for use: For Testing the finished thread! The GO side has to go easily through the thread, the NOGO side is only allowed to go into the thread for maximum a single thread pitch!

Gewinde-Lehrdorne EG (Helicoil®) *Thread plug gauges EG (Helicoil®)*

für Gewindedrahteinsätze für metrische ISO-Gewinde nach DIN 8140 (Tol. 6H mod) oder amerikanische UNC/UNF-Gewinde (Tol. 2B) | gehärteter Lehrenstahl
for wire thread inserts for ISO metric screw threads according to DIN 8140 (Tol. 6H mod) or American UNC/UNF threads (Tol. 2B) | from hardened steel



Art.-Nr. <i>Order no.</i>	Gewinde <i>thread</i>	EUR	Art.-Nr. <i>Order no.</i>	Gewinde <i>thread</i>	EUR	Art.-Nr. <i>Order no.</i>	Gewinde <i>thread</i>	EUR	Art.-Nr. <i>Order no.</i>	Gewinde <i>thread</i>	EUR
28-302	EG M2	98,00	28-330	EG M8x1	67,00	28-350	EG UNC Nr.2	129,00	28-370	EG UNF Nr.4	104,00
28-3025	EG M2,5	89,00	28-331	EG M10x1	73,00	28-351	EG UNC Nr.4	101,00	28-371	EG UNF Nr.6	92,00
28-303	EG M3	81,50	28-332	EG M10x1,25	73,00	28-352	EG UNC Nr.5	97,00	28-372	EG UNF Nr.8	87,00
28-304	EG M4	57,00	28-333	EG M12x1,5	76,00	28-353	EG UNC Nr.6	91,00	28-373	EG UNF Nr.10	82,00
28-305	EG M5	55,50	28-334	EG M14x1,5	79,50	28-354	EG UNC Nr.8	83,00	28-374	EG UNF Nr.12	82,00
28-306	EG M6	55,50	28-335	EG M16x1,5	86,00	28-355	EG UNC Nr.10	81,00	28-375	EG UNF ¼"	82,00
28-308	EG M8	57,00	28-336	EG M18x1,5	92,00	28-356	EG UNC Nr.12	81,00	28-376	EG UNF 5/16"	87,00
28-310	EG M10	59,50	28-337	EG M20x1,5	97,00	28-357	EG UNC ¼"	78,00	28-377	EG UNF 3/8"	92,00
28-312	EG M12	68,50	28-338	EG M22x1,5	102,00	28-358	EG UNC 5/16"	83,00	28-378	EG UNF 7/16"	97,00
28-314	EG M14	79,50	28-339	EG M24x1,5	108,00	28-359	EG UNC 3/8"	90,00	28-379	EG UNF ½"	102,00
28-316	EG M16	86,00				28-360	EG UNC ½"	101,00	28-380	EG UNF 5/8"	123,00
28-318	EG M18	92,00				28-361	EG UNC 5/8"	129,00			
28-320	EG M20	98,00									

Weitere Größen auf Anfrage!
Further sizes on request!

Lehren, Einstellringe

Gauges, setting rings

Gewinde-Lehren UNC/UNF/UNEF Thread gauges UNC/UNF/UNEF

für UNC/UNF/UNEF-Gewinde nach ANSI/ASME B1.1/B1.2 | Toleranz: Dorne
2B, Ringe 2A | aus gehärtetem Lehrenstahl | eingravierte Bezeichnung
for threads UNC/UNF/UNEF according to ANSI/ASME B1.1/B1.2 | tolerance:
plug gauges 2B, ring gauges 2A | from hardened steel | size engraved



UNC	Lehrdorn plug gauge		Gut-Lehring ring gauge (GO)		Aussch.-Lehring ring gauge (NOGO)	
	Art.-Nr. Order no.	EUR	Art.-Nr. Order no.	EUR	Art.-Nr. Order no.	EUR
Nr.1 x 64	28-101	99,50	28-201	83,50	28-201A	83,50
Nr.2 x 56	28-102	75,00	28-202	66,50	28-202A	66,50
Nr.3 x 48	28-103	75,00	28-203	76,00	28-203A	76,00
Nr.4 x 40	28-104	52,50	28-204	52,50	28-204A	52,50
Nr.5 x 40	28-105	45,50	28-205	45,50	28-205A	45,50
Nr.6 x 32	28-106	44,00	28-206	43,00	28-206A	43,00
Nr.8 x 32	28-107	43,00	28-207	42,00	28-207A	42,00
Nr.10 x 24	28-108	42,00	28-208	41,50	28-208A	41,50
Nr.12 x 24	28-109	41,00	28-209	41,50	28-209A	41,50
1/4" x 20	28-111	39,50	28-210	41,50	28-210A	41,50
5/16" x 18	28-112	42,50	28-211	42,50	28-211A	42,50
3/8" x 16	28-113	44,00	28-212	44,00	28-212A	44,00
7/16" x 14	28-114	45,50	28-213	47,00	28-213A	47,00
1/2" x 13	28-115	47,00	28-214	51,00	28-214A	51,00
9/16" x 12	28-116	48,50	28-215	55,00	28-215A	55,00
5/8" x 11	28-117	56,00	28-216	61,00	28-216A	61,00
3/4" x 10	28-118	60,00	28-217	69,50	28-217A	69,50
7/8" x 9	28-119	69,50	28-218	85,00	28-218A	85,00
1" x 8	28-120	79,00	28-219	99,00	28-219A	99,00
1.1/8" x 7	28-121	94,00	28-220	114,00	28-220A	114,00
1.1/4" x 7	28-122	109,00	28-221	119,00	28-221A	119,00
1.3/8" x 6	28-123	114,00	28-222	133,00	28-222A	133,00
1.1/2" x 6	28-124	123,00	28-223	143,00	28-223A	143,00
1.3/4" x 5	28-125*	107,00	28-224	214,00	28-224A	214,00
	28-125A*	107,00				
2" x 4,5	28-126*	111,00	28-225	239,00	28-225A	239,00
	28-126A*	111,00				

*ab Größe 1.3/4" Gut- und Ausschusssdorn nur getrennt lieferbar!
(28-1...A = Ausschusssdorn)
From size 1.3/4" GO and NOGO plug gauge only available separately!
(28-1...A = NOGO plug gauge)

Weitere Größen auf Anfrage!
Further sizes on request!

UNF	Lehrdorn plug gauge		Gut-Lehring ring gauge (GO)		Aussch.-Lehring ring gauge (NOGO)	
	Art.-Nr. Order no.	EUR	Art.-Nr. Order no.	EUR	Art.-Nr. Order no.	EUR
Nr.0 x 80	28-131	94,50	28-231	97,50	28-231A	97,50
Nr.1 x 72	28-132	82,50	28-232	81,50	28-232A	81,50
Nr.2 x 64	28-133	92,50	28-233	76,50	28-233A	76,50
Nr.3 x 56	28-134	86,50	28-234	76,50	28-234A	76,50
Nr.4 x 48	28-135	55,00	28-235	53,50	28-235A	53,50
Nr.5 x 44	28-136	48,00	28-236	45,50	28-236A	45,50
Nr.6 x 40	28-137	46,00	28-237	43,50	28-237A	43,50
Nr.8 x 36	28-138	44,50	28-238	43,50	28-238A	43,50
Nr.10 x 32	28-139	43,50	28-239	42,00	28-239A	42,00
Nr.12 x 28	28-140	42,50	28-240	42,00	28-240A	42,00
1/4" x 28	28-141	41,50	28-241	42,00	28-241A	42,00
5/16" x 24	28-142	42,50	28-242	42,00	28-242A	42,00
3/8" x 24	28-143	43,50	28-243	44,00	28-243A	44,00
7/16" x 20	28-144	45,00	28-244	46,00	28-244A	46,00
1/2" x 20	28-145	47,50	28-245	49,50	28-245A	49,50
9/16" x 18	28-146	49,50	28-246	55,00	28-246A	55,00
5/8" x 18	28-147	53,00	28-247	61,00	28-247A	61,00
3/4" x 16	28-148	56,50	28-248	69,00	28-248A	69,00
7/8" x 14	28-149	58,50	28-249	81,00	28-249A	81,00
1" x 12	28-150	61,50	28-250	92,00	28-250A	92,00
1.1/8" x 12	28-151	73,50	28-251	103,00	28-251A	103,00
1.1/4" x 12	28-152	91,50	28-252	115,00	28-252A	115,00
1.3/8" x 12	28-153	101,00	28-253	123,00	28-253A	123,00
1.1/2" x 12	28-154	109,00	28-254	134,00	28-254A	134,00

UNEF	Lehrdorn plug gauge		Gut-Lehring ring gauge (GO)		Aussch.-Lehring ring gauge (NOGO)	
	Art.-Nr. Order no.	EUR	Art.-Nr. Order no.	EUR	Art.-Nr. Order no.	EUR
Nr.12 x 32	28-171	48,50	28-271	49,50	28-271A	49,50
1/4" x 32	28-172	49,50	28-272	49,50	28-272A	49,50
5/16" x 32	28-173	51,00	28-273	52,00	28-273A	52,00
3/8" x 32	28-174	52,50	28-274	54,00	28-274A	54,00
7/16" x 28	28-175	54,00	28-275	56,00	28-275A	56,00
1/2" x 28	28-176	56,00	28-276	58,00	28-276A	58,00
9/16" x 24	28-177	58,00	28-277	63,00	28-277A	63,00
5/8" x 24	28-178	62,50	28-278	71,50	28-278A	71,50
11/16" x 24	28-179	68,00	28-279	76,50	28-279A	76,50
3/4" x 20	28-180	70,00	28-280	79,50	28-280A	79,50
13/16" x 20	28-181	72,00	28-281	85,00	28-281A	85,00
7/8" x 20	28-182	74,00	28-282	91,00	28-282A	91,00
15/16" x 20	28-183	76,00	28-283	94,00	28-283A	94,00
1" x 20	28-184	78,00	28-284	99,00	28-284A	99,00
1.1/16" x 18	28-185	99,00	28-285	126,00	28-285A	126,00
1.1/8" x 18	28-186	106,00	28-286	132,00	28-286A	132,00
1.1/4" x 18	28-188	117,00	28-288	148,00	28-288A	148,00
1.3/8" x 18	28-190	130,00	28-290	159,00	28-290A	159,00
1.1/2" x 18	28-192	144,00	28-292	165,00	28-292A	165,00

Lehren, Einstellringe Gauges, setting rings

Gewinde-Lehren UN Thread gauges UN

für UN-Gewinde nach ANSI/ASME B1.1/B1.2 | Toleranz: Dorne 2B, Ringe 2A | aus gehärtetem Lehenstahl | eingravierte Bezeichnung
for threads UN according to ANSI/ASME B1.1/B1.2 | tolerance: plug gauges 2B, ring gauges 2A | from hardened steel | size engraved



Gewinde thread	Lehrdorn plug gauge		Gut-Lehrdorn plug gauge (GO)		Ausschuss-Lehrdorn plug gauge (NOGO)		Gut-Lehrring ring gauge (GO)		Ausschuss-Lehrring ring gauge (NOGO)	
	Art.-Nr. Order no.	EUR	Art.-Nr. Order no.	EUR	Art.-Nr. Order no.	EUR	Art.-Nr. Order no.	EUR	Art.-Nr. Order no.	EUR
1.1/8" x 8	29-UN-102	149,00					29-UN-402	156,00	29-UN-502	156,00
1.1/4" x 8	29-UN-104	155,00					29-UN-404	164,00	29-UN-504	164,00
1.3/8" x 8	29-UN-106	161,00					29-UN-406	168,00	29-UN-506	168,00
1.1/2" x 8	29-UN-108	167,00					29-UN-408	179,00	29-UN-508	179,00
1.5/8" x 8			29-UN-210	103,00	29-UN-310	103,00	29-UN-410	184,00	29-UN-510	184,00
1.3/4" x 8			29-UN-212	112,00	29-UN-312	112,00	29-UN-412	194,00	29-UN-512	194,00
1.7/8" x 8			29-UN-214	117,00	29-UN-314	117,00	29-UN-414	199,00	29-UN-514	199,00
2" x 8			29-UN-216	126,00	29-UN-316	126,00	29-UN-416	210,00	29-UN-516	210,00
2.1/4" x 8			29-UN-218	133,00	29-UN-318	133,00	29-UN-418	261,00	29-UN-518	261,00
2.1/2" x 8			29-UN-220	143,00	29-UN-320	143,00	29-UN-420	271,00	29-UN-520	271,00
2.3/4" x 8			29-UN-222	154,00	29-UN-322	154,00	29-UN-422	284,00	29-UN-522	284,00
3" x 8			29-UN-224	169,00	29-UN-324	169,00	29-UN-424	322,00	29-UN-524	322,00
1.1/16" x 12	29-UN-137	119,00					29-UN-437	121,00	29-UN-537	121,00
1.3/16" x 12	29-UN-138	121,00					29-UN-438	125,00	29-UN-538	125,00
1.5/16" x 12	29-UN-139	126,00					29-UN-439	131,00	29-UN-539	131,00
1.7/16" x 12	29-UN-140	131,00					29-UN-440	137,00	29-UN-540	137,00
1.5/8" x 12			29-UN-242	86,00	29-UN-342	86,00	29-UN-442	142,00	29-UN-542	142,00
1.3/4" x 12			29-UN-244	93,00	29-UN-344	93,00	29-UN-444	152,00	29-UN-544	152,00
1.7/8" x 12			29-UN-246	99,00	29-UN-346	99,00	29-UN-446	159,00	29-UN-546	159,00
2" x 12			29-UN-247	105,00	29-UN-347	105,00	29-UN-447	166,00	29-UN-547	166,00
2.1/4" x 12			29-UN-249	112,00	29-UN-349	112,00	29-UN-449	199,00	29-UN-549	199,00
2.1/2" x 12			29-UN-251	122,00	29-UN-351	122,00	29-UN-451	208,00	29-UN-551	208,00
2.3/4" x 12			29-UN-253	131,00	29-UN-353	131,00	29-UN-453	215,00	29-UN-553	215,00
3" x 12			29-UN-255	140,00	29-UN-355	140,00	29-UN-455	238,00	29-UN-555	238,00
11/16" x 16	29-UN-175	99,00					29-UN-475	107,00	29-UN-575	107,00
13/16" x 16	29-UN-176	104,00					29-UN-476	112,00	29-UN-576	112,00
7/8" x 16	29-UN-177	107,00					29-UN-477	117,00	29-UN-577	117,00
15/16" x 16	29-UN-178	112,00					29-UN-478	119,00	29-UN-578	119,00
1" x 16	29-UN-179	116,00					29-UN-479	122,00	29-UN-579	122,00
1.1/16" x 16	29-UN-180	119,00					29-UN-480	125,00	29-UN-580	125,00
1.1/8" x 16	29-UN-181	122,00					29-UN-481	128,00	29-UN-581	128,00
1.3/16" x 16	29-UN-182	125,00					29-UN-482	131,00	29-UN-582	131,00
1.1/4" x 16	29-UN-183	128,00					29-UN-483	134,00	29-UN-583	134,00
1.1/2" x 16	29-UN-187	139,00					29-UN-487	146,00	29-UN-587	146,00
1.3/4" x 16			29-UN-291	87,00	29-UN-391	87,00	29-UN-491	158,00	29-UN-591	158,00
2" x 16			29-UN-295	99,00	29-UN-395	99,00	29-UN-495	169,00	29-UN-595	169,00

Weitere Größen auf Anfrage!
Further sizes on request!

Lehren, Einstellringe

Gauges, setting rings

Gewinde-Lehren UNJC/UNJF Thread gauges UNJC/UNJF

für UNJC/UNJF-Gewinde nach ISO 3161, ANSI/ASME B1.2 | Toleranz: Dorne 3B, Ringe 3A | aus gehärtetem Lehenstahl | eingravierte Bezeichnung
for threads UNJC/UNJF according to ISO 3161, ANSI/ASME B1.2 | tolerance: plug gauges 3B, ring gauges 3A | from hardened steel | size engraved



UNJC	Lehrdorn plug gauge (GO+NOGO)		Gut-Lehrring ring gauge (GO)		Ausschuss-Lehrring ring gauge (NOGO)	
	Art.-Nr. Order no.	EUR	Art.-Nr. Order no.	EUR	Art.-Nr. Order no.	EUR
Nr.2 x 56	29-UNJC-101	109,00	29-UNJC-401	124,00	29-UNJC-501	124,00
Nr.4 x 40	29-UNJC-102	93,00	29-UNJC-402	104,00	29-UNJC-502	104,00
Nr.6 x 32	29-UNJC-103	85,00	29-UNJC-403	90,00	29-UNJC-503	90,00
Nr.8 x 32	29-UNJC-104	79,00	29-UNJC-404	82,00	29-UNJC-504	82,00
Nr.10 x 24	29-UNJC-105	79,00	29-UNJC-405	82,00	29-UNJC-505	82,00
1/4" x 20	29-UNJC-106	79,00	29-UNJC-406	82,00	29-UNJC-506	82,00
5/16" x 18	29-UNJC-107	79,00	29-UNJC-407	82,00	29-UNJC-507	82,00
3/8" x 16	29-UNJC-108	79,00	29-UNJC-408	86,00	29-UNJC-508	86,00
7/16" x 14	29-UNJC-109	99,00	29-UNJC-409	109,00	29-UNJC-509	109,00

UNJF	Lehrdorn plug gauge (GO+NOGO)		Gut-Lehrring ring gauge (GO)		Ausschuss-Lehrring ring gauge (NOGO)	
	Art.-Nr. Order no.	EUR	Art.-Nr. Order no.	EUR	Art.-Nr. Order no.	EUR
Nr.4 x 48	29-UNJF-101	78,00	29-UNJF-401	83,00	29-UNJF-501	83,00
Nr.6 x 40	29-UNJF-102	71,00	29-UNJF-402	74,00	29-UNJF-502	74,00
Nr.8 x 36	29-UNJF-103	68,00	29-UNJF-403	69,00	29-UNJF-503	69,00
Nr.10 x 32	29-UNJF-104	59,50	29-UNJF-404	69,00	29-UNJF-504	69,00
Nr.12 x 28	29-UNJF-105	65,00	29-UNJF-405	69,00	29-UNJF-505	69,00
1/4" x 28	29-UNJF-106	65,00	29-UNJF-406	69,00	29-UNJF-506	69,00
5/16" x 24	29-UNJF-107	65,00	29-UNJF-407	69,00	29-UNJF-507	69,00
3/8" x 24	29-UNJF-108	67,00	29-UNJF-408	71,00	29-UNJF-508	71,00
7/16" x 20	29-UNJF-109	67,00	29-UNJF-409	74,00	29-UNJF-509	74,00
1/2" x 20	29-UNJF-110	70,00	29-UNJF-410	78,00	29-UNJF-510	78,00
9/16" x 18	29-UNJF-111	73,00	29-UNJF-411	82,00	29-UNJF-511	82,00
5/8" x 18	29-UNJF-112	88,00	29-UNJF-412	91,00	29-UNJF-512	91,00
3/4" x 16	29-UNJF-113	92,00	29-UNJF-413	99,00	29-UNJF-513	99,00
7/8" x 14	29-UNJF-114	97,00	29-UNJF-414	106,00	29-UNJF-514	106,00
1" x 12	29-UNJF-115	99,00	29-UNJF-415	114,00	29-UNJF-515	114,00

Weitere Größen auf Anfrage!
Further sizes on request!



Hinweise zum Nenn Durchmesser (gültig für UNC/UNF/UNEF/UN/UNJC/UNJF):
Information about nominal size (valid for UNC/UNF/UNEF/UN/UNJC/UNJF):

Nr.	Ø inch	Ø mm	Nr.	Ø inch	Ø mm	Nr.	Ø inch	Ø mm	Nr.	Ø inch	Ø mm
Nr.0	0,060	1,524	Nr.5	0,125	3,175	1/4"	0,250	6,350	9/16"	0,563	14,288
Nr.1	0,073	1,854	Nr.6	0,138	3,505	5/16"	0,313	7,938	5/8"	0,625	15,875
Nr.2	0,086	2,184	Nr.8	0,164	4,166	3/8"	0,375	9,525	3/4"	0,750	19,050
Nr.3	0,099	2,515	Nr.10	0,190	4,826	7/16"	0,438	11,113	7/8"	0,875	22,225
Nr.4	0,112	2,845	Nr.12	0,216	5,486	1/2"	0,500	12,700	1"	1,000	25,400



Lehren, Einstellringe Gauges, setting rings

Gewinde-Lehren G (Whitworth) Thread gauges G (Whitworth)

für zylindrische Whitworth-Rohrgewinde (nicht im Gewinde dichtend) nach DIN EN ISO 228 | Toleranz Dorne: medium, Toleranz Ringe: A |
Flankenwinkel 55° | aus gehärtetem Lehenstahl | eingravierte Bezeichnung

for cylindric Whitworth pipe threads (non-sealing in thread) according to DIN EN ISO 228 | tolerance plug gauges: medium, tolerance ring gauges: A |
flank angle 55° | from hardened steel | size engraved



Gewinde thread	Ø* (mm)	Lehrdorn plug gauge		Gut-Lehrdorn plug gauge (GO)		Ausschuss-Lehrdorn plug gauge (NOGO)		Gut-Lehrring ring gauge (GO)		Ausschuss-Lehrring ring gauge (NOGO)	
		Art.-Nr. Order no.	EUR	Art.-Nr. Order no.	EUR	Art.-Nr. Order no.	EUR	Art.-Nr. Order no.	EUR	Art.-Nr. Order no.	EUR
G1/16" x 28	7,723	29-G-101	75,00					29-G-401	85,50	29-G-501	85,50
G1/8" x 28	9,728	29-G-102	49,00					29-G-402	44,80	29-G-502	44,80
G1/4" x 19	13,157	29-G-103	53,00					29-G-403	53,00	29-G-503	53,00
G3/8" x 19	16,662	29-G-104	56,50					29-G-404	56,50	29-G-504	56,50
G1/2" x 14	20,955	29-G-105	64,00					29-G-405	66,50	29-G-505	66,50
G5/8" x 14	22,911	29-G-106	71,50					29-G-406	79,50	29-G-506	79,50
G3/4" x 14	26,441	29-G-107	74,50					29-G-407	83,50	29-G-507	83,50
G7/8" x 14	30,201	29-G-108	84,50					29-G-408	96,00	29-G-508	96,00
G1" x 11	33,249	29-G-109	92,00					29-G-409	101,00	29-G-509	101,00
G1.1/8" x 11	37,897	29-G-110	109,00					29-G-410	121,00	29-G-510	121,00
G1 1/4" x 11	41,910			29-G-211	63,00	29-G-311	63,00	29-G-411	126,00	29-G-511	126,00
G1 1/2" x 11	47,803			29-G-212	68,00	29-G-312	68,00	29-G-412	141,00	29-G-512	141,00
G1 3/4" x 11	53,746			29-G-213	77,50	29-G-313	77,50	29-G-413	158,00	29-G-513	158,00
G2" x 11	59,614			29-G-214	81,50	29-G-314	81,50	29-G-414	173,00	29-G-514	173,00
G2 1/4" x 11	65,710			29-G-215	91,00	29-G-315	91,00	29-G-415	192,00	29-G-515	192,00
G2 1/2" x 11	75,184			29-G-216	104,00	29-G-316	104,00	29-G-416	215,00	29-G-516	215,00
G2 3/4" x 11	81,534			29-G-217	119,00	29-G-317	119,00	29-G-417	234,00	29-G-517	234,00
G3" x 11	87,884			29-G-218	124,00	29-G-318	124,00	29-G-418	248,00	29-G-518	248,00
G3 1/2" x 11	100,330			29-G-219	142,00	29-G-319	142,00	29-G-419	311,00	29-G-519	311,00
G4" x 11	113,030			29-G-220	149,00	29-G-320	149,00	29-G-420	349,00	29-G-520	349,00
G4 1/2" x 11	125,730			29-G-221	225,00	29-G-321	225,00	29-G-421	471,00	29-G-521	471,00
G5" x 11	138,430			29-G-222	247,00	29-G-322	247,00	29-G-422	492,00	29-G-522	492,00
G5 1/2" x 11	151,130			29-G-223	302,00	29-G-323	302,00	29-G-423	635,00	29-G-523	635,00
G6" x 11	163,830			29-G-224	318,00	29-G-324	318,00	29-G-424	692,00	29-G-524	692,00

*Außendurchmesser *outside diameter*



Bei Gut-Lehrringen entspricht Toleranz A = Toleranz B, Ausschuss-Lehrringe mit Toleranz B auf Anfrage!
GO ring gauges with tolerance A are equal to tolerance B, NOGO ring gauges with tolerance B on request!

Lehren, Einstellringe Gauges, setting rings

Gewinde-Lehren R/Rp/Rc (Whitworth kegelig) Thread gauges R/Rp/Rc (Whitworth tapered)

für kegelige Whitworth-Rohrgewinde (im Gewinde dichtend) | Kegel 1:16 | aus gehärtetem Lehenstahl | eingravierte Bezeichnung
for conic Whitworth pipe threads (sealing in thread) | cone 1:16 | from hardened steel | size engraved



Hinweise zur Kennzeichnung:
Information about marking:

R	Lehrringe für kegelige Außengewinde Ring gauges for external taper threads
Rp	Lehrdorne für zylindrische Innengewinde Plug gauges for internal cylindrical threads
Rp/Rc	Lehrdorne für zylindrische und kegelige Innengewinde Plug gauges for internal cylindrical and taper threads

Gewinde thread	DIN 2999*				ISO 7 / DIN EN 10226*			
	Lehrdorn Rp plug gauge Rp		Lehrring R ring gauge R		Lehrdorn Rp/Rc plug gauge Rp/Rc		Lehrring R ring gauge R	
	Art.-Nr. Order no.	EUR	Art.-Nr. Order no.	EUR	Art.-Nr. Order no.	EUR	Art.-Nr. Order no.	EUR
1/8" x 28	29-600	144,00	29-610	102,00	29-620	159,00	29-630	115,00
1/4" x 19	29-601	152,00	29-611	110,00	29-621	169,00	29-631	123,00
3/8" x 19	29-602	165,00	29-612	132,00	29-622	183,00	29-632	148,00
1/2" x 14	29-603	179,00	29-613	158,00	29-623	198,00	29-633	177,00
3/4" x 14	29-604	199,00	29-614	181,00	29-624	221,00	29-634	203,00
1" x 11	29-605	235,00	29-615	195,00	29-625	260,00	29-635	218,00
1 1/4" x 11	29-606	279,00	29-616	231,00	29-626	310,00	29-636	259,00
1 1/2" x 11	29-607	315,00	29-617	283,00	29-627	349,00	29-637	315,00
2" x 11	29-608	387,00	29-618	316,00	29-628	428,00	29-638	353,00

*DIN 2999 wurde zwecks weltweiter Vereinheitlichung durch ISO 7/DIN EN 10226 ersetzt! Deshalb bei Bestellung bitte beachten, ob Lehren nach alter oder neuer Norm benötigt werden!

DIN 2999 was replaced by ISO 7/DIN EN 10226 due to worldwide unification!
Please take into consideration whether you need old or new standard!

Gewinde-Lehren BSW/BSF (British Standard Whitworth) Thread gauges BSW/BSF (British Standard Whitworth)

für BSW/BSF-Gewinde nach BS 84 / BS 919-2 | Toleranz: med. (medium class) | aus gehärtetem Lehenstahl | eingravierte Bezeichnung
for threads BSW/BSF according to BS 84 / BS 919-2 | tolerance: med. (medium class) | from hardened steel | size engraved



	Lehrdorn plug gauge (go+nogo)		Gut-Lehrring ring gauge (go)		Ausschuss-Lehrring ring gauge (no go)	
	Art.-Nr. Order no.	EUR	Art.-Nr. Order no.	EUR	Art.-Nr. Order no.	EUR
1/8" x 40	29-BSW-101	89,00	29-BSW-401	79,50	29-BSW-501	79,50
3/16" x 24	29-BSW-102	67,00	29-BSW-402	61,00	29-BSW-502	61,00
1/4" x 20	29-BSW-103	64,50	29-BSW-403	59,00	29-BSW-503	59,00
5/16" x 18	29-BSW-104	66,00	29-BSW-404	64,00	29-BSW-504	64,00
3/8" x 16	29-BSW-105	67,50	29-BSW-405	67,00	29-BSW-505	67,00
7/16" x 14	29-BSW-106	69,00	29-BSW-406	69,50	29-BSW-506	69,50
1/2" x 12	29-BSW-107	74,50	29-BSW-407	74,50	29-BSW-507	74,50
9/16" x 12	29-BSW-108	79,50	29-BSW-408	83,50	29-BSW-508	83,50
5/8" x 11	29-BSW-109	84,50	29-BSW-409	89,00	29-BSW-509	89,00
3/4" x 10	29-BSW-110	97,00	29-BSW-410	98,00	29-BSW-510	98,00
7/8" x 9	29-BSW-111	109,00	29-BSW-411	114,00	29-BSW-511	114,00
1" x 8	29-BSW-112	127,00	29-BSW-412	128,00	29-BSW-512	128,00
1 1/4" x 7	29-BSW-114	149,00	29-BSW-414	156,00	29-BSW-514	156,00
1 1/2" x 6	29-BSW-116	187,00	29-BSW-416	187,00	29-BSW-516	187,00
3/16" x 32	29-BSF-101	79,00	29-BSF-401	76,50	29-BSF-501	76,50
1/4" x 26	29-BSF-103	76,00	29-BSF-403	69,00	29-BSF-503	69,00
5/16" x 22	29-BSF-105	76,00	29-BSF-405	69,00	29-BSF-505	69,00
3/8" x 20	29-BSF-106	79,00	29-BSF-406	76,50	29-BSF-506	76,50
1/2" x 16	29-BSF-108	82,00	29-BSF-408	84,00	29-BSF-508	84,00
5/8" x 14	29-BSF-110	89,00	29-BSF-410	97,00	29-BSF-510	97,00
3/4" x 12	29-BSF-112	99,00	29-BSF-412	109,00	29-BSF-512	109,00
7/8" x 11	29-BSF-113	117,00	29-BSF-413	123,00	29-BSF-513	123,00
1" x 10	29-BSF-114	142,00	29-BSF-414	147,00	29-BSF-514	147,00

Weitere Größen auf Anfrage!
Further sizes on request!

Lehren, Einstellringe

Gauges, setting rings

Gewinde-Lehren NPT/NPTF Thread gauges NPT/NPTF

für kegelige NPT/NPTF-Rohrgewinde nach ANSI B1.20.1 (NPT) und ANSI B1.20.3 (NPTF) | Ausführung L1 (Lehrdorn und -ring mit Gut- und Ausschussstufe) | Kegel 1:16 | aus gehärtetem Lehenstahl | eingravierte Bezeichnung
 for conic NPT/NPTF pipe threads according to ANSI B1.20.1 (NPT) and ANSI B1.20.3 (NPTF) | Type L1 (Plug gauge and ring gauge with GO and NOGO step) | cone 1:16 | from hardened steel | size engraved



Anwendungshinweis:
 Information for use:

Das zu prüfende Gewinde ist in Ordnung, wenn nach Aufschrauben der Lehre das Gewinde-Ende zwischen Gut- und Ausschuss-Stufe liegt!
 The thread to be tested is OK, when the thread end is in between GO and NOGO step after screwing the gauge onto the thread!

Gewinde thread NPT	Lehrdorn plug gauge		Lehrring ring gauge		Gewinde thread NPTF	Lehrdorn plug gauge		Lehrring ring gauge	
	Art.-Nr. Order no.	EUR	Art.-Nr. Order no.	EUR		Art.-Nr. Order no.	EUR	Art.-Nr. Order no.	EUR
1/16" x 27	28-001	119,00	28-041	185,00	1/16" x 27	28-021	126,00	28-061	243,00
1/8" x 27	28-002	119,00	28-042	188,00	1/8" x 27	28-022	131,00	28-062	177,00
1/4" x 18	28-003	123,00	28-043	191,00	1/4" x 18	28-023	135,00	28-063	181,00
3/8" x 18	28-004	131,00	28-044	198,00	3/8" x 18	28-024	138,00	28-064	186,00
1/2" x 14	28-005	139,00	28-045	219,00	1/2" x 14	28-025	144,00	28-065	199,00
3/4" x 14	28-006	148,00	28-046	228,00	3/4" x 14	28-026	151,00	28-066	213,00
1" x 11,5	28-007	172,00	28-047	267,00	1" x 11,5	28-027	173,00	28-067	251,00
1 1/4" x 11,5	28-008	195,00	28-048	316,00	1 1/4" x 11,5	28-028	189,00	28-068	307,00
1 1/2" x 11,5	28-009	211,00	28-049	339,00	1 1/2" x 11,5	28-029	199,00	28-069	323,00
2" x 11,5	28-010	239,00	28-050	376,00	2" x 11,5	28-030	230,00	28-070	345,00
2 1/2" x 8	28-011	297,00	28-051	451,00	2 1/2" x 8	28-031	287,00	28-071	398,00
3" x 8	28-012	325,00	28-052	486,00	3" x 8	28-032	345,00	28-072	462,00
3 1/2" x 8	28-013	461,00	28-053	574,00					
4" x 8	28-014	575,00	28-054	745,00					

Gewinde-Lehren Pg (Stahlpanzerrohr-Gewinde) Thread gauges Pg (Machined Steel Pipe Thread)

für Stahlpanzerrohr-Gewinde nach DIN 40430 (Flankenwinkel 80°) | Ausschuss-Lehrdorn ohne Gewinde zur Prüfung des Mutter-Kerndurchmessers | Ausschuss-Lehrring ohne Gewinde zur Prüfung des Bolzen-Außendurchmessers | aus gehärtetem Lehenstahl | eingravierte Bezeichnung
 for Machined Steel Pipe Threads according to DIN 40430 (flank angle 80°) | NOGO-plug gauge without thread for testing of minor diameter | NOGO-ring gauge without thread for testing of major diameter | from hardened steel | size engraved



Gewinde thread	Lehrdorn plug gauge (go/no-go)		Gut-Lehrdorn plug gauge (go)		Ausschuss-Lehrdorn plug gauge (no go)		Gut-Lehrring ring gauge (go)		Ausschuss-Lehrring ring gauge (no go)	
	Art.-Nr. Order no.	EUR	Art.-Nr. Order no.	EUR	Art.-Nr. Order no.	EUR	Art.-Nr. Order no.	EUR	Art.-Nr. Order no.	EUR
Pg 7	28-901	58,50					28-920	86,00	28-930	37,80
Pg 9	28-902	65,00					28-921	94,00	28-931	41,50
Pg 11	28-903	73,50					28-922	103,00	28-932	44,50
Pg 13,5	28-904	79,50					28-923	111,00	28-933	46,50
Pg 16	28-905	84,50					28-924	117,00	28-934	48,50
Pg 21	28-906	99,00					28-925	143,00	28-935	51,50
Pg 29	28-907	133,00					28-926	182,00	28-936	53,00
Pg 36			28-911	119,00	28-916	66,50	28-927	223,00	28-937	61,00
Pg 42			28-912	136,00	28-917	75,50	28-928	252,00	28-938	75,50
Pg 48			28-913	148,00	28-918	82,00	28-929	276,00	28-939	79,50

Lehren, Einstellringe Gauges, setting rings

Gewinde-Lehren Tr (Trapez-Gewinde) Thread gauges Tr (Trapezoid Thread)

für metrische Trapez-Gewinde nach DIN 103 (Flankenwinkel 30°) | Toleranz Dorne: 7H, Toleranz Ringe: 7e | aus gehärtetem Lehrenstahl | eingravierte Bezeichnung

for metric trapezoid threads according to DIN 103 (flank angle 30°) | tolerance plug gauges: 7H, tolerance ring gauges: 7e | from hardened steel | size engraved



Gewinde thread	Steigung pitch	Lehrdorn plug gauge		Gut-Lehrring ring gauge (go)		Ausschuss-Lehrring ring gauge (no go)	
		Art.-Nr. Order no.	EUR	Art.-Nr. Order no.	EUR	Art.-Nr. Order no.	EUR
Tr 8	1,5	28-941	139,00	28-961	199,00	28-981	199,00
Tr 10	2	28-943	154,00	28-963	205,00	28-983	205,00
Tr 11	2	28-944	154,00	28-964	208,00	28-984	208,00
Tr 12	3	28-945	154,00	28-965	210,00	28-985	210,00
Tr 14	3	28-946	158,00	28-966	213,00	28-986	213,00
Tr 16	4	28-947	163,00	28-967	219,00	28-987	219,00
Tr 18	4	28-948	169,00	28-968	223,00	28-988	223,00
Tr 20	4	28-949	173,00	28-969	232,00	28-989	232,00
Tr 22	5	28-950	183,00	28-970	243,00	28-990	243,00
Tr 24	5	28-951	192,00	28-971	256,00	28-991	256,00
Tr 26	5	28-952	199,00	28-972	265,00	28-992	265,00
Tr 28	5	28-953	211,00	28-973	277,00	28-993	277,00
Tr 30	6	28-954	222,00	28-974	288,00	28-994	288,00
Tr 32	6	28-955	227,00	28-975	297,00	28-995	297,00

Weitere Größen auf Anfrage!
Further sizes on request!

Gewindeschablone Thread master plates

für metrische Gewinde 60° und Whitworth-Gewinde 55° | Etui
for metric threads 60° and Whitworth threads 55° | sheath

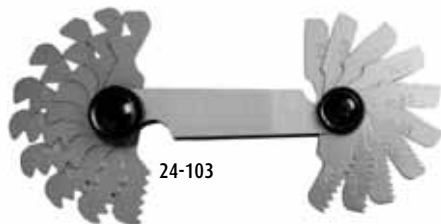

Art.-Nr. Order no.	Gewinde threads	EUR
24-103	60°: 24x Steigung pitch 0,25-6 mm	3,80
24-101	60°: 24x Steigung pitch 0,25-6 mm 55°: 28x Steigung pitch 4-62 TPI	5,90
24-102	60°: 24x Steigung pitch 0,25-6 mm 55°: 34x Steigung pitch 4-62 TPI	7,90

HELIOS-PREISSER Gewindeschablone Thread master plates

für unterschiedliche Gewinde erhältlich
for different threads available



Art.-Nr. Order no.	Gewinde threads	Anzahl Blätter number blades	Messbereich (Gewindesteigung) Range (pitch)	EUR
47-801	M	24	0,25 - 6 mm	2,50
47-803	G (Whitworth)	28	4 - 62 TPI	2,30
47-806	M / G (Whitworth)	52	0,25 - 6 mm / 4 - 62 TPI	3,60
47-810	UNC	22	4 - 64 TPI	3,00
47-811	UNF	16	12 - 80 TPI	3,00

Lehren, Einstellringe Gauges, setting rings

Grenzwellennutenlehre *Keyway limit gauge*

nach DIN 7162 / 7163 | aus gehärtetem Lehenstahl
according to DIN 7162 / 7163 | from hardened steel



28-543

Art.-Nr. Order no.	Nennmaß size	EUR
28-531	2,0 P9	98,50
28-532	3,0 P9	89,00
28-533	4,0 P9	89,00
28-534	5,0 P9	89,00
28-535	6,0 P9	93,00
28-536	8,0 P9	93,00
28-537	10,0 P9	98,50
28-538	12,0 P9	98,50
28-539	14,0 P9	105,00
28-540	16,0 P9	105,00
28-541	18,0 P9	114,00
28-542	20,0 P9	114,00
28-543	22,0 P9	129,00
28-544	24,0 P9	129,00
28-545	25,0 P9	129,00

Art.-Nr. Order no.	Nennmaß size	EUR
28-561	2,0 JS9	98,50
28-562	3,0 JS9	89,00
28-563	4,0 JS9	89,00
28-564	5,0 JS9	89,00
28-565	6,0 JS9	93,00
28-566	8,0 JS9	93,00
28-567	10,0 JS9	98,50
28-568	12,0 JS9	98,50
28-569	14,0 JS9	105,00
28-570	16,0 JS9	105,00
28-571	18,0 JS9	114,00
28-572	20,0 JS9	114,00
28-573	22,0 JS9	129,00
28-574	24,0 JS9	129,00
28-575	25,0 JS9	129,00

Weitere Größen und Passungen auf Anfrage!
Further sizes on request!

Messkeil *V-head*

Messbereich 0,5-11 mm | Ablesung 0,1 mm | Werkzeugstahl
Range 0.5-11 mm | reading 0.1 mm | tool steel



Art.-Nr. Order no.	EUR
24-011	19,50

HELIOS-PREISSER Messkeil *V-head*

Messbereich 0,5-11 mm | Ablesung 0,1 mm | Made in Germany
Range 0.5-11 mm | reading 0.1 mm | Made in Germany



46-911



Art.-Nr. Order no.	Material material	EUR
46-911	Spezialstahl, gehärtet special steel, hardened	47,50
46-914	Kunststoff plastics	47,50

Digital-Messkeil *Digital taper slot gauge*

Messbereich 0,5-31 mm (inkl. 2 Messbereicherweiterungsstücke) | Auflösung 0,001 mm
Range 0.5-31 mm (incl. 2 measuring range extensions) | reading 0.001 mm

Art.-Nr. Order no.	EUR
10-231	208,00



Messbereicherweiterungen:
measuring range extensions:



Lehren, Einstellringe

Gauges, setting rings

Fühlerlehre Feeler gauge

Länge 100 mm | Breite 12,7 mm, konisch | Etui
 Length 100 mm | Width 12.7 mm, conical | sheath

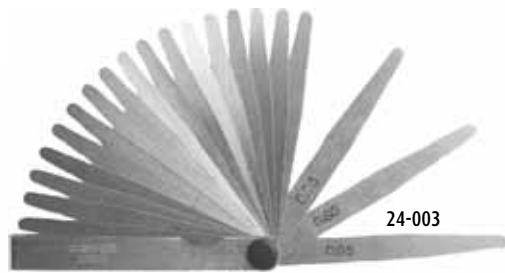

Art.-Nr. Order no.	Anzahl Blätter number blades	Messbereich (mm) Range (mm)	Genauigkeit Accuracy	EUR
24-001	8	0,03/0,04/0,05/0,06/0,07/0,08/0,09/0,10	12 µm	3,20
24-002	13	0,05/0,10/0,15/0,20/0,25/0,30/0,40/0,50/ 0,60/0,70/0,80/0,90/1,00	20 µm	2,60
24-003	20	0,05/0,10/0,15/0,20/0,25/ 0,30/0,35/0,40/0,45/0,50/ 0,55/0,60/0,65/0,70/0,75/ 0,80/0,85/0,90/0,95/1,00		3,90

HELIOS-PREISSER Präzisions-Fühlerlehre T3 Precision feeler gauge T3

Länge 100 mm | Breite 10 mm, konisch | Genauigkeit T3 | Federbandstahl | Etui
 Length 100 mm | Width 10 mm, tapered | Accuracy T3 | spring band steel | sheath



Art.-Nr. Order no.	Anzahl Blätter number blades	Messbereich (mm) Range (mm)	Genauigkeit Accuracy	EUR
46-933	13	0,05 - 1 mm	3 µm (0,05-0,06 mm)	4,60
46-935	20	0,05 - 1 mm	4 µm (0,07-0,12 mm) 5 µm (0,15-0,18 mm)	7,20
46-936	32	0,03 - 1 mm	6 µm (0,20-0,22 mm) 7 µm (0,25-0,30 mm) 8 µm (0,35-0,35 mm) 9 µm (0,40-0,45 mm) 10 µm (0,50-0,60 mm) 12 µm (0,70-0,70 mm) 13 µm (0,80-1,00 mm)	16,50

Präzisions-Fühlerlehre ab 0,01 mm Precision feeler gauge from 0.01 mm

Länge 100 mm | Breite 12,7 mm | Made in Japan | Etui
 Length 100 mm | Width 12.7 mm | Made in Japan | sheath



Art.-Nr. Order no.	Anzahl Blätter number blades	Messbereich (mm) Range (mm)	Genauigkeit Accuracy	EUR
24-000	10	0,01/0,02/0,03/0,04/0,05/ 0,06/0,07/0,08/0,09/0,10	5 µm (0,01-0,06 mm) 10 µm (0,07-0,10 mm)	16,50
24-007	19	0,01/0,02/0,03/0,04/0,05/ 0,06/0,07/0,08/0,09/0,10/ 0,20/0,30/0,40/0,50/0,60/ 0,70/0,80/0,90/1,00	15 µm (0,20-0,30 mm) 20 µm (0,40-0,60 mm) 35 µm (0,70-1,00 mm)	21,80

Präzisions-Fühlerlehre rostfrei Precision feeler gauge stainless

Länge 75 mm | Breite 12,7 mm | rostfreier Stahl | Made in Japan | Etui
 Length 75 mm | Width 12.7 mm | Stainless steel | Made in Japan | sheath



Art.-Nr. Order no.	Anzahl Blätter number blades	Messbereich (mm) Range (mm)	Genauigkeit Accuracy	EUR
24-009	9	0,04/0,05/0,06/ 0,07/0,08/0,10/ 0,15/0,20/0,30	5 µm (0,04-0,10 mm) 15 µm (0,15-0,30 mm)	26,50

Lehren, Einstellringe Gauges, setting rings

Präzisions-Fühlerlehre **einzeln** Precision feeler gauge single leaf

Länge 100 mm | Breite 12,7 mm | Stahl oder rostfreier Stahl | Made in Japan
Length 100 mm | Width 12.7 mm | steel or stainless steel | Made in Japan

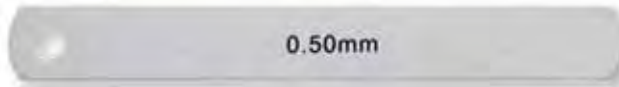

24-020-050

Nennmaß Thickness	Stahl Steel			rostfreier Stahl Stainless steel			
	Art.-Nr. Order no.	Genauigkeit Accuracy	EUR	Art.-Nr. Order no.	Genauigkeit Accuracy	EUR	
0,01 mm	24-020-001	5 µm	9,20				
0,02 mm	24-020-002		9,20				
0,03 mm	24-020-003		5,50				
0,04 mm	24-020-004		5,50		24-021-004	5 µm	9,85
0,05 mm	24-020-005		5,50		24-021-005		9,85
0,06 mm	24-020-006	5,50		24-021-006	9,85		
0,07 mm	24-020-007	10 µm	5,50	24-021-007	9,85		
0,08 mm	24-020-008		5,50		24-021-008		9,85
0,09 mm	24-020-009	5,50					
0,10 mm	24-020-010		3,60	24-021-010	5 µm	9,85	
0,11 mm	24-020-011	15 µm	3,60				
0,12 mm	24-020-012		3,60				
0,13 mm	24-020-013		3,60				
0,14 mm	24-020-014		3,60				
0,15 mm	24-020-015		3,60		24-021-015	15 µm	9,85
0,20 mm	24-020-020	3,60		24-021-020	9,85		
0,25 mm	24-020-025		3,60				
0,30 mm	24-020-030		3,60	24-021-030	15 µm	9,85	
0,35 mm	24-020-035		3,60				
0,40 mm	24-020-040	20 µm	3,60				
0,45 mm	24-020-045		3,60				
0,50 mm	24-020-050		3,60				
0,60 mm	24-020-060		5,50				
0,70 mm	24-020-070	35 µm	5,50				
0,80 mm	24-020-080		5,50				
0,90 mm	24-020-090		5,50				
1,00 mm	24-020-100		5,50				

Rissbreite-Lehre Crack width gauge

zum optischen Vermessen von Rissen, Spalten, Linienstärken u. ä. | Messbereich 0,1-2,0 mm | Maßstab 150 mm auf der Rückseite | rostfreier Stahl | Oberfläche mattiert | Made in Japan
for optical measuring of cracks, gaps, line widths etc. | Range 0.1-2.0 mm | ruler 150 mm on back side | stainless steel | surface matted | Made in Japan



Rückseite:
back side:



Art.-Nr. Order no.	EUR
24-015	4,90

Lehren, Einstellringe

Gauges, setting rings

Fühlerlehren-Band Feeler gauge band

12,7 mm x 5 m | Stahl | in Kunststoffdose
 12.7 mm x 5 m | steel | in plastic box



Art.-Nr. Order no.	Stärke thickness	EUR	Art.-Nr. Order no.	Stärke thickness	EUR
24-902	0,02 mm	16,50	24-912	0,12 mm	7,20
24-903	0,03 mm	8,90	24-914	0,14 mm	7,20
24-904	0,04 mm	8,90	24-915	0,15 mm	7,20
24-905	0,05 mm	7,20	24-918	0,18 mm	7,20
24-906	0,06 mm	7,20	24-920	0,20 mm	7,20
24-907	0,07 mm	7,20	24-925	0,25 mm	7,20
24-908	0,08 mm	7,20	24-930	0,30 mm	7,20
24-909	0,09 mm	7,20	24-950	0,50 mm	7,20
24-910	0,10 mm	7,20			

HELIOS-PREISSER Fühlerlehren-Band Feeler gauge band

gehärteter Kohlenstoffstahl | Breite 12,7 mm | Länge 5 m | ab 0,08 mm mit Maß beschriftet | in Kunststoffdose |
 Made in Germany
 hardened steel | width 12.7 mm | length 5 m | from 0.08 mm marked with dimension | in plastic box |
 Made in Germany



Art.-Nr. Order no.	Stärke thickness	EUR	Art.-Nr. Order no.	Stärke thickness	EUR
46-940	0,005 mm	77,50	46-956	0,30 mm	7,50
46-941	0,01 mm	43,80	46-957	0,35 mm	10,80
46-942	0,02 mm	33,50	46-958	0,40 mm	10,80
46-943	0,03 mm	12,50	46-959	0,45 mm	10,80
46-944	0,04 mm	12,50	46-960	0,50 mm	10,80
46-945	0,05 mm	10,80	46-961	0,55 mm	15,80
46-946	0,06 mm	8,90	46-962	0,60 mm	15,80
46-947	0,07 mm	8,90	46-963	0,65 mm	15,80
46-948	0,08 mm	8,90	46-964	0,70 mm	15,80
46-949	0,09 mm	8,90	46-965	0,75 mm	15,80
46-950	0,10 mm	8,90	46-966	0,80 mm	15,80
46-951	0,12 mm	8,90	46-967	0,85 mm	15,80
46-952	0,15 mm	8,90	46-968	0,90 mm	17,00
46-953	0,18 mm	8,90	46-969	0,95 mm	17,00
46-954	0,20 mm	8,90	46-970	1,00 mm	17,00
46-955	0,25 mm	8,90			

Halter für Fühlerlehrenband:
 holder for feeler gauge band:

Art.-Nr. Order no.	EUR
46-979	2,90



HELIOS-PREISSER Fühlerlehren-Set im Wandhalter Feeler gauge set with wall holder

15tlg., nachfüllbar mit Einzelkassetten | Wandhalter aus lackiertem Stahlblech | mit Halter für Fühlerlehrenband und Befestigungsmaterial | Made in Germany
 15 pieces, refillable with single boxes | wall holder from coated steel plate | incl. holder for feeler gauge band and mounting material | Made in Germany



Art.-Nr. Order no.	Stärke thickness	EUR
46-971	0,01-0,25 mm	219,00
46-972	0,30-1,00 mm	239,00

46-971

Lehren, Einstellringe Gauges, setting rings

Düsenlehre Jet gauge

mit Stahlstiften | Genauigkeit 5 µm | Etui
with steel pins | Accuracy 5 µm | sheath



Art.-Nr. Order no.	Anzahl pieces	Messbereich Range	EUR
24-301	16	1,5-3,0 mm	6,90
24-302	20	0,45-1,50 mm	7,80

HELIOS-PREISSER Bohrungsmessdorn Bore hole measuring pin gauge

Spezialstahl, Gehäuse vernickelt | Ablesung 0,1 mm | Kegel 1:10 | Made in Germany
special steel, housing nickel plated | reading 0.1 mm | cone 1:10 | Made in Germany



Art.-Nr. Order no.	Messbereich Range	EUR
46-917	0-3 mm	47,80
46-918	0-5 mm	58,00

HELIOS-PREISSER Bohrungslehre konisch Bore hole gauge conical

rostfreier gehärteter Stahl | Ablesung 0,1 mm | Griff gerändert | Made in Germany
stainless hardened steel | reading 0.1 mm | handle knurled | Made in Germany



Art.-Nr. Order no.	Messbereich Range	EUR
46-921	1-6 mm	54,00
46-922	4-15 mm	71,50
46-923	15-30 mm	149,00
46-924	30-45 mm	232,00
46-925	45-60 mm	369,00

HELIOS-PREISSER Lochlehre Hole gauge

Spezialstahl, nitriert | Stufung 0,1 mm | Made in Germany
special steel, nitrified | stepping 0.1 mm | Made in Germany

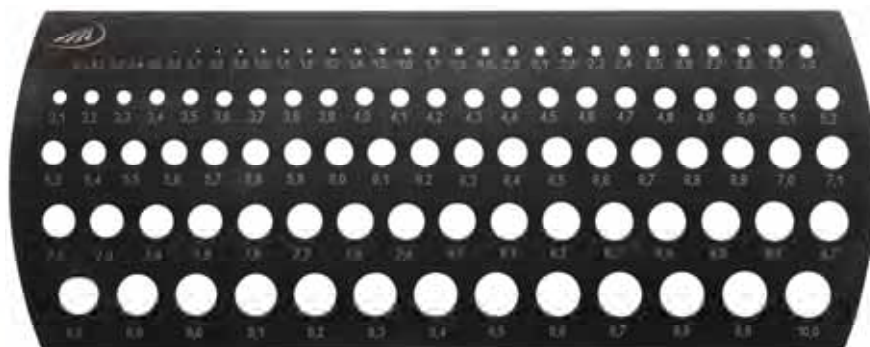

Art.-Nr. Order no.	Messbereich Range	EUR
46-927	0,1-10,0 mm	89,50
46-928	3,0-10,0 mm	67,50

46-927

Radiuslehre Radius gauge

Konvex- und Konkavlehren | Etui
convex and concave form | sheath

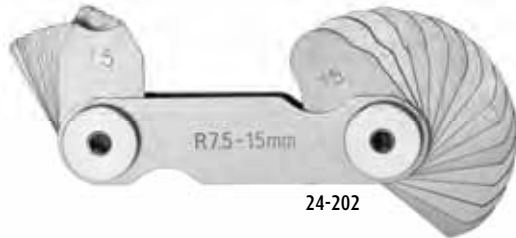

Art.-Nr. Order no.	Messbereich (Radius) Range (Radius)	Anzahl Blätter pieces/set	EUR
24-201	1-7 mm	2x 17	7,50
24-202	7,5-15 mm	2x 16	7,90
24-203	15,5-25 mm	2x 15	7,90

HELIOS-PREISSER Radiuslehre Radius gauge

Konvex- und Konkavlehren | rostfreier Stahl | Etui
convex and concave form | stainless steel | sheath



Art.-Nr. Order no.	Messbereich (Radius) Range (Radius)	Anzahl Blätter pieces/set	EUR
47-821	1-7 mm	2x 17	8,90
47-822	7,5-15 mm	2x 16	10,80
47-823	15,5-25 mm	2x 15	10,80

HELIOS-PREISSER Radiusmessgerät Radius measuring tool



zum Bestimmen der Radiengröße an Werkstücken (nur für Außenradius) |
Ablesung 0,1 mm | rostfreier Stahl | Ableseteile mattverchromt | Made in Germany
for determination of radiuses at workpieces (only outside radius) | reading 0.1
mm | stainless steel | satin chrome finished | Made in Germany



Art.-Nr. Order no.	EUR
46-901	169,00

Digital-Radiusmessgerät Digital Radius measuring tool

zum direkten Messen von Außen- und Innenradius | Messbereich 5-700 mm (Außenradius) / 6,5-700 mm (Innenradius) | Auflösung 0,001 mm | Genauigkeit 1% | inkl. 5 Messbrücken für unterschiedliche Messbereiche | Aufbewahrungsbox
for direct measurements of outside and inside radius | Range 5-700 mm (outside radius) / 6.5-700 mm (inside radius) | Reading 0.001 mm | Accuracy 1% | incl. 5 measuring bases for different ranges | box



Art.-Nr. Order no.	EUR
12-201	269,00

Anwendungsbeispiele Examples of use



Lehren, Einstellringe Gauges, setting rings

Fasenlehre Chamfer gauge

zum Messen von Fasen | Messbereich 0-15 mm | Ablesung 0,5 mm | rostfreier Stahl
for measuring of chamfers | Range 0-15 mm | Reading 0.5 mm | stainless steel

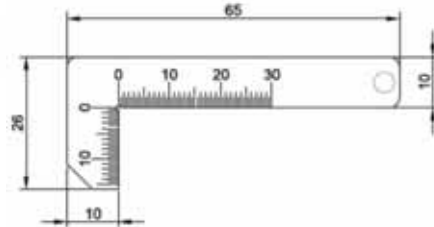

Art.-Nr. Order no.	EUR
24-211	5,80

Anwendungsbeispiele: *Examples of use:*

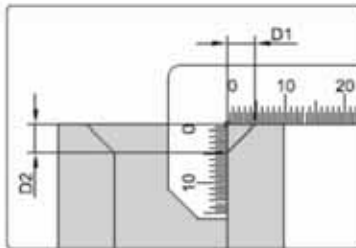
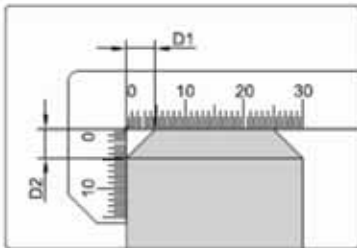

HELIOS-PREISSER Fasenmessgerät Chamfer measuring tool

zum gleichzeitigen Prüfen des Fasenwinkels und der Maßhaltigkeit | mit 3 auswechselbaren Schienen 30°/45°/60° |
Ablesung 0,1 mm | rostfreier Stahl | Ableseteile mattverchromt | Made in Germany
for determination of angle and dimension of chamfers | with 3 changeable bars 30°/45°/60° | reading 0.1 mm |
stainless steel | satin chrome finished | Made in Germany



Art.-Nr. Order no.	EUR
46-902	169,00

Winkellehre Angle gauge

zum Prüfen folgender Winkel: 1°, 2°, 3°, 4°, 5°, 6°, 7°, 8°, 9°, 10°, 12°, 14°, 16°, 18°, 20°, 25°, 30°, 35°, 40°, 45° | Etui
for checking following angles: 1°, 2°, 3°, 4°, 5°, 6°, 7°, 8°, 9°, 10°, 12°, 14°, 16°, 18°, 20°, 25°, 30°, 35°, 40°, 45° | sheath



Art.-Nr. Order no.	EUR
24-501	21,50

Schweißnahtlehre Welding seam gauge

zum Messen der Schweißnaht an rechtwinkligen Ecken | 12teilig | Messbereich 3,0-12 mm | Etui
for measuring right angled welds | 12 pieces | Range 3.0-12 mm | sheath



Art.-Nr. Order no.	EUR
24-401	11,00

Lehren, Einstellringe Gauges, setting rings

Präzisions-Schweißnahtlehre Precision welding seam gauge

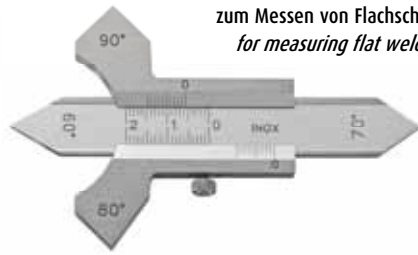

zum Messen von Flanschweißnähten und Eckschweißnähten mit Winkel 60°/70°/80°/90° | Ableseerteile mattverchromt | Etui
for measuring flat welding seams and welding seams in corners with angles 60°/70°/80°/90° | satin chrome finished | sheath

Art.-Nr. Order no.	EUR
24-411	16,50

Multifunktions-Schweißnahtlehre Multifunction welding seam gauge

vielfältige Messmöglichkeiten für Schweißnähte | rostfreier Stahl | mattierte Oberfläche | Made in Japan | Aufbewahrungsbox
manifold possibilities for measuring welding seams | stainless steel | matted surface | Made in Japan | box

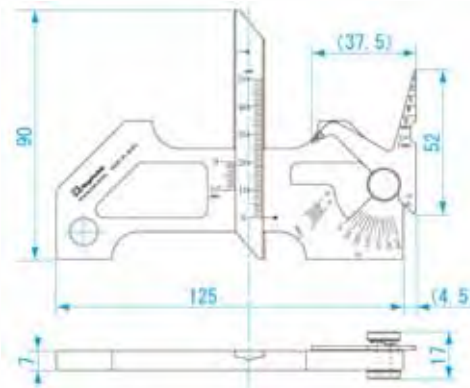

Art.-Nr. Order no.	EUR
24-413	159,00

Anwendungsbeispiele Examples of use

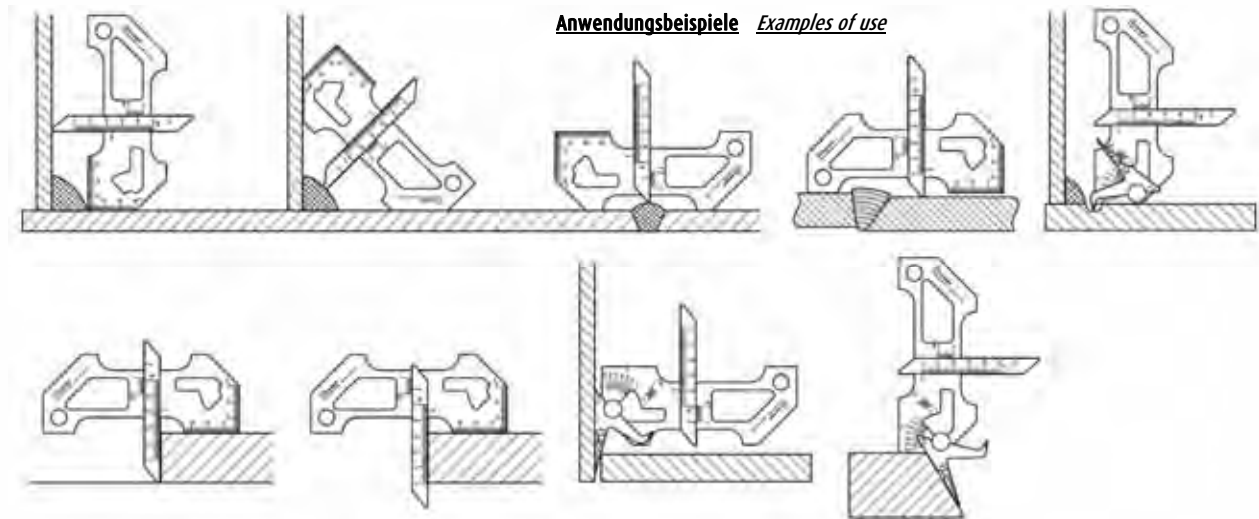

Spiralbohrer-Schleiflehre Twist drill grinding gauge



Messbereich 30°-160° | mit Zeigerfeststellung | Leichtmetall | Beschriftung lasergraviert | Gewindetabelle auf der Rückseite | Made in Germany
Range 30°-160° | with indicator locking | light metal | inscription by laser engraving | thread table on backside | Made in Germany

Art.-Nr. Order no.	EUR
24-431	9,80

01

02

03

04

05

06

07

08

09

10

11

12

13

14

15

Zentriergeräte, Kantentaster *Centre indicators, edge finders*



- 01
- 02
- 03
- 04
- 05
- 06
- 07
- 08
- 09**
- 10
- 11
- 12
- 13
- 14
- 15

Inhalt *Contents*



09.2



09.5



09.7



09.8

Zentriergeräte, Kantentaster Centre indicators, edge finders

Kantentaster *Edge finder*

rotierende Spindel, max. 600 U/min | Einspannschaft Ø10 mm | Antastgenauigkeit 0,01 mm | Etui
rotating spindle, max. 600 r.p.m. | Shank Ø10 mm | Accuracy 0.01 mm | box



32-001



32-002

Art.-Nr. Order no.	Länge Length	Antast Ø Probe Ø	EUR
32-001	84 mm	10 mm	16,50
32-002	94 mm	10/4 mm	19,00

TSCHORN Kantentaster ECO *Edge finder ECO*

mechanischer Kantentaster für max. 500 U/min | Einspannschaft Ø10 mm | Kunststoffbox
Mechanical edge finder for max. 500 r.p.m. | Shank Ø10 mm | box



32-501



32-502



Art.-Nr. Order no.	Antast Ø Probe Ø	EUR
32-501	10 mm	19,50
32-502	10/4 mm	19,50

Kantentaster **Keramik** *Edge finder ceramic*

rotierende Spindel, max. 600 U/min | verschleißfester Keramik-Tastkopf | Einspannschaft Ø10 mm | Antastgenauigkeit 0,01 mm | Etui
rotating spindle, max. 600 r.p.m. | wear-resistant ceramic head | Shank Ø10 mm | Accuracy 0.01 mm | box



Art.-Nr. Order no.	Länge Length	Antast Ø Probe Ø	EUR
32-009	84 mm	10 mm	41,50

Kantentaster **TiN** *Edge finder TiN*

rotierende Spindel, max. 600 U/min | Taster beschichtet mit verschleißfestem TiN (Titanitrid) | Einspannschaft Ø10 mm | Antastgenauigkeit 0,01 mm | Etui
rotating spindle, max. 600 r.p.m. | probe head covered with wear-resistant TiN layer (titanium nitride) | Shank Ø10 mm | Accuracy 0.01 mm | box



32-005



32-006

Art.-Nr. Order no.	Länge Length	Antast Ø Probe Ø	EUR
32-005	84 mm	10 mm	34,50
32-006	94 mm	10/4 mm	36,50

Zentriergeräte, Kantentaster Centre indicators, edge finders

TSCHORN Kantentaster **TiN** Edge finder **TiN**

mechanischer Kantentaster für max. 500 U/min | Tastkopf aus rostfreiem Edelstahl, beschichtet mit verschleißfestem TiN (Titanitrid) | anti-magnetisch | Einspannschaft Ø10 mm | Made in Germany | Kunststoffbox
Mechanical edge finder for max. 500 r.p.m. | probe head made out of stainless steel, covered with wear-resistant TiN layer (titanium nitride) | antimagnetical | Shank Ø10 mm | Made in Germany | box



32-531



32-532

Art.-Nr. Order no.	Antast Ø Probe Ø	EUR
32-531	10 mm	89,00
32-532	10/4 mm	99,00

Kantentaster mit **LED-Anzeige** Edge finder with **LED lamp**

mit federnder Tastkugel | zum Antasten von metallischen Werkstücken | Einspannschaft Ø20 mm | Antastgenauigkeit 0,01 mm | Etui
with spring-loaded front tip | for contacting of metallic work pieces | Shank Ø20 mm | Accuracy 0.01 mm | box



Art.-Nr. Order no.	Länge Length	Tastkugel front tip	EUR
32-021	105 mm	Ø10 mm	56,00

TSCHORN Kantentaster **optisch 2D** Edge finder **optical 2D**

zum genauen Ermitteln von Werkstücknullpunkten sowie Bohrungsmittelpunkten zur Arbeitsspindel | LED-Anzeige | Tastkugel Ø10 mm | Antastgenauigkeit 0,01 mm | Made in Germany | Kunststoffbox
for accurate zero point determination and bore centers to the spindle | LED signaling | probe ball Ø10 mm | accuracy of probing 0.01 mm | Made in Germany | box



32-552

Art.-Nr. Order no.	Schaft Ø Shank Ø	Länge Length	EUR
32-551	16 mm	99 mm	76,00
32-552	20 mm	94 mm	76,00



Achtung! Zum Schutz der eingebauten Elektronik ist der Kantentaster gegen das Eindringen von Feuchtigkeit zu schützen!
Caution! Protection against humidity is essential for the edge finder due to the built-in electronic components!

TSCHORN Kantentaster **optisch & akustisch 2D** Edge finder **optical & acoustic 2D**

zum genauen Ermitteln von Werkstücknullpunkten sowie Bohrungsmittelpunkten zur Arbeitsspindel | LED-Anzeige und akustisches Signal | Tastkugel Ø10 mm | Antastgenauigkeit 0,01 mm | Made in Germany | Kunststoffbox
for accurate zero point determination and bore centers to the spindle | LED and acoustic signaling | probe ball Ø10 mm | accuracy of probing 0.01 mm | Made in Germany | box



Art.-Nr. Order no.	Schaft Ø Shank Ø	Länge Length	EUR
32-561	20 mm	119 mm	155,00



Achtung! Zum Schutz der eingebauten Elektronik ist der Kantentaster gegen das Eindringen von Feuchtigkeit zu schützen!
Caution! Protection against humidity is essential for the edge finder due to the built-in electronic components!

Zentriergeräte, Kantentaster Centre indicators, edge finders

TSCHORN Präzisionsmesstaster 3D Precision probe 3D

zum hochgenauen dreidimensionalen Antasten auf Bearbeitungsmaschinen (X/Y/Z) | LED-Anzeige |
Tastkugel Ø10 mm | Antastgenauigkeit 0,005 mm (alle drei Achsen) | mit Seriennummer und Werkzertifikat |
Made in Germany | Kunststoffbox
*for highly precise three dimensional probing on metal-cutting machines (X/Y/Z) | LED signaling |
probe ball Ø10 mm | accuracy of probing 0.005 mm (all three axis) | with serial number and test certificate |
Made in Germany | box*



Art.-Nr. Order no.	Schaft Ø Shank Ø	Länge Length	EUR
32-571	20 h4	167 mm	218,00



Achtung! Zum Schutz der eingebauten Elektronik ist der Kantentaster gegen das Eindringen von Feuchtigkeit zu schützen!
Caution! Protection against humidity is essential for the edge finder due to the built-in electronic components!

TSCHORN Lasertaster mit Fadenkreuz Laser probe with crosslines

zum schnellen, einfachen, kontaktlosen, groben Positionieren
von Werkstücken | Drehschalter zum manuellen Ein- und
Ausschalten | Fokus 100 mm | Made in Germany
*for fast, simple, contactless, rough positioning of
workpieces | rotary switch for manual switching on/off |
focus 100 mm | Made in Germany*



Art.-Nr. Order no.	Schaft Ø Shank Ø	EUR
32-581	16 mm	185,00

Anwendungsbeispiele: *Examples of use:*

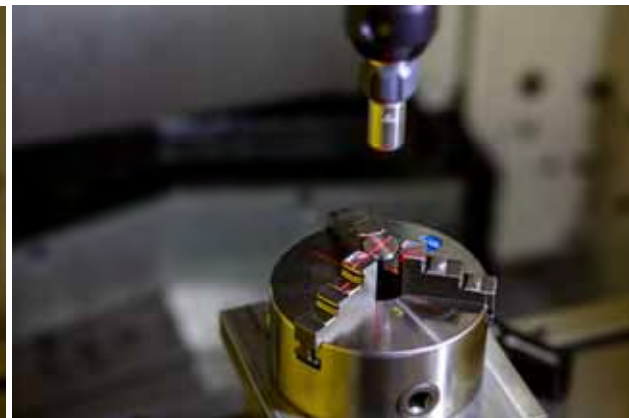
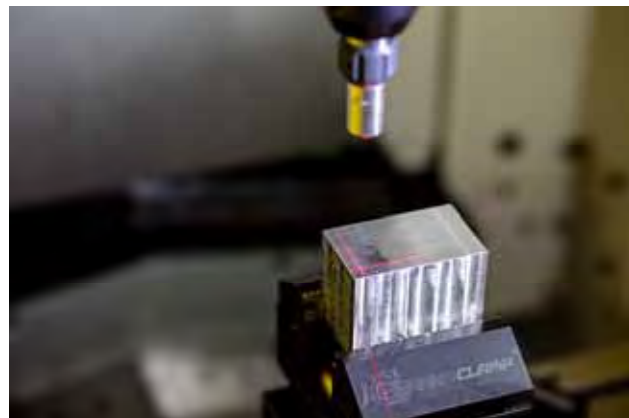

Fräser-Anreißnadel Milling scriber

Anreißen mit der Fräsmaschine | federnd gelagerte Anreißnadel mit Hartmetall-
Spitze | Federweg 10 mm | Gesamtlänge 146 mm | Konzentrität 0,02 mm |
Vorschubgeschwindigkeit 150 mm/min (keine Rotation notwendig)
*Scribing by milling operation | spring-loaded scriber with carbide tip | range of
spring 10 mm | Overall length 146 mm | Concentricity 0.02 mm | suitable feed
speed 150 mm/min (not necessary to rotate)*

Art.-Nr. Order no.	Einspannschaft Shank	EUR
32-051	Ø20 x 60 mm	188,00



Ersatz-Anreißnadel: Spare part scriber:	Art.-Nr. Order no.	EUR
	32-053	48,50

Anwendungsbeispiel *Example of use*

Zentriergeräte, Kantentaster Centre indicators, edge finders

Einstellgerät Z-Achse Z-zero setter

zum einfachen Bestimmen des Referenzpunktes bei CNC- und konventionellen Maschinen | Abmessung Ø55x50 mm | Referenzhöhe 50 mm | Messuhr Ø40 mm | Ablesung 0,01 mm | Tastfläche Ø32 mm, gehärtet
for simply determining Z-axis zero-position of CNC and conventional machines | dimensions Ø55x50 mm | Reference 50 mm | Dial gauge Ø40 mm | Reading 0.01 mm | Surface Ø32 mm, hardened



Art.-Nr. Order no.	EUR
32-211	79,00

Einstellgerät Z-Achse mit Magnet Z-zero setter with magnet

zum einfachen Bestimmen des Referenzpunktes bei CNC- und konventionellen Maschinen | mit Dauermagnet am Fuß | Abmessung 61x54x52 mm | Referenzhöhe 50 mm | Messuhr Ø40 mm | Ablesung 0,01 mm | Tastfläche Ø26,6 mm, gehärtet
for simply determining Z-axis zero-position of CNC and conventional machines | with magnet on bottom | dimensions 61x54x52 mm | Reference 50 mm | Dial gauge Ø40 mm | Reading 0.01 mm | Surface Ø26.6mm, hardened



Art.-Nr. Order no.	EUR
32-212	98,00

Digital-Einstellgerät Z-Achse mit Magnet Digital Z-zero setter with magnet

zum einfachen Bestimmen des Referenzpunktes bei CNC- und konventionellen Maschinen | mit Dauermagnet am Fuß | Abmessung Ø55x53 mm | Referenzhöhe 50 mm | Auflösung 0,001 mm | Tastfläche Ø24,7 mm, gehärtet
for simply determining Z-axis zero-position of CNC and conventional machines | with magnet on bottom | dimensions Ø55x53 mm | Reference 50 mm | Reading 0.001 mm | Surface Ø24.7 mm, hardened



Art.-Nr. Order no.	EUR
32-214	89,00

Zentriergeräte, Kantentaster Centre indicators, edge finders

TSCHORN Nulleinstellgerät Zero setter

zum einfachen Bestimmen des Referenzpunktes bei CNC- und konventionellen Maschinen | Gehäuse Ø39 mm | Referenzhöhe 50 mm | Taster Ø20 mm | Ablesung 0,01 mm | Sicherheitsfederweg 2 mm | für seitliche Anbringung optional auch mit Magnet lieferbar | Made in Germany | Kunststoffbox

for simply determining Z-axis zero-position of CNC and conventional machines | housing Ø39 mm | Reference 50 mm | Surface Ø20 mm | Reading 0.01 mm | Safety spring range 2 mm | for lateral mounting optional with built-in magnet | Made in Germany | box



32-601

Art.-Nr. Order no.	Magnet magnet	EUR
32-601	ohne without	129,00
32-602	mit with	165,00

TSCHORN Nulleinstellgerät „Micro“ Zero setter „Micro“

zum einfachen Bestimmen des Referenzpunktes bei CNC- und konventionellen Maschinen, auch für Micro-Werkzeuge (z. B. Fräser Ø0,1 mm) geeignet | Gehäuse Ø54,5 mm | Referenzhöhe 100 mm | Taster Ø42 mm | Ablesung 0,01 mm | Sicherheitsfederweg 2 mm | für seitliche Anbringung optional auch mit Magnet lieferbar | mit Seriennummer und Werkszertifikat | Made in Germany | Holzbox

for simply determining Z-axis zero-position of CNC and conventional machines, suitable also for micro-tools (e. g. milling tools Ø0.1 mm) | housing Ø54.5 mm | Reference 100 mm | Surface Ø42 mm | Reading 0.01 mm | Safety spring range 2 mm | for lateral mounting optional with built-in magnet | with serial number and test certificate | Made in Germany | wooden box



32-621

Art.-Nr. Order no.	Magnet magnet	EUR
32-621	ohne without	243,00
32-622	mit with	298,00

TSCHORN Nulleinstellgerät optisch Zero setter optical

zum einfachen Bestimmen des Referenzpunktes bei CNC- und konventionellen Maschinen | Gehäuse Ø39 mm | Referenzhöhe 50 mm | Taster Ø19 mm | LED-Anzeige | Sicherheitsfederweg 2 mm | für seitliche Anbringung optional auch mit Magnet lieferbar | mit Seriennummer und Werkszertifikat | Made in Germany | Holzbox

for simply determining Z-axis zero-position of CNC and conventional machines | housing Ø39 mm | Reference 50 mm | Surface Ø19 mm | LED signaling | Safety spring range 2 mm | for lateral mounting optional with built-in magnet | with serial number and test certificate | Made in Germany | wooden box



32-641

Art.-Nr. Order no.	Magnet magnet	EUR
32-641	ohne without	169,00
32-642	mit with	195,00

Zentriergeräte, Kantentaster Centre indicators, edge finders

Spannbügel für Messuhr *Clamping bracket for dial gauge*

Aufnahmeschaft $\text{\O}8 \times 23$ mm | Bügellänge 58 mm | Messuhr-Aufnahme $\text{\O}4$ - $\text{\O}8$ mm
Shank $\text{\O}8 \times 23$ mm | bracket length 58 mm | Seat for dial gauge $\text{\O}4$ - $\text{\O}8$ mm



Anwendungsbeispiel:
Example for use:



Art.-Nr. Order no.	EUR
30-046	9,80

Zentriergerät mit Feintaster *Centre indicator with precision dial gauge*

Aufnahmeschaft $\text{\O}8 \times 40$ mm | zentrale Kraftklemmung | Länge 160 mm | für Außen- und Innendurchmesser bis 300 mm | Ablesung 0,01 mm
Shank $\text{\O}8 \times 40$ mm | central mechanical clamping | Length 160 mm | for outside and inside diameter up to 300 mm | Reading 0.01 mm



Art.-Nr. Order no.	EUR
30-041	81,50

Zentriergerät *Centre indicator*

zur Bestimmung des Mittelpunkts von Bohrungen und Wellen | nicht-rotierende Uhr (ca. $\text{\O}40$ mm) | Einspannschaft $\text{\O}10$ mm | max. Drehzahl 150 U/min | Ablesung 0,01 mm | Genauigkeit 0,02 mm | Messbereich 3,5-300 mm (innen), 0-300 mm (außen) | mit Außen- und Innentaster (Länge bis 150 mm)
to find the centre point of holes and shafts | non-rotating dial gauge (approx. $\text{\O}40$ mm) | Shank $\text{\O}10$ mm | max. 150 r.p.m. | Reading 0.01 mm | Accuracy 0.02 mm | Range 3.5-300 mm (inside), 0-300 mm (outside) | with outside and inside sensors (length up to 150 mm)



Art.-Nr. Order no.	EUR
32-101	135,00

Zentriergeräte, Kantentaster Centre indicators, edge finders

TSCHORN Zentriergerät „CENTREplus“ Coaxial indicator „CENTREplus“

zum einfachen Zentrieren von Bohrungen oder Wellen | Antastgenauigkeit 0,01 mm | Messbereich Ø 0-110 mm | Schaft Ø12 mm | inkl. Messuhr | inkl. Hersteller-Zertifikat für Messuhr | Made in Germany
for simple centering of boreholes and spindles | probing accuracy 0.01 mm | Range Ø 0-110 mm | Shaft 12 mm | dial gauge included | manufacturers certificate for dial gauge included | Made in Germany

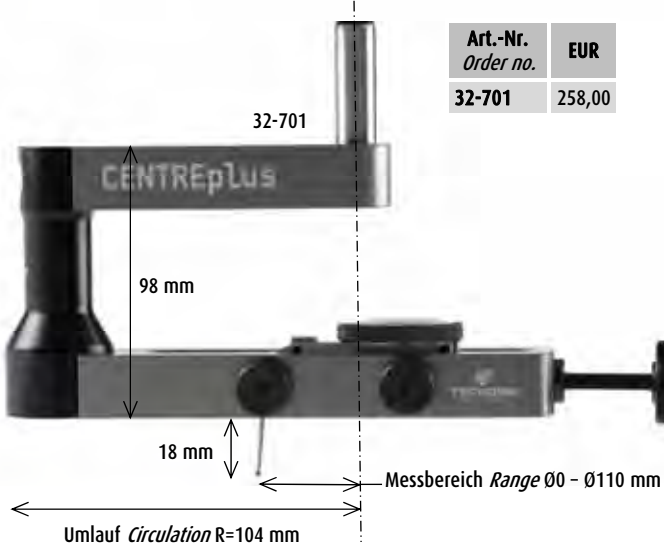

Art.-Nr. Order no.	EUR
32-701	258,00

Anwendungsbeispiel: *Example of use:*



32-705

Zubehör:
Accessories:

Art.-Nr. Order no.	Zubehör-Artikel Accessory article	EUR
32-705	Kurzarm (Messbereich bis Ø200 mm) Short-arm (measuring range up to Ø200 mm)	63,50

HAIMER Universal-3D-Taster Universal 3D-sensor

zum schnellen Setzen von Werkstück-Nullpunkten und zum Vermessen | beliebige Antastrichtung (X-/Y-/Z-Achse) | stoßgeschützt | Messuhr-Ausschlag immer in die gleiche Richtung | Einspannschaft Ø20 mm | Länge ohne Einspannschaft 113 mm | inkl. Tasteinsatz Ø4mm | Made in Germany
for setting zero and for measuring | any sensor direction (X-/Y-/Z-axis) | shock proof | deflection of dial gauge always in same direction | shank Ø20 mm | Length w/o shank 113 mm | incl. sensor insert Ø4 mm | Made in Germany



Art.-Nr. Order no.	Typ type	Auflösung Reading	EUR
32-131	analog IP67	0,01 mm	293,00
32-133	digital	0,001 mm	498,00

Ersatztaster:
spare part sensor insert:

Art.-Nr. Order no.	Tastkugel sensor insert	EUR
32-135	Ø4 mm	22,80
32-136	Ø8 mm	34,50

Zentriergeräte, Kantentaster Centre indicators, edge finders

TSCHORN 3D-Taster „SAVEplus“ 3D-sensor „SAVEplus“

zum universellen Vermessen in allen Richtungen (X/Y/Z) direkt in der Bearbeitungsmaschine | Ablesung 0,01 mm | Einspannschaft Ø12 h6 | Länge ohne Einspannschaft 134 mm | Skala justierbar | antimagnetisch | inkl. Tasteinsatz Keramik mit Hartmetallkugel Ø3 mm | Made in Germany

for universal measuring of all directions (X/Y/Z) directly within the metal-cutting machine | Reading 0.01 mm | Shaft Ø12 h6 | Length w/o shaft 134 mm | Scale adjustable | non-magnetic | incl. solid carbide probe tip Ø3 mm | Made in Germany



32-801

Ersatztaster:
spare part sensor insert:

Art.-Nr. Order no.	EUR
32-801	195,00



32-803* Stahl + HM-Kugel
Steel + carbide ball

32-804 Keramik + HM-Kugel
ceramic + carbide ball

32-806 Stahl + HM-Kugel Ø6 mm
steel + carbide ball Ø6 mm

Art.-Nr. Order no.	Tastkugel sensor insert	Länge Length	EUR
32-803*	Ø3 mm	27 mm	24,80
32-804	Ø3 mm	27 mm	28,90
32-806	Ø6 mm	62 mm	42,50

*Auslaufartikel discontinued model

TSCHORN 3D-Taster „DREHplus“ 3D-sensor „DREHplus“

zum Vermessen Ihrer Werkzeuge in allen Achsen (X/Y/Z) **speziell für Drehmaschinen** | patentierter konischer Tastkörper zum direkten Tasten auf Spindelmitte (X=0 und Y=0) ohne weitere Berechnungen | Ablesung 0,01 mm | Einspannschaft Ø20 mm | Länge ohne Einspannschaft 138 mm | inkl. Werkszertifikat | Made in Germany

for measuring of your turning tools in all directions (X/Y/Z) specially on turning machines | patented conical probing corpus for directly probing the centre of the spindle (X=0 and Y=0) without further calculations | Reading 0.01 mm | Shaft Ø20 mm | Length w/o shaft 138 mm | incl. factory certificate | Made in Germany

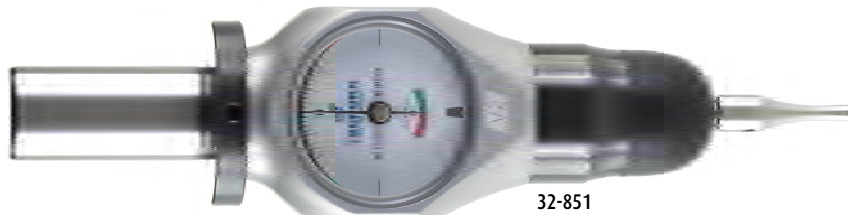

32-851

Art.-Nr. Order no.	EUR
32-851	437,00

Ersatztaster:
spare part sensor insert:

Art.-Nr. Order no.	Taster sensor insert	Länge Length	EUR
32-853	DREHplus	34 mm	114,00



32-853

Innovative Antasttechnologie

Der konische Tastkörper ermöglicht es Ihnen jedmögliche Schneidplatte mit diversen Radien und/oder Winkeln an einer beliebigen Stelle des Tastkörpers zu vermessen. Sie tasten bis beide Zeiger „0“ anzeigen. In dieser Stellung liegt die Außenlinie des konischen Tastkörpers exakt auf der Symmetrieachse.

Kein anderes Messmittel ermöglicht es Ihnen die Drehmitte derart schnell, einfach und präzise einzumessen.

Y=0 entspricht der Drehmitte. Dadurch sichern Sie bestmögliche Bearbeitung, erreichen hohe Standzeiten und erhalten beste Oberflächen.

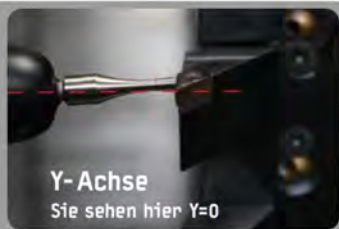

Y-Achse
Sie sehen hier Y=0



X-Achse
Sie sehen hier X=0

Ohne weitere Berechnungen messen Sie Ihre Werkzeuge auf die Spindelmitte bzw. X=0 aus.

Innovative probing technology

The conical probing corpus allows you to measure any possible cutting insert with various radii and/or angles at any point of the probing corpus. You probe until both indicators show „0“. In this position, the outline of the conical probing corpus is exactly on the symmetry axis.

Y axis

No other measuring equipment gives you the possibility to measure the rotating centre so simply, precisely and directly in your lathe.

Y=0 corresponds to the rotating centre.

X axis

Without any further calculation, you measure your tools to the centre of the spindle, respectively X=0.

Messtische, Stative, Schraub- stöcke, Parallelunterlagen

Granite plates, dial stands, bench vices, parallel supports



Inhalt Contents



10.2



10.3



10.5



10.7



10.11



10.16

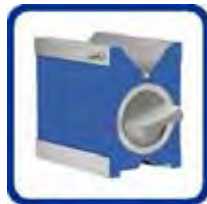

10.18



10.20



10.22

Normen Standards

Alle unsere Hartgestein-Prüfplatten nach DIN 876 erfüllen folgende Werte:
All our hard stone plates according to DIN 876 comply with following values:

Länge der Platte (mm) <i>length of plate (mm)</i>	160	250	400	630	1000	1600
Ebenheitstoleranz bei Genauigkeitsgrad 00 (μm) <i>Evenness tolerance at accuracy level 00 (μm)</i>	3	3	3	4	4	6
Ebenheitstoleranz bei Genauigkeitsgrad 0 (μm) <i>Evenness tolerance at accuracy level 0 (μm)</i>	5	5	6	7	8	11
Ebenheitstoleranz bei Genauigkeitsgrad 1 (μm) <i>Evenness tolerance at accuracy level 1 (μm)</i>	12	13	14	17	20	26

Weitere Informationen: siehe DIN 876 (DIN Deutsches Institut für Normung e. V., erschienen im Beuth Verlag)
Further information: see DIN 876 (DIN Deutsches Institut für Normung e. V., published by Beuth Verlag)

Kalibrierung Calibration

Informationen zur Kalibrierung erhalten Sie in Kapitel 15!
Information about calibration can be found in chapter 15!

Messtische, Stative, Schraubstöcke, Parallelunterlagen Granite plates, dial stands, bench vices, parallel supports

Universal-Halter *Universal holder*

für runde Messmittel wie Lehdorne, Messstifte, etc. | Gewicht 2 kg | Aufnahme max. Ø20 mm | Backenbreite 32 mm | Neigung einstellbar
for round measuring tools such as plug gauges, pin gauges, etc. | weight 2 kg | seat max. Ø20 mm | jaw width 32 mm | inclination adjustable



Anwendungsbeispiel mit Lehdorn (waagrecht)
example of use with plug gauge (horizontal)



Anwendungsbeispiel mit Prüfstift (senkrecht)
example of use with pin gauge (vertical)

Art.-Nr. Order no.	EUR
11-192	26,50

FISSO Leiterplattenhalter *Printed circuit board holder*



universeller Halter für Leiterplatten o. ä. zum Montieren, Löten, Prüfen, etc. |
Klemmzwinge mit Kunststoffbacken 50 mm | Gesamthöhe 433 mm | Aktionsradius
280 mm | Stahlsockel Ø150 mm | Swiss made

*Universal holder for printed circuit boards for mounting,
soldering, testing, etc. | Quick clamp with plastic jaws 50 mm |
Overall height 433 mm | Radius of movement 280 mm | steel
base Ø150 mm | Swiss made*



Art.-Nr. Order no.	EUR
41-301	269,00

FISSO Fixierhalter *Fixation holder*



universeller Halter („dritte Hand“): Stabiler Halt für fast alles, fast überall |
Swiss made

*Universal holder ("third hand"): Strong lock for almost everything,
almost everywhere | Swiss made*



Art.-Nr. Order no.	Aktionsradius Radius of movement	Klemmzwingen unten/oben clamping tongs bottom/top	EUR
41-311	400 mm	75/50 mm	339,00
41-312	620 mm	110/75 mm	545,00

Anwendungsbeispiel *Example of use*

Messtische, Stative, Schraubstöcke, Parallelunterlagen Granite plates, dial stands, bench vices, parallel supports

Kleinmesstisch rund *Small measuring table round*



Tisch Ø50 mm | Aufnahmebohrung Ø8 mm | Säule Ø28 mm | Querarm 75 mm | Gussfuß mit Tisch aus Spezialstahl
Table Ø20 mm | seat hole Ø8 mm | pillar Ø28 mm | transverse arm 75 mm | base from cast iron with steel table

Art.-Nr. Order no.	Messhöhe measuring height	EUR
31-001	100 mm	138,00

BENZING Kleinmesstisch rund *Small measuring table round*



Tisch Ø50 mm | Aufnahmebohrung Ø8 mm | Säule Ø22mm | Ausladung 49 mm | Messhöhe 100 mm |
Lieferung ohne Messuhr
Table Ø20 mm | seat hole Ø8 mm | pillar Ø22 mm | throat 49 mm | measuring height 100 mm |
without dial gauge



Art.-Nr. Order no.	Messtisch measuring table	Ebenheit evenness	Typ type	EUR
49-110			Standard	149,00
49-111	Stahl steel	4,4 µm	mit Feineinstellung <i>with fine adjustment</i>	298,00
49-112			Rundlauf* <i>concentricity*</i>	229,00
49-113	Keramik ceramic	2,0 µm	Standard	322,00
49-114			mit Feineinstellung <i>with fine adjustment</i>	476,00



49-111



49-112*



49-113

*mit Horizontalmessbügel für Rundlaufprüfung und zum Messen von Rillen und Einstichen
*with horizontal bracket for runout inspection and for measuring of grooves and cut-ins

Kleinmesstisch rechteckig *Small measuring table square*

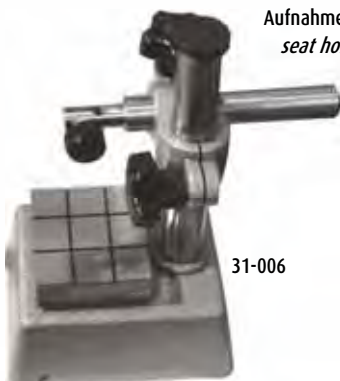

Aufnahmebohrung Ø8 mm | Gussfuß mit Tisch aus Spezialstahl
seat hole Ø8 mm | base from cast iron with steel table

Art.-Nr. Order no.	Messtisch measuring table	Querarm transverse arm	Messhöhe measuring height	EUR
31-006	60x68 mm	Ø18x140 mm	100 mm	168,00
31-007	115x98 mm	Ø18x190 mm	150 mm	185,00

31-006

Messtische, Stative, Schraubstöcke, Parallelunterlagen Granite plates, dial stands, bench vices, parallel supports

BENZING Kleinmesstisch rechteckig *Small measuring table square*

Tisch 60x68 mm (Keramik: 60x75 mm) | Aufnahmebohrung Ø8 mm | Säule Ø22mm | Ausladung 49 mm | Länge Querarm 120 mm (nur 49-121/49-123) | Messhöhe 100 mm | Lieferung ohne Messuhr
Table 60x68 mm (ceramic: 60x75 mm) | seat hole Ø8 mm | pillar Ø22 mm | throat 49 mm | length of transverse arm 120 mm (only 49-121/49-123) | measuring height 100 mm | without dial gauge



49-120



49-123

Art.-Nr. Order no.	Messtisch measuring table	Ebenheit evenness	Querarm transverse arm	EUR
49-120	Stahl steel	4,3 µm	starr <i>rigid</i>	189,00
49-121	Stahl steel		verschiebbar <i>adjustable</i>	216,00
49-122	Keramik ceramic	2,0 µm	starr <i>rigid</i>	438,00
49-123	Keramik ceramic		verschiebbar <i>adjustable</i>	462,00

BENZING Stahl-Messtisch *Steel measuring table*

Tisch 170x215 mm | Aufnahmebohrung Ø8 mm | Säule Ø35mm | Ausladung 104 mm | Ebenheit 0,005 mm | Tischfläche geläppt | Staubnuten | Lieferung ohne Messuhr
Table 170x215 mm | seat hole Ø8 mm | pillar Ø35 mm | throat 104 mm | evenness 0.005 mm | table lapped | dust notches | without dial gauge



49-130

Art.-Nr. Order no.	Säule pillar	Querarm transverse arm	Messhöhe measuring height	EUR
49-130	glatt <i>flat</i>	starr <i>rigid</i>	165 mm	685,00
49-131		verschiebbar <i>adjustable</i>	175 mm	740,00
49-132	Gewinde mit Stellingring <i>thread with locating ring</i>	starr <i>rigid</i>	165 mm	698,00
49-133	Handrad-Höhenverstellung <i>handwheel height adjustment</i>		155 mm	985,00



49-131



49-132



49-133

Kleinmesstisch Hartgestein *Small measuring table hard stone*

aus Hartgestein | Aufnahmebohrung Ø8 mm | Ausladung 100 mm
hard stone base | seat hole Ø8 mm | throat 100 mm



Art.-Nr. Order no.	Messtisch measuring table	Säule pillar	EUR
31-053	150x100 mm	Ø30x150 mm	79,00

Messtische, Stative, Schraubstöcke, Parallelunterlagen

Granite plates, dial stands, bench vices, parallel supports

Feinmesstisch *Measuring table*

aus Hartgestein | DIN 876 Genauigkeitsgrad 0 | Messuhr-Aufnahmebohrung Ø8 mm | Säule Ø30 mm
hard stone base | DIN 876 accuracy level 0 | seat hole for dial gauge Ø8 mm | pillar Ø30 mm

mit starrem Querarm (Ausladung 85 mm)
with rigid transverse arm (throat 85 mm)

Art.-Nr. Order no.	Messtisch measuring table	Säulenhöhe Height of pillar	EUR
31-100	200x150x50 mm	200 mm	119,00
31-102	300x250x65 mm	300 mm	148,00
31-103	400x300x65 mm		191,00



mit verschiebbarem Querarm (Ø20x210 mm)
with adjustable transverse arm (Ø20x210 mm)

Art.-Nr. Order no.	Messtisch measuring table	Säulenhöhe Height of pillar	EUR
31-120	200x150x50 mm	200 mm	127,00
31-122	300x250x65 mm	300 mm	156,00
31-123	400x300x65 mm		199,00



Feinmesstisch mit Steilgewinde-Höhenverstellung *Measuring table with height adjustment by helical thread*

aus Hartgestein | DIN 876 Genauigkeitsgrad 0 | Messuhr-Aufnahmebohrung Ø8 mm | Säule Ø30 mm | mit Stellring
hard stone base | DIN 876 accuracy level 0 | seat hole for dial gauge Ø8 mm | pillar Ø30 mm | with adjusting ring

mit starrem Querarm (Ausladung 85 mm)
with rigid transverse arm (throat 85 mm)

Art.-Nr. Order no.	Messtisch measuring table	Säulenhöhe Height of pillar	EUR
31-130	200x150x50 mm	200 mm	158,00
31-132	300x200x65 mm	300 mm	188,00



mit verschiebbarem Querarm (Ø20x210 mm)
with adjustable transverse arm (Ø20x210 mm)

Art.-Nr. Order no.	Messtisch measuring table	Säulenhöhe Height of pillar	EUR
31-140	200x150x50 mm	200 mm	166,00
31-142	300x200x65 mm	300 mm	196,00



01

02

03

04

05

06

07

08

09

10

11

12

13

14

15

Messtische, Stative, Schraubstöcke, Parallelunterlagen

Granite plates, dial stands, bench vices, parallel supports

Feinmesstisch-System *Measuring table system*

Anwendungsbeispiele:

Examples of use:



Grundplatten *base plates*

aus Hartgestein | nach DIN 876 Genauigkeit 0 | ohne Messstative

from hard stone | according to DIN 876 accuracy level 0 | without stand

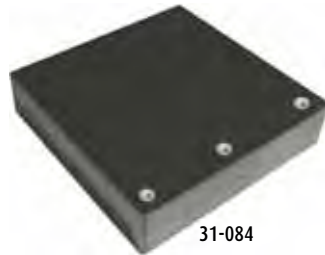

Art.-Nr. Order no.	Messtisch measuring table	Gewinde threads	Gewicht weight	EUR
31-081	150x150x40 mm	1x M8	3 kg	46,50
31-082	300x200x50 mm	2x M8	9 kg	91,00
31-083	400x250x50 mm	3x M8	16 kg	125,00
31-084	400x400x50 mm		22 kg	176,00

Einbau-Messstativ *integration stand*

Aufnahmebohrung Ø4/Ø8 mm | mit Feineinstellung

Seat hole Ø4/Ø8 mm | with fine adjustment



Art.-Nr. Order no.	Befestigungsgewinde mounting thread	Säule pillar	Querarm transverse arm	EUR
31-091	M8	Ø12x167 mm	Ø10x150 mm	8,50
31-092	M10	Ø16x226 mm	Ø12x220 mm	14,80

Gewindeadapter *thread adaptor* M8/M10:



Art.-Nr. Order no.	EUR
31-089	11,50

Einbau-Messstativ mit Zentralklemmung:

Integration stand with central clamping:

Befestigungsgewinde M8 |

Aufnahmebohrung Ø8 mm | Schwalbenschwanz

Mounting thread M8 | seat hole Ø8 mm / dovetail



Art.-Nr. Order no.	Gesamtlänge total length	EUR
31-094	280 mm	28,50

Einbau-Messstativ mit dicker Säule:

Integration stand with thick pillar:

Befestigungsgewinde M8 | Säule Ø30x200 mm |

Aufnahmebohrung Ø8 mm

Mounting thread M8 | pillar Ø30x200 mm | seat hole Ø8 mm



Art.-Nr. Order no.	Querarm transverse arm	EUR
31-150	starr (Ausladung 85 mm) <i>rigid (throat 85 mm)</i>	89,00
31-170	verschiebbar (Ø20x210 mm) <i>adjustable transverse arm</i>	97,00

Einbau-Messstativ mit Steilgewinde-Höhenverstellung:

Integration stand with height adjustment by helical thread:

Befestigungsgewinde M8 | verschiebbarer Querarm |

Aufnahmebohrung Ø8 mm | Made in Germany

Mounting thread M8 | with adjustable transverse arm | seat hole Ø8 mm | Made in Germany



Art.-Nr. Order no.	Säule pillar	Querarm transverse arm	EUR
31-099	Ø35x245 mm	Ø22x180 mm	417,00

Messtische, Stative, Schraubstöcke, Parallelunterlagen Granite plates, dial stands, bench vices, parallel supports

Präzisions-Messtisch mit Höhenverstellung mit Skalierung *Precision measuring table with height adjustment with scale*

Einfache und präzise Höheneinstellung durch Handrad und Skalierung | Grundplatte aus Hartgestein | DIN 876 Genauigkeitsgrad 0 | Messbereich (Höhe) 160 mm | Messuhr-Aufnahmebohrung Ø8 mm | verstellbarer Querarm

Simple and precise height adjustment by hand wheel and scale | hard stone base | DIN 876 accuracy level 0 | Range (height) 160 mm | seat hole for dial gauge Ø8 mm | adjustable transverse arm



Art.-Nr. Order no.	Messtisch measuring table	EUR
31-190	250x160x50 mm	695,00

Hartgestein-Messplatte *Hard stone plate*

nach DIN 876 Genauigkeit 0
according to DIN 876 accuracy level 0



31-207

Art.-Nr. Order no.	Abmessungen dimensions	Gewicht weight	EUR
31-200	300x300x50 mm	13 kg	89,50
31-201	400x250x50 mm	16 kg	108,00
31-202	400x400x100 mm	45 kg	163,00
31-203	630x400x100 mm	76 kg	299,00
31-204	630x630x100 mm	130 kg	372,00
31-205	800x500x100 mm	120 kg	488,00
31-206	1000x630x100 mm	180 kg	695,00
31-207	1200x800x150 mm	450 kg	1275,00

stabiles Stahl-Gestell mit Justierschrauben, Höhe ca. 700 mm:

Support stand from steel with adjustable screws, height approx. 700 mm:



31-222

Art.-Nr. Order no.	für Messplatte for hard stone plate	Abmessung dimensions	EUR
31-221	630x400x100 mm	ca. 430x280 mm	239,00
31-222	630x630x100 mm	ca. 430x430 mm	268,00
31-223	800x500x100 mm	ca. 530x340 mm	285,00
31-224	1000x630x100 mm	ca. 670x440 mm	298,00
31-225	1200x800x150 mm	ca. 740x510 mm	377,00

Messtische, Stative, Schraubstöcke, Parallelunterlagen Granite plates, dial stands, bench vices, parallel supports

OELZE Hartgestein-Messplatte *Hard stone plate*

Oberfläche geläpft | Seitenflächen geschliffen | Kanten umseitig gefast | Auflagepunkte an der Unterseite zur statisch bestimmten Lagerung | Lieferung inkl. Hersteller-Prüfprotokoll | Made in Germany
top surface lapped | side surface ground | borders with chamfer | bottom side with supporting points for static determined mounting | delivery with manufacturers inspection certificate | Made in Germany



48-049

Abmessungen <i>dimensions</i>	Gewicht <i>weight</i>	Auflage- punkte <i>supporting points</i>	Güte 000 <i>tolerance class 000</i>			Güte 00 <i>tolerance class 00</i>			Güte 0 <i>tolerance class 0</i>		
			Art.-Nr. <i>Order no.</i>	Ebenheit <i>Evenness</i>	EUR	Art.-Nr. <i>Order no.</i>	Ebenheit <i>Evenness</i>	EUR	Art.-Nr. <i>Order no.</i>	Ebenheit <i>Evenness</i>	EUR
400x250x50 mm	15 kg	3	48-001	1,5 µm	329,00	48-021	3 µm	267,00	48-041	6 µm	234,00
400x400x50 mm	23 kg	3	48-002	1,5 µm	383,00	48-022	3 µm	319,00	48-042	6 µm	293,00
600x400x80 mm	56 kg	5	48-003	1,5 µm	539,00	48-023	3 µm	451,00	48-043	7 µm	414,00
600x600x80 mm	84 kg	5	48-004	1,5 µm	697,00	48-024	3 µm	569,00	48-044	7 µm	519,00
800x600x80 mm	111 kg	5	48-005	2 µm	916,00	48-025	4 µm	737,00	48-045	7 µm	663,00
1000x600x100 mm	174 kg	5	48-006	2 µm	1211,00	48-026	4 µm	1027,00	48-046	8 µm	837,00
1000x1000x120 mm	348 kg	5	48-008	2 µm	1769,00	48-028	4 µm	1626,00	48-048	8 µm	1495,00
1200x800x120 mm	335 kg	5	48-009	2,5 µm	1648,00	48-029	5 µm	1425,00	48-049	9 µm	1255,00
1500x1000x160 mm	696 kg	5	48-011	2,5 µm	2716,00	48-031	5 µm	2526,00	48-051	10 µm	2160,00
2000x1000x200 mm	1160 kg	5	48-013	3 µm	3925,00	48-033	6 µm	3545,00	48-053	12 µm	3165,00

Weitere Größen auf Anfrage!
Further sizes on request!

OELZE Schrankunterbau für Messplatte *Cabinet as sub-construction for hard stone plate*

als Unterbau für OELZE-Messplatten und deren problemloses Einnivellieren | Stauraum für Werkzeuge und Messmittel | stabile Stahlblechkonstruktion | rollengelagerte Schubladen | abschließbare Türen | Stellfüße zum Ausgleich von Bodenunebenheiten | Arbeitshöhe der gelagerten Platte ca. 900 mm | strukturlackiert grau
as sub-construction for OELZE hard stone plates for trouble-free leveling | storage space for tools and measuring equipment | solid sheet steel case | drawer mounted on roller bearings | lockable doors | adjustable base for compensation of floor unevenness | working height approx. 900 mm | structured coating grey



48-103

Art.-Nr. <i>Order no.</i>	für Messplatte <i>for hard stone plate</i>	Typ <i>type</i>	Gewicht <i>weight</i>	EUR
48-101	600x400 mm	1 Tür, 1 Schublade <i>1 door, 1 drawer</i>	44 kg	512,00
48-102	600x600 mm 800x600 mm		52 kg	546,00
48-103*	1000x600 mm 1200x800 mm	2 Türen, 2 Schubladen <i>2 doors, 2 drawers</i>	75 kg	631,00
48-104*	1000x1000 mm		84 kg	988,00
48-105	1500x1000 mm		98 kg	860,00
48-106*	2000x1000 mm	3 Türen, 2 Schubladen <i>3 doors, 2 drawers</i>	126 kg	922,00

*mit zusätzlichem Zwischenfach *with additional shelf*

Messtische, Stative, Schraubstöcke, Parallelunterlagen Granite plates, dial stands, bench vices, parallel supports

OELZE Gestell für Messplatte *Support stand for hard stone plate*

als Unterbau für OELZE-Messplatten und deren problemloses Einnivellieren | Schweißkonstruktion aus Profilstahl | Arbeitshöhe der gelagerten Platte ca. 900 mm | strukturlackiert grau | Made in Germany



48-113

as sub-construction for OELZE hard stone plates for trouble-free leveling | welded design from section steel | working height approx. 900 mm | structured coating grey | Made in Germany



Art.-Nr. Order no.	für Messplatte for hard stone plate	Gewicht weight	EUR
48-111	600x400 mm	24 kg	238,00
48-112	600x600 mm 800x600 mm	27 kg	252,00
48-113	1000x600 mm 1200x800 mm	35 kg	266,00
48-114	1000x1000 mm	36 kg	347,00
48-115	1500x1000 mm	52 kg	377,00
48-116	2000x1000 mm	55 kg	449,00

OELZE Einzelstütze für Messplatte *Leg support for hard stone plate*



48-125

zum spannungsfreien Aufstellen und Einnivellieren von OELZE-Messplatten auf eine arbeitsgerechte Höhe | Grauguß | für Messplatten ab 600x600 mm | strukturlackiert grau
for stress-free mounting and leveling of OELZE hard stone plates to ergonomic height | gray cast iron | for hard stone plates from 600x600 mm | structured coating grey



Art.-Nr. Order no.	Verstellbereich (Höhe) adjustable height	Standfläche base area	Gewicht weight	EUR
48-121	130-155 mm	Ø90 mm	3 kg	111,00
48-122	260-300 mm	220x220 mm	13 kg	148,00
48-123	350-390 mm		17 kg	205,00
48-124	470-510 mm	260x260 mm	24 kg	239,00
48-125	570-610 mm		20 kg	249,00
48-126	620-660 mm		23 kg	295,00
48-127	720-760 mm	280x280 mm	26 kg	322,00

Reinigungsmittel für Hartgesteinsprodukte *Cleaning compound for hard stone products*



NOVALINE: spezielles Reinigungsmittel zur schonenden Reinigung von Hartgestein-Produkten | umweltverträglich und wasserlöslich
NOVALINE: special cleaning compound for gentle cleaning of hard stone products | environment friendly and water soluble

48-191

Art.-Nr. Order no.	Menge quantity	Typ type	EUR	Grundpreis pro l (EUR) basis price per l (EUR)
48-191	0,5 l	Sprühflasche, nachfüllbar aerosol can, refillable	9,50	19,00
48-192	5 l	Kunststoffkanister plastic canister	79,50	15,90



Das Sicherheitsdatenblatt zu diesem Produkt können Sie auf www.quality-tools.de im Bereich „Downloads“ herunterladen!
The safety data sheet of this product can be downloaded from www.quality-tools.de on the side "Downloads"!



NOVAFLIES: flusenfreies Mikrofaserstuch für die schonende Reinigung von Hartgestein | Größe 40x40 cm | besondere Saugfähigkeit | waschbar (bis 60°C) | scheuerfest

NOVAFLIES: lint-free microfiber fabric for gentle cleaning of hard stone | size 40x40 cm | unique absorptive capacity | washable (up to 60°C) | high abrasion resistance

Art.-Nr. Order no.	EUR
48-195	4,90

Messtische, Stative, Schraubstöcke, Parallelunterlagen Granite plates, dial stands, bench vices, parallel supports

Hartgestein-Winkelnormale *Hard stone square standards*

90°-Winkelnormal | Toleranzklasse 0 | rechteckig, quadratisch oder würfelförmig | inkl. Hersteller-Prüfprotokoll
90° standard | tolerance class 0 | rectangular, quadratic or cubical | incl. manufacturers inspection certificate



Art.-Nr. Order no.	Abmessung dimensions	Form design	Gewicht weight	EUR
20-031	300x200x20 mm	Rechteckig/quadratisch Rectangular/quadratic	8 kg	188,00
20-032	400x250x60 mm		17 kg	359,00
20-033	400x400x60 mm		23 kg	485,00
20-034	500x500x70 mm		37 kg	698,00
20-035	600x300x80 mm		37 kg	756,00
20-036	600x600x80 mm		68 kg	910,00
20-037	800x400x100 mm		75 kg	985,00
20-038	800x800x100 mm		150 kg	1285,00
20-039	1000x500x120 mm		130 kg	1780,00
20-051	150x150x150 mm	Würfel cubical	10 kg	248,00
20-052	300x300x300 mm		78 kg	594,00
20-053	400x400x400 mm		185 kg	955,00
20-054	500x500x500 mm		368 kg	1365,00

HELIOS-PREISSER Prüfplatte aus Grauguss *Grey cast iron plate*

Spezialguss | Ebenheit nach DIN 876 | Güte 0: Oberfläche geschabt, Güte 1: Oberfläche feinstgeschliffen, Güte 3: Oberfläche Strahlenschliff | verwindungssteife Rippenkonstruktion | Made in Germany

Special cast iron | evenness according to DIN 876 | tolerance class 0: surface pared, tolerance class 1: surface ultrafine ground, tolerance class 3; surface ground | warp resistant ribbed design | Made in Germany



Abmessungen dimensions	Güte 0 tolerance class 0		Güte 1 tolerance class 1		Güte 3 tolerance class 3	
	Art.-Nr. Order no.	EUR	Art.-Nr. Order no.	EUR	Art.-Nr. Order no.	EUR
200x200 mm	46-801	168,00	46-811	132,00	46-831	98,00
300x300 mm	46-802	295,00	46-812	219,00	46-832	159,00
400x300 mm	46-803	369,00	46-813	295,00	46-833	190,00
400x400 mm	46-804	482,00	46-814	369,00	46-834	229,00
500x400 mm			46-815	415,00	46-835	295,00
500x500 mm			46-816	535,00	46-836	435,00
600x500 mm			46-817	590,00	46-837	482,00
800x500 mm			46-818	980,00	46-838	687,00
1000x600 mm			46-819	1745,00	46-839	1090,00

HELIOS-PREISSER Gestell für Prüfplatte *Support stand for grey cast iron plate*



für HELIOS-PREISSER Prüfplatten ab 400x400 mm | Made in Germany
for HELIOS-PREISSER grey cast iron plates from 400x400 mm |
Made in Germany



Art.-Nr. Order no.	für Prüfplatte for cast iron plate	EUR
46-844	400x400 mm	318,00
46-845	500x400 mm	318,00
46-846	500x500 mm	339,00
46-847	600x500 mm	358,00
46-848	800x500 mm	399,00
46-849	1000x600 mm	485,00

Messtische, Stative, Schraubstöcke, Parallelunterlagen

Granite plates, dial stands, bench vices, parallel supports

Magnet-Messstativ *Magnetic measuring stand*



schaltbarer Magnetfuß | mit Feineinstellung | Aufnahmebohrung Ø8 mm | Magnetkraft 60 kg
magnet base with switch on/off | with fine adjustment | seat hole Ø8 mm | magnet force 60 kg

Art.-Nr. Order no.	Säule pillar	Gesamthöhe total height	Querarm Transverse arm	Magnet Abmessungen Magnet dimensions	Magnet- Aufnahme Magnet connection	EUR
30-001	Ø12x173 mm	230 mm	Ø10x150 mm	63x50x55 mm	M8	17,80
30-002	Ø16x226 mm	280 mm	Ø12x200 mm	63x50x55 mm	M10	21,80



Achtung! Maximale Magnetkraft wird nur bei min. 15 mm starkem blankem Stahl-Untergrund erreicht!
Caution! Maximum magnetic force is only available at min. 15 mm strong blank steel ground!

Magnet-Messstativ **schwere Ausführung** *Magnetic measuring stand heavy model*



schaltbarer Magnetfuß | mit Feineinstellung | Aufnahmebohrung Ø8 mm
magnet base with switch on/off | with fine adjustment | seat hole Ø8 mm

Art.-Nr. Order no.	Säule pillar	Gesamthöhe* total height*	Querarm Transverse arm	Magnet Abmessungen Magnet dimensions	Magnet- kraft magnet force	Magnet- Aufnahme Magnet connection	EUR
30-021	Ø16x230 mm	290 mm	Ø16x220 mm	63x50x55 mm	60 kg	M10	46,50
30-022	Ø20x420 mm	500 mm	Ø16x390 mm	75x60x80 mm	80 kg	M12	74,50

*inkl. Magnetfuß, ohne Querarm *incl. magnetic base, without transverse arm*



Achtung! Maximale Magnetkraft wird nur bei min. 15 mm starkem blankem Stahl-Untergrund erreicht!
Caution! Maximum magnetic force is only available at min. 15 mm strong blank steel ground!

Magnet-Gelenkmessstativ mit **Zentralklemmung** *Magnetic measuring hinge stand with central clamping*



schaltbarer Magnetfuß | mit Feineinstellung | mit mechanischer Zentralklemmung | Aufnahmebohrung Ø8 mm (für Messuhren) und Schwalbenschwanz-Aufnahme (für Fühlhebelmessgeräte)
magnet base with switch on/off | with fine adjustment | with mechanical central clamping | seat hole Ø8 mm (for dial gauges) and dovetail (for dial test indicators)

Art.-Nr. Order no.	Gesamthöhe total height	Magnet Abmessungen Magnet dimensions	Magnetkraft magnet force	EUR
30-011	380 mm	59x50x55 mm	60 kg	32,50
30-013		62x50x55 mm	80 kg	38,50
30-015	430 mm	62x50x55 mm	80 kg	78,00



Achtung! Maximale Magnetkraft wird nur bei min. 15 mm starkem blankem Stahl-Untergrund erreicht!
Caution! Maximum magnetic force is only available at min. 15 mm strong blank steel ground!

Magnet-Gelenkmessstativ **kleine Ausführung** *Magnetic measuring stand small model*



schaltbarer Magnetfuß | mit mechanischer Zentralklemmung | Aufnahmebohrung Ø8 mm (für Messuhren) und Schwalbenschwanz-Aufnahme (für Fühlhebelmessgeräte)
magnet base with switch on/off | with mechanical central clamping | seat hole Ø8 mm (for dial gauges) and dovetail (for dial test indicators)

Art.-Nr. Order no.	Gesamthöhe total height	Magnet Abmessungen Magnet dimensions	Magnetkraft magnet force	EUR
30-031	180 mm	36x30x36 mm	10 kg	34,80



Achtung! Maximale Magnetkraft wird nur bei min. 15 mm starkem blankem Stahl-Untergrund erreicht!
Caution! Maximum magnetic force is only available at min. 15 mm strong blank steel ground!

01

02

03

04

05

06

07

08

09

10

11

12

13

14

15

Messtische, Stative, Schraubstöcke, Parallelunterlagen Granite plates, dial stands, bench vices, parallel supports

Magnet-Messstativ mit flexiblem Gestänge *Flexible magnetic measuring stand*



schaltbarer Magnetfuß | mit mechanischer Zentralklemmung | mit Feineinstellung | Aufnahmebohrung Ø8 mm (für Messuhren) und Schwalbenschwanz-Aufnahme (für Fühlhebelmessgeräte)

magnet base with switch on/off | with mechanical central clamping | with fine adjustment | seat hole Ø8 mm (for dial gauges) and dovetail (for dial test indicators)

Art.-Nr. Order no.	Gesamthöhe* total height*	Magnet Abmessungen Magnet dimensions	Magnetkraft magnet force	EUR
30-033	420 mm	59x50x55 mm	60 kg	33,50

*inkl. Magnetfuß *incl. magnetic base*



Achtung! Maximale Magnetkraft wird nur bei min. 15 mm starkem blankem Stahl-Untergrund erreicht!
Caution! Maximum magnetic force is only available at min. 15 mm strong blank steel ground!

Messstativ mit Klemmzange *Measuring stand with clamping tongs*



Klemmzange für Blechstärke bis 60 mm | flexibles Gestänge mit mechanischer Zentralklemmung | mit Feineinstellung | Aufnahmebohrung Ø8 mm (für Messuhren) | Lieferung ohne Messuhr

Clamping tongs for plate thickness up to 60 mm | flexible measuring stand with mechanical central clamping | with fine adjustment | seat hole Ø8 mm (for dial gauges) | delivery without dial gauge

Art.-Nr. Order no.	Gesamthöhe total height	EUR
30-034	300 mm	31,80

Messstativ mit Vakuum-Sockel *Measuring stand with vacuum base*



Vakuum-Sockel Ø90 mm | mit mechanischer Zentralklemmung | mit Feineinstellung | Aufnahmebohrung Ø8 mm (für Messuhren) und Schwalbenschwanz-Aufnahme (für Fühlhebelmessgeräte)

vacuum base Ø90 mm | with mechanical central clamping | with fine adjustment | seat hole Ø8 mm (for dial gauges) and dovetail (for dial test indicators)

Art.-Nr. Order no.	Gesamtlänge total length	EUR
30-039	256 mm	49,50

Messtische, Stative, Schraubstöcke, Parallelunterlagen

Granite plates, dial stands, bench vices, parallel supports

Magnetfuß für Messstativ *Magnetic base for measuring stand*



mit Ein-/Ausschalter | Prismenfuß
with On-/Off-switch | prismatic base

30-061

Art.-Nr. Order no.	Magnetkraft Magnetic force	Aufnahme- gewinde Thread	Abmessungen Dimensions	EUR
30-061	60 kg	M8	59x50x55 mm	12,80
30-062	80 kg		62x50x55 mm	15,50
30-063	100 kg		73x50x55 mm	21,50
30-064	60 kg	M10	59x50x55 mm	12,80
30-065	80 kg		62x50x55 mm	15,50
30-066	100 kg		73x50x55 mm	21,50



Achtung! Maximale Magnetkraft wird nur bei min. 15 mm starkem blankem Stahl-Untergrund erreicht!
Caution! Maximum magnetic force is only available at min. 15 mm strong blank steel ground!

Lamellen-Magnetfuß für Messstativ *Lamellar magnetic base for measuring stand*



für unebenen Untergrund | max. einstellbarer Höhenunterschied 15 mm | Aufnahmegewinde M8 |
Magnetkraft 60 kg | Abmessungen (LxBxH) 75x47x54 mm
or uneven ground | max. height difference 15 mm | Thread M8 | Magnetic force 60 kg | Dimensions
(LxWxH) 74x47x54 mm

Art.-Nr. Order no.	EUR
30-069	37,50



Achtung! Maximale Magnetkraft wird nur bei vollflächiger Auflage und min. 15 mm starkem blankem Stahl-Untergrund erreicht!
Caution! Maximum magnetic force is only available at full ground contact and min. 15 mm strong blank steel ground!

Dauermagnet-Fuß für Messstativ *Permanent magnetic base for measuring stand*



runder Dauermagnet-Fuß | Aufnahmegewinde M8
Round permanent magnetic base | thread M8

30-071

Art.-Nr. Order no.	Magnetkraft Magnetic force	Abmessungen Dimensions	EUR
30-071	12 kg	Ø50x10,5 mm	7,50
30-073	36 kg	Ø80x13 mm	11,80



Achtung! Maximale Magnetkraft wird nur bei min. 15 mm starkem blankem Stahl-Untergrund erreicht!
Caution! Maximum magnetic force is only available at min. 15 mm strong blank steel ground!

Verlängerung für Messstative *Extension for measuring stands*

zur Verlängerung der Standsäule | Durchmesser 16 mm | geeignet für alle Stative mit Gewinde M8
For extension of main column | diameter 16 mm | suitable for all stands with thread M8



30-081

Art.-Nr. Order no.	Länge Length	EUR
30-081	100 mm	7,80
30-082	200 mm	9,50

Messtische, Stative, Schraubstöcke, Parallelunterlagen Granite plates, dial stands, bench vices, parallel supports

FISSO Magnet-Messtativ *Magnetic measuring stand*



Produkt-Linie „BASE-LINE“ | schaltbarer Magnetfuß | mit Feineinstellung | mit mechanischer Zentralklemmung | Aufnahmebohrung Ø8 mm / Schwalbenschwanz | Swiss made | Lieferung ohne Messuhr
product line „BASE-LINE“ | magnet base with switch on/off | with fine adjustment | with mechanical central clamping | seat hole Ø8 mm / dove tail | Swiss made | delivery without dial gauge



Art.-Nr. Order no.	Säule pillar	max. Gesamthöhe* maximum height*	Magnet Abmessungen Magnet dimensions	Magnetkraft magnet force	EUR
41-002	Ø10 mm	277 mm	34x30x35 mm	300 N	119,00
41-003	Ø12 mm	367 mm	60x50x55 mm	750 N	129,00
41-004	Ø14 mm	453 mm			135,00

*inkl. Querarm *incl. transverse arm*

FISSO Magnet-Gelenkmesstativ *Magnetic measuring hinge stand*

Produkt-Linie „CLASSIC-LINE“ | schaltbarer Magnetfuß | mit Feineinstellung | mit mechanischer Zentralklemmung | Aufnahmebohrung Ø8 mm / Schwalbenschwanz | Swiss made | Lieferung ohne Messuhr
product line „CLASSIC-LINE“ | magnet base with switch on/off | with fine adjustment | with mechanical central clamping | seat hole Ø8 mm / dove tail | Swiss made | delivery without dial gauge



Art.-Nr. Order no.	Aktionsradius operating range	Magnet Abmessungen Magnet dimensions	Magnetkraft magnet force	EUR
41-023	200 mm	60x50x55 mm	800 N	198,00
41-024	280 mm			229,00
41-026	450 mm	75x50x55 mm	1000 N	411,00
41-027	630 mm	120x60x55 mm		645,00

FISSO Magnet-Gelenkmesstativ *Magnetic measuring hinge stand*

Produkt-Linie „STRATO-LINE“ | schaltbarer Magnetfuß | mit Feineinstellung | mit mechanischer Zentralklemmung | Aufnahmebohrung Ø8 mm / Schwalbenschwanz | Swiss made | Lieferung ohne Messuhr
product line „STRATO-LINE“ | magnet base with switch on/off | with fine adjustment | with mechanical central clamping | seat hole Ø8 mm / dove tail | Swiss made | delivery without dial gauge



Art.-Nr. Order no.	Aktionsradius operating range	Magnet Abmessungen Magnet dimensions	Magnetkraft magnet force	EUR
41-052	130 mm	34x30x35 mm	300 N	179,00
41-053	200 mm	60x50x55 mm	800 N	214,00
41-054	280 mm			278,00
41-055	280 mm	75x50x55 mm	1000 N	298,00

Messtische, Stative, Schraubstöcke, Parallelunterlagen

Granite plates, dial stands, bench vices, parallel supports

FISSO Messstativ-Baukastensystem *Measuring stand modular design*

Baukastensystem aus verschiedenen Füßen, Stativen und Messgeräte-Haltern für Ihr individuelles Messstativ | Swiss made
 Modular design with different bases, stands and holders for your individual measuring stand | Swiss made



Messgeräte-Halter *Holders for measuring devices*
 Messuhr-Aufnahme Ø8 mm / Schwalbenschwanz
 Seat hole Ø8 mm / dovetail



Art.-Nr. Order no.	Feineinstellung Fine adjustment	Anschlußgewinde Connection thread	EUR
41-101	ohne <i>without</i>	M6	17,50
41-102		M8	17,50
41-105	mit <i>with</i>	M6	31,80
41-106		M8	31,80

Anbau-Gelenkstative *Gauging arms*

Gelenk-Stativ „Strato Line“ <i>Gauging arm „Strato Line“</i>			
Art.-Nr. Order no.	Gesamt- länge Overall length	Gewinde unten/oben Thread Bottom/top	EUR
41-121	130 mm	M6/M6	99,00
41-122	200 mm	M8/M6	119,00
41-123	280 mm		183,00



Gelenk-Stativ „Classic Line“ <i>Gauging arm „Classic Line“</i>			
Art.-Nr. Order no.	Gesamt- länge Overall length	Gewinde unten/oben Thread Bottom/top	EUR
41-141	130 mm	M6/M6	92,50
41-142	197 mm	M8/M6	106,00
41-143	288 mm		136,00
41-144	407 mm	M8/M8	152,00
41-145	453 mm		295,00
41-146	635 mm		M10x1,25/M8

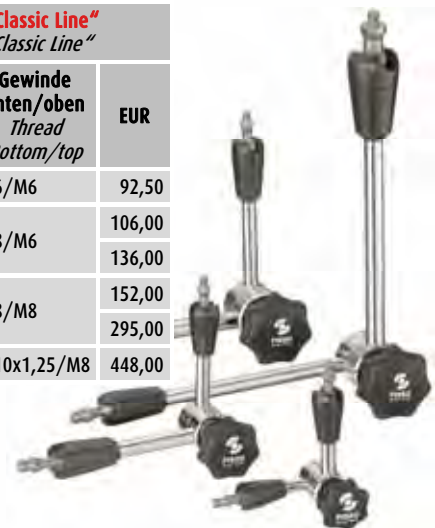

Füße *Bases*

Schaltbarer Magnet-Fuß <i>Switchable magnet base</i>				
Art.-Nr. Order no.	Gewinde thread	Abmessungen Dimensions	Magnetkraft magnet force	EUR
41-151	M6	34x30x35 mm	300 N	49,00
41-152		40x40x40 mm	600 N	58,00
41-153	M8	60x50x55 mm	800 N	62,50
41-154		75x50x55 mm	1000 N	84,00
41-155	M10x1,25	120x60x55 mm	1500 N	161,00
41-156		120x130x55 mm	2x 1500 N	429,00



Granit-Fuß <i>Granite base</i>			
Art.-Nr. Order no.	Gewinde thread	Abmessungen Dimensions	EUR
41-185	M8	150x120 x50x50 mm	349,00



Lamellen-Magnet-Fuß (für unebenen Untergrund) <i>Lamellar magnet base (for uneven ground)</i>				
Art.-Nr. Order no.	Gewinde thread	Abmessungen Dimensions	Magnetkraft magnet force	EUR
41-171	M8	77x48x55 mm	600 N	94,00
41-172*		91x52x55 mm		116,00



*schaltbar *switchable*

Dauermagnet-Fuß <i>Permanent magnet base</i>				
Art.-Nr. Order no.	Gewinde thread	Abmessungen Dimensions	Magnetkraft magnet force	EUR
41-161	M6	Ø30x25 mm	150 N	33,50
41-162	M8	Ø40x30 mm	300 N	37,50



Schaltbarer Vakuum-Fuß <i>Switchable vacuum base</i>			
Art.-Nr. Order no.	Gewinde thread	Abmessungen Dimensions	EUR
41-181	M8	Ø88x27 mm	119,00

Messtische, Stative, Schraubstöcke, Parallelunterlagen

Granite plates, dial stands, bench vices, parallel supports

Mini-Schraubstock *Mini bench vice*

Grundkörper aus Aluminium, blau eloxiert | Spannbacken mit vertikalen und horizontalen Prismen | Magnetfläche zur Teilefixierung
base made of aluminum, blue anodized | jaws with vertical and horizontal prisms | magnet for fixing parts



Art.-Nr. Order no.	Backenbreite jaw width	Spannweite range	EUR
60-577	15 mm	13 mm	88,00
60-576	25 mm	30 mm	98,00

Satz aus 60-577 und 60-576:
Set consisting of 60-577 and 60-576:

Art.-Nr. Order no.	EUR
60-578	169,00

Präzisions-Mini-Schraubstock *Precision mini bench vice*

Schraubstöcke *bench vices*

mit gehärteten rostfreien Stahl-Backen, einseitig mit Prisma (alle Varianten) | Messing- & Alu-Varianten zusätzlich inkl. 1 Paar Wechsel-Kunststoffbacken | Made in Germany

with hardened stainless jaws, one-sided with prism (all types) | Brass & aluminium types additional including 1 pair replacement jaws of plastics | Made in Germany



Art.-Nr. Order no.	Material	Backenbreite jaw width	Spannweite range	EUR
62-001	Messing matt verchromt <i>Brass satin chromed</i>	15 mm	14 mm	99,00
62-002	Aluminium eloxiert	25 mm	23 mm	139,00
62-003	Aluminium eloxiert	35 mm	32 mm	196,00
62-011	rostfreier Stahl INOX <i>stainless steel INOX</i>	15 mm	14 mm	148,00
62-012		25 mm	23 mm	246,00
62-013		35 mm	32 mm	275,00

Zubehör *Accessories*

Schraubstock-Ständer* *Stand for bench vice**

Art.-Nr. Order no.	für Backenbreite for jaw width	Grundplatte Base plate	EUR
62-051	15 / 25 mm	Ø70 mm	111,00
62-053	35 mm	Ø90 mm	129,00

*nur zusammen mit Trägerplatte einsetzbar!
**applicable only together with carrier plate!*



Trägerplatte (zwischen Ständer und Schraubstock) *Carrier plate (between stand and bench vice)*



Art.-Nr. Order no.	für Backenbreite for jaw width	Abmessungen dimensions	EUR
62-031	15 mm	52x17x8 mm	19,80
62-032	25 mm	77x27x8 mm	21,80
62-033	35 mm	102x37x8 mm	24,80

Schraubstock-Backen *Jaws for bench vice*

für Backenbreite for jaw width	Backentyp <i>Type of jaws</i>							
	Stahlbacken-Paar* Prisma & glatt (INOX) <i>Pair of steel jaws* prism & flat (INOX)</i>		Spannbacke INOX abgesetzt <i>Gripping jaw INOX reduced</i>		Prismabacke INOX mit Anschlagstift <i>Prism jaw INOX with stop pin</i>		Kunststoffbackenpaar POM Prisma & glatt <i>Pair of plastics jaws POM prism & flat</i>	
	Art.-Nr. Order no.	EUR	Art.-Nr. Order no.	EUR	Art.-Nr. Order no.	EUR	Art.-Nr. Order no.	EUR
15 mm	62-021A	26,50	62-021B	6,80	62-021C	9,80	62-021D	16,50
25 mm	62-022A	34,80	62-022B	9,80	62-022C	14,50	62-022D	19,80
35 mm	62-023A	44,50	62-023B	16,50	62-023C	21,00	62-023D	27,00

*Serienbacken
**standard jaws*



Koffer-Sätze *Sets in carrying case*



Art.-Nr. Order no.	Inhalt contents	EUR
62-094	3 Schraubstöcke 15/25/35 mm + Backensätze <i>3 bench vices 15/25/35 mm + set of jaws</i>	485,00
62-099	wie 62-094, zusätzlich 2 Ständer m. Trägerplatte, 2 Prismen m. Spannbügel, 2 Teilapparate <i>like 62-094, additional 2 stands with carrier plate, 2 prisms with bracket, 2 dividing heads</i>	1190,00

Messtische, Stative, Schraubstöcke, Parallelunterlagen Granite plates, dial stands, bench vices, parallel supports

Präzisionsschraubstock *Precision bench vice*

mit Gewindespindel | eingeschliffene Prismen (horizontal + vertikal) | Genauigkeit 0,005 mm / 100 mm
with threaded spindle | with ground-in prisms (horizontal + vertical) | accuracy 0.005 mm / 100 mm



Art.-Nr. Order no.	Backenbreite jaw width	Spannweite range	EUR
30-201	50 mm	60 mm	109,00
30-202	73 mm	85 mm	139,00
30-203	100 mm	127 mm	225,00
30-204	125 mm	160 mm	328,00

Präzisionsschraubstock mit Schnellverstellung *Precision bench vice with quick adjustment*

mit Niederzugbacken | mit eingeschliffenen Prismen | Genauigkeit 0,005 mm / 100 mm
with pull down jaws | with ground-in prisms | accuracy 0.005 mm / 100 mm



Art.-Nr. Order no.	Backenbreite jaw width	Spannweite range	EUR
30-221	25 mm	25 mm	64,50
30-222	50 mm	70 mm	83,50
30-223	73 mm	100 mm	107,00
30-224	100 mm	125 mm	178,00
30-225	125 mm	160 mm	267,00

Sinus-Schraubstock *Sinus vice*

mit Schnellverstellung | mit eingeschliffenen Prismen | Genauigkeit 0,005 mm / 100 mm
with quick adjustment | with ground-in prisms | accuracy 0.005 mm / 100 mm



Art.-Nr. Order no.	Backenbreite jaw width	Spannweite range	EUR
30-241	50 mm	65 mm	139,00
30-242	75 mm	100 mm	192,00
30-243	100 mm	125 mm	342,00

ACCUD Universal-Präzisions-Schraubstock **drehbar und schwenkbar** *Universal precision bench vice rotatable and pivoting*



ACCUD

drehbar 360°, Skalierung 0,05° | schwenkbar 45°, Skalierung 0,05° | Backenbreite 70 mm | Spannweite 80 mm | Grundplatte 178x110 mm | mit Gewindespindel | eingeschliffene Prismen (horizontal + vertikal) | Genauigkeit (Parallelität und Rechtwinkligkeit) 0,005 mm / 100 mm | aus gehärtetem Werkzeugstahl
rotatable 360°, scale 0.05° | pivoting 45°, scale 0.05° | jaw width 70 mm | range 80 mm | base 178x110 mm | with threaded spindle | with ground-in prisms (horizontal + vertical) | accuracy (parallelism and squareness) 0.005 mm / 100 mm | made of hardened tool steel

Art.-Nr. Order no.	EUR
70-501	945,00

Messtische, Stative, Schraubstöcke, Parallelunterlagen Granite plates, dial stands, bench vices, parallel supports

Prismenpaar *Pair of V-blocks*



Spezialstahl, paarweise geschliffen | Genauigkeit $\pm 0,01$ mm
special steel, ground by pairs | Accuracy ± 0.01 mm

Art.-Nr. Order no.	Abmessungen dimensions	für Wellen for shafts	EUR
30-101	75x40x40 mm	Ø5-40 mm	66,00
30-102	100x45x45 mm	Ø6-45 mm	84,50
30-103	150x55x55 mm	Ø8-55 mm	144,00

Prismenpaar mit Spannbügel *Pair of V-blocks with clamping bracket*



Spezialstahl, paarweise geschliffen | Genauigkeit $\pm 0,01$ mm
special steel, ground by pairs | Accuracy ± 0.01 mm

Art.-Nr. Order no.	Abmessungen dimensions	für Wellen for shafts	EUR
30-111	45x40x36 mm	Ø5-20 mm	61,50
30-112	70x45x40 mm	Ø5-25 mm	86,50
30-113	70x63x45 mm	Ø5-32 mm	122,00
30-114	125x90x70 mm	Ø5-45 mm	174,00

HELIOS-PREISSER Präzisions-Prismenpaar *Pair of precision V-blocks*

gehärteter Spezialstahl | Genauigkeit 0,004 mm (Parallelität zur Standfläche) | paarweise bearbeitet |
Made in Germany
hardened special steel | accuracy 0.004 mm (parallelism to base) | ground by pairs | Made in Germany



Art.-Nr. Order no.	Abmessungen dimensions	für Wellen for shafts	EUR
46-861	75x35x33 mm	Ø5-40 mm	129,00
46-862	100x47x40 mm	Ø5-55 mm	169,00
46-863	150x55x45 mm	Ø5-60 mm	228,00
46-864	200x65x55 mm	Ø5-75 mm	318,00
46-865	250x85x70 mm	Ø5-100 mm	435,00

HELIOS-PREISSER Prismenpaar mit Spannbügel, seitlich kippbar *Pair of V-blocks with clamping bracket, sideways tiltable*



gehärteter Spezialstahl | Genauigkeit 0,004 mm (Ebenheit, Parallelität, Symmetrie) / 0,01 mm
(Rechtwinkligkeit) | paarweise bearbeitet | seitlich kippbar | Made in Germany
hardened special steel | accuracy 0.004 mm (evenness, parallelism, symmetry) / 0.01 mm
(rectangularity) | ground by pairs | sideways tiltable | Made in Germany



Art.-Nr. Order no.	Abmessungen dimensions	für Wellen for shafts	EUR
46-881	60x58x40 mm	Ø5-30 mm	219,00
46-882	75x70x54 mm	Ø5-50 mm	273,00
46-883	100x96x75 mm	Ø7-70 mm	409,00

Messtische, Stative, Schraubstöcke, Parallelunterlagen

Granite plates, dial stands, bench vices, parallel supports

Magnet-Mess- und Spannprisma klein *Magnetic V-block small*



Magnet ein- und ausschaltbar | Magnetkraft 56 kg | für Wellen Ø6-44 mm | Genauigkeit ±0,01 mm
magnet with switch on/off | magnet force 56 kg | for shafts Ø6-44 mm | Accuracy ±0.01 mm

Art.-Nr. Order no.	Abmessungen dimensions	EUR
30-120	70x60x73 mm	57,00



Achtung! Maximale Magnetkraft wird nur bei min. 15 mm starkem blankem Stahl-Untergrund erreicht!
Caution! Maximum magnetic force is only available at min. 15 mm strong blank steel ground!

Magnet-Mess- und Spannprisma *Magnetic V-block*



Magnet ein- und ausschaltbar | Magnetkraft 100 kg | Einschnittwinkel 90° | Genauigkeit ±0,01 mm
magnet with switch on/off | magnet force 100 kg | slot angle 90° | Accuracy ±0.01 mm

Art.-Nr. Order no.	Abmessungen dimensions	EUR
30-121	96x66x100 mm	89,00



Achtung! Maximale Magnetkraft wird nur bei min. 15 mm starkem blankem Stahl-Untergrund erreicht!
Caution! Maximum magnetic force is only available at min. 15 mm strong blank steel ground!

Magnet-Mess- und Spannrisenpaar *Pair of magnetic V-blocks*

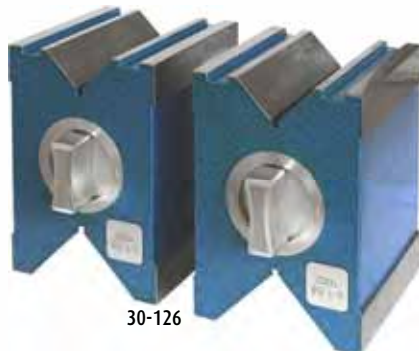

Magnet ein- und ausschaltbar | paarweise geschliffen | seitliche Anschlagfläche 90° |
 Genauigkeit ±0,005 mm
magnet with switch on/off | ground by pairs | locating surface at the side 90° | Accuracy ±0.005 mm

Art.-Nr. Order no.	Abmessungen dimensions	Magnetkraft magnet force	EUR
30-126	80x67x100 mm	100 kg	549,00
30-127	100x70x96 mm	120 kg	785,00



Achtung! Maximale Magnetkraft wird nur bei min. 15 mm starkem blankem Stahl-Untergrund erreicht!
Caution! Maximum magnetic force is only available at min. 15 mm strong blank steel ground!

HELIOS-PREISSER Magnet-Mess- und Spannprisma *Magnetic V-block*

gehärteter Spezialstahl | für Wellen Ø6-66 mm | Genauigkeit 0,004 mm (Ebenheit, Parallelität) / 0,01 mm
 (Rechtwinkligkeit) | schaltbarer Magnet | Haftkraft 600 N | paarweise geschliffen (nur 46-897) | Made in Germany
*hardened special steel | for shafts Ø6-66 mm | accuracy 0.004 mm (evenness, parallelism) / 0.01 mm
 (rectangularity) | switchable magnet | magnetic force 600 N | ground by pairs (only 46-897) | Made in Germany*



46-893

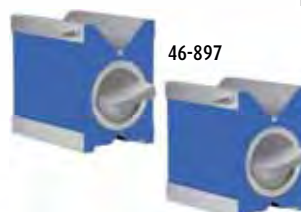

46-897

Art.-Nr. Order no.	Abmessungen dimensions	Typ type	EUR
46-893	80x67x96 mm	einzel <i>single</i>	395,00
46-897		Paar <i>pair</i>	849,00

Messtische, Stative, Schraubstöcke, Parallelunterlagen Granite plates, dial stands, bench vices, parallel supports

Parallelunterlagen-Satz mit konstanter Breite *Parallel supports set with constant width*

aus gehärtetem Stahl | paarweise geschliffen | Höhentoleranz $\pm 0,01$ mm | im Holzkasten
from hardened steel | ground by pairs | tolerance of height ± 0.01 mm | in wooden box



33-003

Art.-Nr. Order no.	Anzahl Paare number of pairs	Länge length	Breite width	Höhe (mm) height (mm)	EUR
33-001	9	100 mm	4 mm	10/14/18/22/26/ 30/34/38/42	89,50
33-004		160 mm			169,00
33-003	14	150 mm	10 mm	14/16/18/20/22/24/ 26/28/30/32/35/40/ 45/50	175,00

Parallelunterlagen-Satz mit unterschiedlicher Breite *Parallel supports set with differing width*

aus gehärtetem Stahl | paarweise geschliffen | Höhentoleranz $\pm 0,01$ mm | im Holzkasten
from hardened steel | ground by pairs | tolerance of height ± 0.01 mm | in wooden box



33-012

Art.-Nr. Order no.	Anzahl Paare number of pairs	Länge length	Abmessungen (mm) dimensions (mm)	EUR
33-010	20	100 mm	2x5/2x10/2x15/2x20/ 3x6/3x11/3x16/3x21/ 4x7/4x12/4x17/4x22/ 5x8/5x13/5x18/5x23/ 6x9/6x14/6x19/6x24	185,00
33-011	24	125 mm	8x11/8x16/8x21/8x26/8x31/8x36/ 10x13/10x18/10x23/10x28/10x33/ 10x38/12x15/12x20/12x25/12x30/ 12x35/12x40/14x17/14x22/14x27/ 14x32/14x37/14x42	234,00
33-012		150 mm		269,00

HELIOS-PREISSER Parallelunterlagen-Satz *Parallel supports set*

aus gehärtetem Spezialstahl | paarweise geschliffen | Höhentoleranz $\pm 0,005$ mm | im Holzkasten
hardened special steel | ground by pairs | tolerance of height ± 0.005 mm | in wooden box



46-874

Art.-Nr. Order no.	Anzahl Paare number of pairs	Länge length	Breite width	Höhe (mm) height (mm)	EUR
46-871	9	100 mm	4 mm	10/14/18/22/26/ 30/34/38/42	99,00
46-872		150 mm			138,00
46-873	12	120 mm	10 mm	14/16/18/20/22/24/ 26/28/30/32/35/40	383,00
46-874	14	150 mm	10 mm	14/16/18/20/22/24/ 26/28/30/32/35/40/ 45/50	429,00

Weitere Größen auf Anfrage!
Further sizes on request!

Messtische, Stative, Schraubstöcke, Parallelunterlagen

Granite plates, dial stands, bench vices, parallel supports

Parallelunterlagen Einzel-Paare *Parallel supports single pairs*

aus gehärtetem Spezial-Stahl | paarweise fein geschliffen | Höhentoleranz $\pm 0,01$ mm | restliche Maße nach DIN ISO 2768m
from hardened special steel | fine ground by pairs | tolerance of height ± 0.01 mm | other dimensions according to DIN ISO 2768m



33-118

Länge 100 mm <i>Length 100 mm</i>			
Art.-Nr. <i>Order no.</i>	Höhe <i>height</i>	Breite <i>width</i>	EUR
33-105	5 mm	2 mm	13,50
33-106	6 mm	3 mm	13,50
33-107	7 mm	4 mm	13,50
33-108	8 mm	5 mm	13,50
33-109	9 mm	6 mm	13,50
33-110	10 mm	2 mm	13,50
33-111	11 mm	3 mm	13,50
33-112	12 mm	4 mm	13,50
33-113	13 mm	5 mm	13,50
33-114	14 mm	6 mm	13,50
33-115	15 mm	2 mm	13,50
33-116	16 mm	3 mm	13,50
33-117	17 mm	4 mm	13,50
33-118	18 mm	5 mm	13,50
33-119	19 mm	6 mm	13,50
33-120	20 mm	2 mm	13,50
33-121	21 mm	3 mm	13,50
33-122	22 mm	4 mm	13,50
33-123	23 mm	5 mm	13,50
33-124	24 mm	6 mm	13,50

Länge 150 mm <i>Length 150 mm</i>			
Art.-Nr. <i>Order no.</i>	Höhe <i>height</i>	Breite <i>width</i>	EUR
33-311	11 mm	8 mm	21,00
33-313	13 mm	10 mm	21,00
33-315	15 mm	12 mm	21,00
33-316	16 mm	8 mm	21,00
33-317	17 mm	14 mm	21,00
33-318	18 mm	10 mm	21,00
33-320	20 mm	12 mm	21,00
33-321	21 mm	8 mm	21,00
33-322	22 mm	14 mm	21,00
33-323	23 mm	10 mm	21,00
33-325	25 mm	12 mm	21,00
33-326	26 mm	8 mm	23,00
33-327	27 mm	14 mm	23,00
33-328	28 mm	10 mm	23,00
33-330	30 mm	12 mm	23,00
33-331	31 mm	8 mm	23,00
33-332	32 mm	14 mm	23,00
33-333	33 mm	10 mm	23,00
33-335	35 mm	12 mm	27,00
33-336	36 mm	8 mm	27,00
33-337	37 mm	14 mm	27,00
33-338	38 mm	10 mm	27,00
33-340	40 mm	12 mm	27,00
33-342	42 mm	14 mm	27,00

01

02

03

04

05

06

07

08

09

10

11

12

13

14

15

Messtische, Stative, Schraubstöcke, Parallelunterlagen Granite plates, dial stands, bench vices, parallel supports

Sinuslineal Sine bar

zum Einstellen von Winkeln nach dem Sinusprinzip | mit Stützzyllindern | mit einseitigem Anschlag (abnehmbar) | Einstellbereich 0-60° | Parallelität 2,5 µm | mit Tabellen | Aufbewahrungsbox

for setting up angles according to the sine principle | with pillar supports | with stopper to one side (removable) | range 0-60° | parallelism 2.5 µm | with documents | box



Art.-Nr. Order no.	Auflagen- abstand distance between supports	Breite x Höhe Width x height	Genauigkeit Accuracy	EUR
30-246	100 mm	24x32 mm	2 µm	88,50
30-247	200 mm	25x50 mm	4 µm	169,00

HELIOS-PREISSER Sinuslineal Sine bar

zum Einstellen von Winkeln nach dem Sinusprinzip | DIN 2273 | mit Anschlag | mit Tabellen | Toleranz Rollenabstand 0,002 mm (100 mm) / 0,004 mm (200 mm)

for setting up angles according to the sine principle | DIN 2273 | with stopper | with documents | tolerance distance between supports 0.002 mm (100 mm) / 0.004 mm (200 mm)



Art.-Nr. Order no.	Auflagen- abstand distance between supports	EUR
46-852	100 mm	184,00
46-854	200 mm	215,00

HELIOS-PREISSER Schwenkprisma Pivoting prism

gehärteter Spezialstahl | mit Feststellung | Ablesung über Nonius
hardened special steel | with locking device | reading through nonius

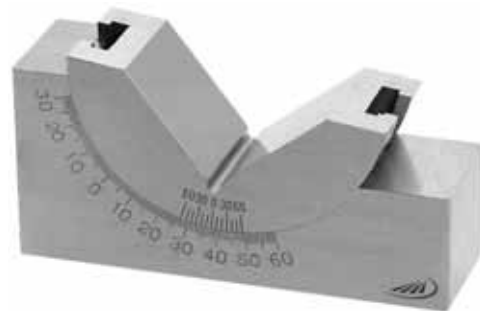

Art.-Nr. Order no.	Abmessungen dimensions	für Wellen for shafts	EUR
46-885	75x25x33 mm	Ø28 mm	118,00
46-886	102x30x46 mm	Ø40 mm	125,00
46-887	102x46x46 mm	Ø40 mm	134,00

Messzeug-Sätze

Measuring tool sets



- 01
- 02
- 03
- 04
- 05
- 06
- 07
- 08
- 09
- 10
- 11**
- 12
- 13
- 14
- 15

Inhalt *Contents*



11.2



11.2



11.5



11.5

Messzeug-Sätze Measuring tool sets

Messzeug-Satz „Messschieber + Tiefenmessbrücke“ Measuring tool set „caliper + depth measuring base“

2teilig | rostfrei | mit Aufbewahrungsbox
2 parts | stainless | box



Inhalt:
-Digital-Messschieber 150/0,01 mm
nach DIN 862
Datenausgang RB5
-Tiefenmessbrücke 75 mm

Content:
-digital caliper 150/0,01 mm
according to DIN 862
data output RB5
-depth measuring base 75 mm

Art.-Nr. Order no.	EUR
20-200	34,80

Präzisions-Messzeug-Satz „Basic“ Precision measuring tool set „Basic“

4teilig | rostfrei | mit Aufbewahrungsbox
4 parts | stainless | box



Inhalt:
-Taschenmessschieber 150 mm mit Momentverstellung
-Bügelmessschraube 0-25 mm, mattverchromt
-Haarwinkel 100x70 mm
-Maßstab 150 mm

Content:
-Vernier caliper 150 mm with auto lock
-Micrometer 0-25 mm, satin chrome finished
-knife edge square 100x70 mm
-ruler 150 mm

Art.-Nr. Order no.	EUR
20-216	62,50

Präzisions-Messzeug-Satz „Analog“ Precision measuring tool set „Analog“

6teilig | rostfrei | mit Aufbewahrungsbox
6 parts | stainless | box



Inhalt:
-Taschenmessschieber 150 mm mit Momentverstellung
-Bügelmessschraube 0-25 mm, mattverchromt
-Haarwinkel 100x70 mm
-Haarlineal 100 mm
-Maßstab 150 mm
-Zirkel 150 mm

Content:
-Vernier caliper 150 mm with auto lock
-Micrometer 0-25 mm, satin chrome finished
-knife edge square 100x70 mm
-straight edge 100 mm
-ruler 150 mm
-compasses 150 mm

Art.-Nr. Order no.	EUR
20-221	98,50

Messzeug-Sätze Measuring tool sets

Präzisions-Messzeug-Satz „Digital“ Precision measuring tool set „Digital“

6teilig | rostfrei | mit Aufbewahrungsbox
6 parts | stainless | box



Art.-Nr. Order no.	EUR
20-222	106,00

Inhalt:

- digitaler Taschenmessschieber 150 mm
- Bügelmessschraube 0-25 mm, mattverchromt (analog)
- Haarwinkel 100x70 mm
- Haarlineal 100 mm
- Maßstab 150 mm
- Zirkel 150 mm

Content:

- Digital caliper 150 mm
- Micrometer 0-25 mm, satin chrome finished (analog)
- knife edge square 100x70 mm
- straight edge 100 mm
- ruler 150 mm
- compasses 150 mm

HELIOS-PREISSER Präzisions-Messzeug-Satz Precision measuring tool set

8teilig | rostfrei | verschiedene Messschieber zur Wahl | mit Holzsetzi
8 parts | stainless | several calipers selectable | wooden box



46-121



Art.-Nr. Order no.	Messschieber Caliper	EUR
46-121	analog	129,50
46-123	digital	191,00
46-125	digital IP67 (wasserdicht waterproof)	215,00



enthalten bei included in
46-123/46-125

Inhalt:

- Messschieber 150 mm (verschiedene Modelle wählbar)
- Bügelmessschraube 0-25 mm, Ablesung 0,01 mm
- Maßstab 200 mm
- Haarwinkel 100x70 mm
- Haarlineal 100 mm
- Reißnadel, Hartmetallspitze
- Radienschablone, 17 Blatt, 1,0-7,0 mm
- Gewindeschablone, 48 Blatt, ISO-/Whitworthgewinde

Content:

- caliper 150 mm (several models selectable)
- micrometer 0-25 mm, reading 0.01 mm
- ruler 200 mm
- knife edge square 100x70 mm
- straight edge 100 mm
- scriber, carbide tip
- radius gauge, 17 blades, 1.0-7.0 mm
- thread master plate, 48 blades, ISO-/Whitworth threads

Messzeug-Sätze

Measuring tool sets

Präzisions-Messzeug-Satz 12teilig *Precision measuring tool set 12 parts*

12teilig | umfangreiches Messwerkzeug-Set für viele Messaufgaben | mit Aufbewahrungskoffer
 12 parts | wide range of measuring tools for various measuring tasks | box

Art.-Nr. Order no.	EUR
20-229	189,00



Inhalt:

- digitaler Taschenmessschieber 150 mm, Tiefenmessbrücke
- Bügelmessschraube 0-25 mm
- Messuhr 0-10 mm / 0,01 mm, Magnet-Messstativ
- Haarwinkel 100x70 mm, Winkelmesser
- Radiuslehre, Fühlerlehre, Gewindesteigungslehre
- Anreißnadel

Content:

- Digital caliper 150 mm, depth base
- Micrometer 0-25 mm
- dial gauge 0-10 mm / 0.01 mm, magnetic measuring stand
- knife edge square 100x70 mm, protractor
- radius gauge, feeler gauge, thread pitch gauge
- scriber

Präzisions-Messzeug-Satz „Messuhr+Stativ“ *Precision measuring tool set „Dial Gauge+Stand“*

2teilig | rostfrei | mit Aufbewahrungsbox
 2 parts | stainless | box

Art.-Nr. Order no.	EUR
20-226	48,50



Inhalt:

- Messuhr 0-10 mm, Ablesung 0,01 mm
- Magnet-Messstativ, Gesamthöhe 280 mm, Magnetkraft 60 kg

Content:

- dial gauge 0-10 mm, Reading 0.01 mm
- magnetic stand, total height 280 mm, magnetic force 60 kg

Präzisions-Messzeug-Satz „Feintaster+Stativ“ *Precision measuring tool set „Dial test indicator+Stand“*

2teilig | rostfrei | mit Aufbewahrungsbox
 2 parts | stainless | box

Art.-Nr. Order no.	EUR
20-227	89,00



Inhalt:

- Fühlhebelmessgerät 0-0,8 mm, Ablesung 0,01 mm
- Magnet-Messstativ, Gesamthöhe 180 mm, Magnetkraft 10 kg

Content:

- dial test indicator 0-0.8 mm, Reading 0.01 mm
- magnetic stand, total height 180 mm, magnetic force 10 kg

Messzeug-Sätze

Measuring tool sets

Präzisions-Messzeug-Satz „Haarlineal/Haarwinkel“ Precision measuring tool set „knife edge squares/ruler“

Steilig | rostfrei | Güte 00 | mit Aufbewahrungsbox
 5 parts | stainless | tolerance class 00 | box



Inhalt:

- Haarwinkel 75x50 mm
- Haarwinkel 40x28 mm
- Haarwinkel 25x20 mm
- Haarlineal 100 mm
- Anreißspitze 45 mm

Content:

- knife edge square 75x50 mm
- knife edge square 40x28 mm
- knife edge square 25x20 mm
- straight edge 100 mm
- scriber 45 mm

Art.-Nr. Order no.	EUR
20-201	96,00

HELIOS-PREISSER Lehren-Set Gauge set

8teilig | mit Holzetui
 8 parts | wooden box



Art.-Nr. Order no.	EUR
46-900	79,50

Inhalt:

- Radiuslehre 1,0 - 7,0 mm
- Radiuslehre 7,5- 15,0 mm
- Radiuslehre 15,5- 25,0 mm
- Gewindefschablone metrisch
- Gewindefschablone Whitworth-Gewinde
- Fühlerlehren 0,05 - 1,00 mm
- Schleiflehre
- Schweißnahtlehre

Content:

- radius gauge 1.0 - 7.0 mm
- radius gauge 7.5 - 15.0 mm
- radius gauge 15.5 - 25.0 mm
- thread master plates metric
- thread master plates Whitworth
- Feeler gauge 0.05 - 1.00 mm
- grinding gauge
- welding seam gauge

01



02



03



04



05



06



07



08



09



10



11



12



13



14



15



Lupen, Leuchten, Mikroskope

Loupes, lamps, microscopes



Inhalt Contents



12.2



12.8



12.9



12.10



12.13



12.15



12.16



12.21



12.23

Kalibrierung Calibration

Wir kalibrieren Ihr Messmikroskop! Lassen Sie sich ein individuelles Angebot machen...
We calibrate your measuring microscope! Please ask for an individual offer...

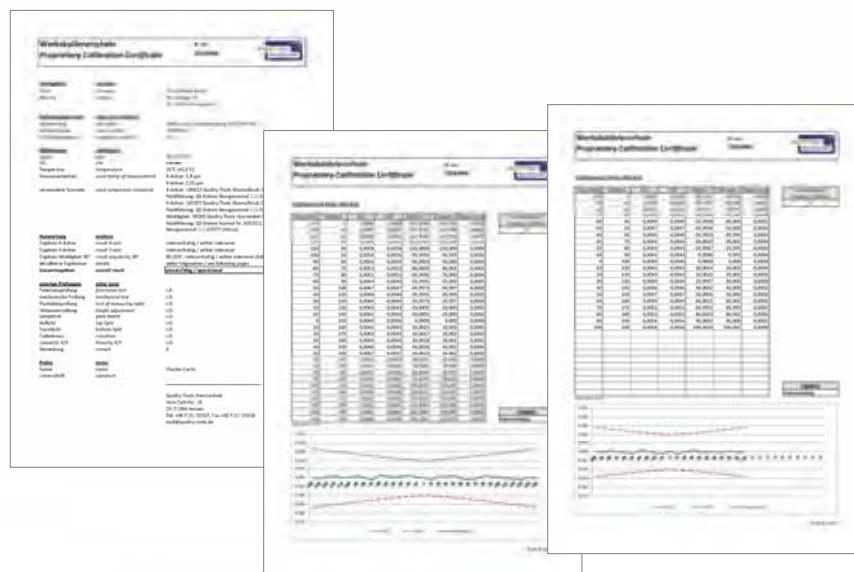

Lupen, Leuchten, Mikroskope Loupes, lamps, microscopes

Untersuchungsspiegel *Inspection mirror*

für Untersuchungen an schwer sichtbaren Stellen | Spiegel Ø20 mm | Grifflänge 200 mm | Stahlgriff
for inspection in hard-to-see locations | mirror Ø20 mm | length of handle 200 mm | steel handle



Art.-Nr. Order no.	EUR
60-741	5,90

Vergrößerungs-Untersuchungsspiegel mit Teleskopstab *Magnifying inspection mirror with telescoping handle*

für Untersuchungen an schwer sichtbaren Stellen | Spiegel Ø20 mm mit 2x-Vergrößerung | Teleskop-Griff Ø10 mm ausziehbar 130-475 mm | mit Ansteck-Clip
for inspection in hard-to-see locations | mirror Ø20 mm with 2x magnification | telescoping handle Ø10 mm length 130-475 mm | with clip



Art.-Nr. Order no.	EUR
60-743	12,50

Untersuchungsspiegel mit LED-Beleuchtung *Inspection mirror with LED illumination*

für Untersuchungen an dunklen Stellen | Spiegel ca. 28,5x53 mm | Gesamtlänge ca. 540 mm | flexible Stange | Griff Ø16 mm | Spiegel abnehmbar zum Einsatz als flexible Lichtquelle | inkl. Batterien
for inspection in dark locations | mirror approx. 28.5x53 mm | total length approx. 540 mm | flexible rod | handle Ø16 mm | mirror removable for use as flexible light | incl. batteries



Art.-Nr. Order no.	EUR
60-748	39,50

Lupe 3fach *Loupe 3x magnification*

Vergrößerung 3x | Linse Ø75 mm | Rahmen aus Metall
Magnification 3x | lens Ø75 mm | frame made of metal



Art.-Nr. Order no.	EUR
60-718	3,50

Lupe 2fach und 4fach *Loupe 2x and 4x magnification*

eine Linse mit 2 unterschiedlichen Vergrößerungen: 2x und 4x | große Linse Ø90 mm | Leichtbauweise (Linse: Polyacrylatharz, Griff und Rahmen: Kunststoff)
One lens for two magnifications: 2x and 4x | large lens Ø90 mm | lightweight (lens: acrylic resin, handle and frame: plastic)

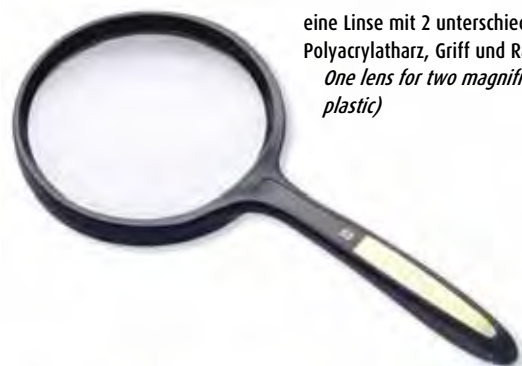

Art.-Nr. Order no.	EUR
60-704	12,90

Lupen, Leuchten, Mikroskope

Loupes, lamps, microscopes

Lupe mit starker Vergrößerung High magnification loupe



Linse: Glas | Fassung: PVC | Made in Japan
 Lens: glass | case: PVC | Made in Japan

Art.-Nr. Order no.	Vergrößerung Magnification	Linsengröße Size of lens	EUR
60-765	10x	Ø28 mm	34,80
60-766	15x	Ø21 mm	38,50

ESCHENBACH Lupe 2,4fach bis 4,5fach Loupe 2.4x to 4.5x magnification

Aplanatische Lesegläser | verzeichnungsfreie Abbildungsqualität bis zum Rand der Linse |
 ergonomisch geformter Griff | Made in Germany



Aplanatic magnifiers | edge-to-edge distortion-free image | ergonomic handle | Made in Germany



Art.-Nr. Order no.	Vergrößerung Magnification	Dioptrien diopter	Linsengröße size of lens	EUR
43-001	2,4x	5,6	Ø85 mm	63,50
43-002	2,9x	7,4	Ø75 mm	61,50
43-003	3,8x	11,3	Ø60 mm	55,00
43-004	4,5x	14,0	Ø50 mm	57,00

LED-Leuchtlupe 2fach Loupe 2x magnification with LED illumination

mit LED-Beleuchtung | Linse Ø90 mm | auch als Standlupe einsetzbar
 With LED light | lens Ø90 mm | applicable also as stand loupe



Art.-Nr. Order no.	EUR
60-715	14,90

ESCHENBACH LED-Leuchtlupe 4fach bis 12,5fach Loupe 4x to 12.5x magnification with LED illumination

helle, homogene Ausleuchtung durch SMD-LED | Lebensdauer ca. 50.000 Std. | inkl. aufsteck-
 barem Gelb- und Orangefilter | inkl. Batterien | Etui mit Gürtelschleife | Made in Germany
 bright, homogeneous illumination through SMD-LED | lifetime approx. 50,000 h | incl.
 slip-on yellow and orange filter | incl. batteries | case with belt loop | Made in Germany



Art.-Nr. Order no.	Vergrößerung Magnification	Dioptrien diopter	Linsengröße size of lens	EUR
43-033	4x	16	75x50 mm	69,50
43-036	6x	24	Ø58 mm	62,50
43-038	10x	38	Ø35 mm	56,50
43-039	12,5x	50	Ø35 mm	59,50



Lupen, Leuchten, Mikroskope Loupes, lamps, microscopes

ESCHENBACH Scheckkartenlupe 4fach *Loupe 4x magnification in bank card size*

4fache Vergrößerung = 16 Dioptrien | Abmessung 86x54x6 mm | lichtstarke SMD-LED-Beleuchtung | Abschaltautomatik | inkl. Batterien | Made in Germany
4x magnification = 16 diopter | dimensions 86x54x6 mm | bright SMD-LED-illumination | auto power-off | incl. batteries | Made in Germany

ESCHENBACH

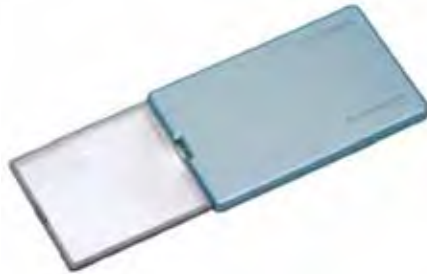

Art.-Nr. Order no.	EUR
43-015	57,50

Einschlaglupe 10fach *Swivelling loupe 10x magnification*



Gehäuse aus Metall
housing from metal

Art.-Nr. Order no.	Vergrößerung Magnification	Linse lens	EUR
60-720	10x	Ø21 mm	5,90

ESCHENBACH Einschlaglupe 6fach bis 12fach *Swivelling loupe 6x to 12x magnification*

Gehäuse mattverchromt mit Öse | Linsenfassung Metall lackiert | Made in Germany
housing satin chrome finished | lens mount metal coated | Made in Germany

ESCHENBACH



43-023

Art.-Nr. Order no.	Vergrößerung Magnification	Linse lens	EUR
43-021	6x		44,50
43-022	8x	Ø21 mm	45,50
43-023	10x		46,50
43-024	12x	Ø15 mm	47,50

Stand-Lupe 2,5fach mit Halteklammern *Stand loupe 2.5x with clips*



2,5fache Vergrößerung | Linse Ø65 mm | Fuß aus Gusseisen | Gesamtgewicht 520 g
2.5x magnification | lens Ø65 mm | base from cast iron | total weight 520 g

Art.-Nr. Order no.	EUR
60-749	22,50

Lupen, Leuchten, Mikroskope

Loupes, lamps, microscopes

ESCHENBACH Brillenlupe 2fach *Eyeglasses loupe 2x magnification*

Arbeitsabstand 400 mm | großes Sehfeld | Dioptrieausgleich ± 3 dpt (rechts/links unabhängig voneinander einstellbar) | leicht anpassbare Bügel | inkl. Hartschaumetui | Made in Germany
Working distance 400 mm | large field of vision | diopter compensation ± 3 dpt (right/left side independently adjustable) | easy customizable earpiece | incl. rigid foam box | Made in Germany

ESCHENBACH



Art.-Nr. Order no.	EUR
43-201	89,50

Messlupe 3,5fach *Measuring loupe 3.5x magnification*



3,5fache Vergrößerung = 10 Dioptrien | Linse vergütet, Ø30 mm | Messbereich 25 mm | Ablesung 1,0 mm | Metall-Gehäuse | Abmessung 55x38x50 mm
3.5x magnification = 10 diopter | lens tempered, Ø30 mm | Range 25 mm | Reading 1,0 mm | case made of steel | dimensions 55x38x50mm

Art.-Nr. Order no.	Beleuchtung illumination	EUR
60-731	ohne without	13,80
60-733	LED	22,50

Messlupe 3,5fach mit Beleuchtung *Measuring loupe 3.5x magnification with illumination*



3,5fache Vergrößerung = 10 Dioptrien | mit integriertem Maßstab und Beleuchtung | Messbereich 20 mm | Auflösung 0,5 mm | inkl. Batterien | Made in Japan
3.5x magnification = 10 diopter | with integrated ruler and illumination | Range 20 mm | Reading 0.5 mm | incl. batteries | Made in Japan

Art.-Nr. Order no.	EUR
60-711	29,50

Messlupe 6fach mit LED-Beleuchtung *Measuring loupe 6x magnification with LED-illumination*

6fache Vergrößerung = 20 Dioptrien | Linse vergütet | Metall-Gehäuse | Sichtfeld 10 mm | Ablesung 0,1 mm | Abmessung Ø37x30 mm
6x magnification = 20 diopter | lens tempered | casing made of metal | Range 10 mm | reading 0.1 mm | dimensions Ø37x30 mm

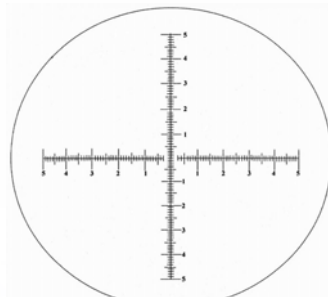

Art.-Nr. Order no.	EUR
60-736	42,50

Lupen, Leuchten, Mikroskope Loupes, lamps, microscopes

ESCHENBACH Messlupe 7fach bis 10fach *Measuring loupe 7x to 10x magnification*



43-052

hochwertige Präzisions-Skalenlupe | Gehäuse Polyamid
glasfaserverstärkt | Scharfstellung über griffigen Fokussiererring |
auswechselbare Präzisions-Messskalen (Glasplatte mit gelasierter Skalierung auf der
Unterseite) | Lieferung der Messlupen mit Standard-Skala 43-055 (Messbereich 20 mm,
Teilung 0,1 mm) und Kunststoffbox mit Platz für weitere Skalen | Lieferung der
Beleuchtungseinrichtung inkl. Batterien | Made in Germany

*High-quality precision scale loupe | housing polyamide glass fiber reinforced | focusing
through slip-proof ring | changeable precision measuring scales (glass discs with laser
scale at bottom side) | loupes are delivered with standard scale 43-055 (Range 20 mm,
Reading 0.1 mm) and box with space for further scales | illumination device
(accessory) incl. batteries | Made in Germany*

ESCHENBACH

Art.-Nr. Order no.	Vergrößerung Magnification	EUR
43-051	7x	79,50
43-052	10x	89,50

Zubehör: Accessories:



43-054

Art.-Nr. Order no.	Zubehör-Artikel accessory article	EUR
43-054	LED-Beleuchtungseinrichtung <i>LED illumination device</i>	66,00
43-055	Mess-Skala Fadenkreuz <i>Measuring scale cross lines</i>	25,80
43-056	Mess-Skala Radien/Winkel/Strichstärke <i>Meas. scale radius/angle/line thickness</i>	25,80
43-057	Mess-Skala Radien/Winkel/mm/inch <i>Measuring scale radius/angle/mm/inch</i>	25,80
43-058	Mess-Skala Linear <i>Measuring scale linear</i>	25,80

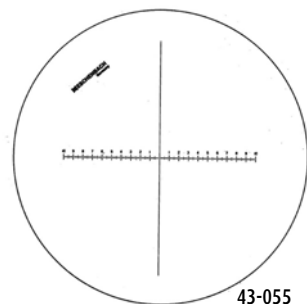

43-055

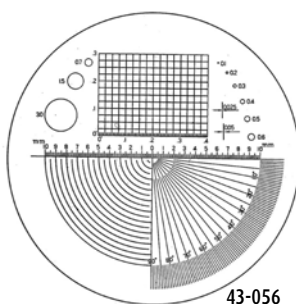

43-056

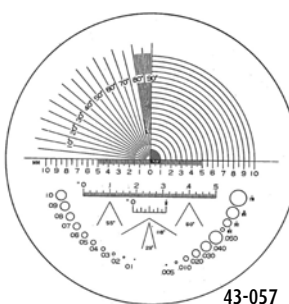

43-057

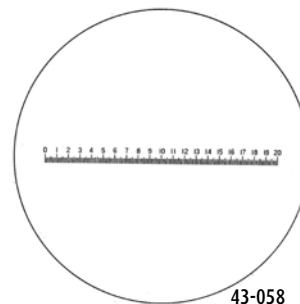

43-058

ESCHENBACH Digitale Messlupe 4fach bis 15fach *Digital measuring loupe 4x to 15x magnification*

im Bereich Fertigung, Qualitätskontrolle oder Reparatur für kontaktfreie, optische Prüfung,
sowohl an der Werkbank als auch unterwegs | 4,3" Touchscreen-Display 480x272 Pixel,
mattiert | Vergrößerung 4x bis 15x | LED-Beleuchtung | Belichtungsautomatik | Speicherfunktion für Fotos auf SD-Karte | Fotoauflösung 1280x720 Pixel |
Messfunktion über Skala/Schablone | Kalibrierfunktion der Skala | selbststehend | PC-Anschluss über USB-Kabel | Livebild am PC inkl. Messsoftware |
Batterielaufzeit ca. 3 h | inkl. Ladegerät, USB-Kabel, Trageschleife, Kurzanleitung, Aufbewahrungskoffer

ESCHENBACH

*within production, quality inspection or repairing for contactless optical check at the workbench as well as on the way | 4.3" touchscreen display 480x272
pixel, matted | magnification 4x to 15x | LED illumination | automatic exposure | saving function for pictures onto SD-card | picture resolution 1280x720
pixel | measuring function through scale/master plate | calibration function for scale | self-standing | connection to PC via USB cable | live picture on PC
incl. measuring software | battery run-time approx. 3 h | incl. recharger, USB cable, suspension band, short instructions, carrying case*



Art.-Nr. Order no.	EUR
43-101	498,00

Anwendungsbeispiele: Examples of use:

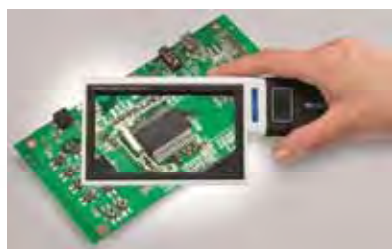

Lupen, Leuchten, Mikroskope

Loupes, lamps, microscopes

Präzisions-Stiftmikroskop 6,25-25fach Precision pen microscope 6.25x to 25x magnification

Linse vergütet | Gehäuse aus Aluminium/Kunststoff | Abmessung ca. Ø12x122 mm
 Lens tempered | casing made of aluminum/plastics | dimensions approx. Ø12x122 mm



Art.-Nr. Order no.	Vergrößerung Magnification	Dioptrie Diopter	Messlänge Range	Ableseung Reading	EUR
60-752	6,25x	25	4,0 mm	0,05 mm	34,50
60-754	12,5x	50	2,0 mm	0,02 mm	41,50
60-756	25x	100	1,0 mm	0,01 mm	57,50

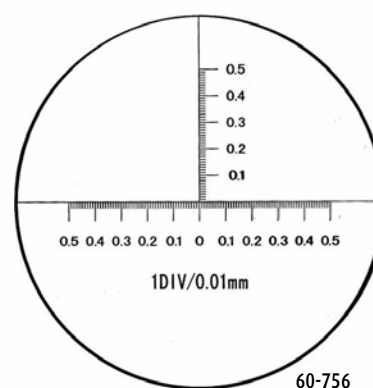
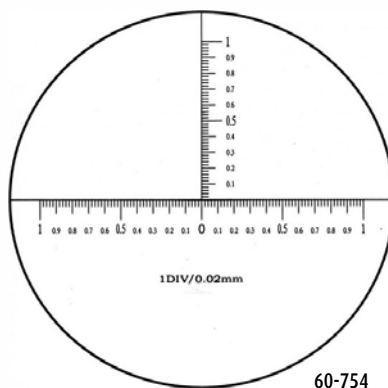
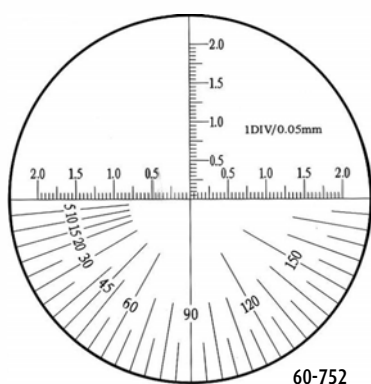

Präzisions-Stabmikroskop 10-50fach Precision rod microscope 10x to 50x magnification

Linse vergütet | Kunststoffgehäuse | LED-Beleuchtung | mit/ohne Mess-Strichplatte | Abmessung ca. 138x50x23 mm
 Lens tempered | casing made of plastics | LED light | with/without scale | dimensions approx. 138x50x23 mm

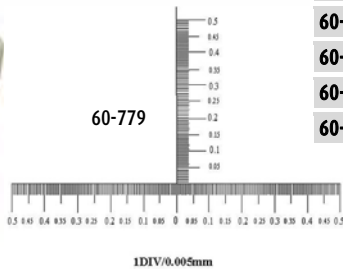

Art.-Nr. Order no.	Vergrößerung Magnification	Dioptrie Diopter	Sichtfeld Sight	Messlänge Range	Ableseung Reading	EUR
60-771				-	-	24,80
60-772	10x	40	4,4 mm	4,0 mm	0,05 mm	39,80
60-773					0,02 mm	46,00
60-775	25x	100	1,9 mm	-	-	49,50
60-776				1,6 mm	0,01 mm	64,50
60-778	50x	200	1,1 mm	-	-	92,50
60-779				1,0 mm	0,005 mm	105,00

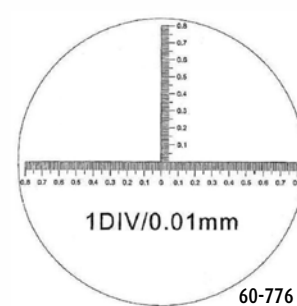
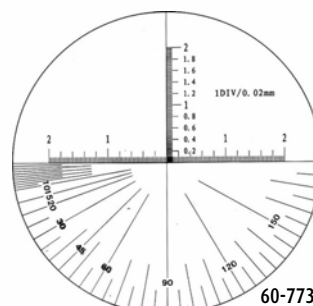
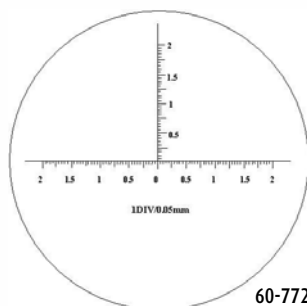

Lupen, Leuchten, Mikroskope Loupes, lamps, microscopes

LED-Leuchte LED lamp



mit rundem Magnetfuß | flexibler Halter | Länge ca. 220 mm | inkl. Batterien
with magnetic base | flexible support | Length approx. 220 mm | incl. batteries

Art.-Nr. Order no.	EUR
60-761	25,80

LED-Arbeitsleuchte dimmbar LED working lamp dimmable



Arbeitsleuchte mit flexiblem Gelenkarm (Armlänge 400 + 400 mm) | 117 LEDs (24 W) |
Lichtstärke dimmbar | Lichttemperatur 6000-7000 K | Lichtmenge 1200 Lm | Tischklemme |
Lebensdauer ca. 20.000 h | 230 V / 50 Hz

Working lamp with adjustable arms (arm length 400 + 400 mm) | 117 LEDs (24 W) | light
intensity dimmable | Luminous colour 6000-7000 K | Light quantity 1200 Lm | Desk
clamping | Lifetime approx. 20,000 h | 230 V / 50 Hz

Art.-Nr. Order no.	EUR
60-709	89,00

Arbeitslupe 2,25fach Magnifying lamp 2.25x

2,25fache Vergrößerung = 5 Dioptrien | LED-Beleuchtung (60 LEDs, 600 Lux) | Linse Ø127 mm | Armlänge ca. 600 mm | 230 V/50 Hz/3,5 W
2.25x magnification = 5 diopter | LED light (60 LEDs, 600 Lux) | lens Ø127 mm | Length of arm approx. 600 mm | 230 V/50 Hz/3.5 W



Art.-Nr. Order no.	Befestigungsart Clamping	EUR
60-706	Tischklemme Desk clamping	73,50
60-707	Standfuß Stand base	96,50

ESCHENBACH Arbeitslupe 2,5fach mit Schwanenhalsstativ Magnifying lamp 2.5x with swan neck stand



ESCHENBACH

2,5fache Vergrößerung = 6 Dioptrien | Linse Ø76 mm | LED-Beleuchtung | schwenkbarer
Lupenkopf | flexibles Schwanenhalsstativ 350 mm | 230 V / 50 Hz | Tischklemme | Made in
Germany

2.5x magnification = 6 diopter | lens Ø76 mm | LED illumination | rotatable lamp head |
flexible swan neck stand 350 mm | 230 V / 50 Hz | Desk clamping | Made in Germany

Art.-Nr. Order no.	EUR
43-441	358,00

ESCHENBACH Arbeitslupe 2,5fach Magnifying lamp 2.5x

Linsengröße Ø132 mm | Beleuchtungsstärke mehrstufig regelbar (max. 6000 lx) | randscharfe und verzerrungsfreie Abbildung | 6 Gelenke | Aktionsradius 90 cm | Linsenabdeckung klapp- und abnehmbar | 100-240 V / 50-60 Hz | Tischklemme für Arbeitsplatten 18-74 mm | Made in Germany

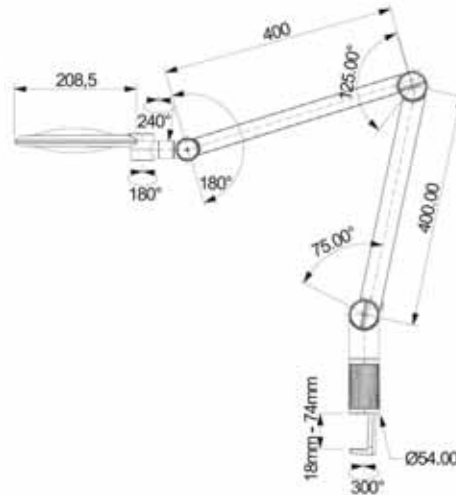

Size of lens Ø132 mm | Illumination multi-stage adjustable (max. 6000 lx) | high edge definition and distortion-free picture | 6 joints | operating range 90 cm | lens cover foldaway and removable | 100-240 V / 50-60 Hz | Desk clamping for workplates 18-74 mm | Made in Germany

Art.-Nr. Order no.	EUR
43-411	578,00

Foto-Video-Endoskop Video inspection endoscope

für schnelle, visuelle Prüfungen an schwer zugänglichen Stellen | 3,5"-Farbmonitor, Auflösung 320x240, digitaler Zoom | Kameraauflösung 640x480 | Sonde wasserdicht nach IP67 | Betrachtungswinkel 60° | dimmbare LED-Beleuchtung | Spannungsversorgung über 9V-Batterie | inkl. Zubehör-Aufsätze „Magnet“, „90°-Spiegel“ und „Haken“ (nur bei Sonde Ø9 mm) | Set im Koffer



for quick, visual inspection of badly accessible locations | 3.5" color display, resolution 320x240, digital zoom | camera resolution 640x480 | probe head water-resistant according to IP67 | viewable angle 60° | dimmable LED illumination | power supply through 9V-battery | incl. top parts "magnet", "90°-mirror" and "hook" (only with probe Ø9 mm) | set in carrying case

Art.-Nr. Order no.	Kamera-Sonde Probe head	EUR
34-002	Ø9,0x1000 mm	199,00
34-003	Ø5,5x1000 mm	279,00
34-006	Ø9,0x3000 mm	244,00
34-007	Ø5,5x3000 mm	299,00

Foto-Video-Endoskop mit großem abnehmbarem Monitor Video inspection endoscope with large removable display

für schnelle, visuelle Prüfungen an schwer zugänglichen Stellen | abnehmbarer 5"-Farbmonitor (max. Reichweite ca. 10 m), Auflösung 800x480, digitaler Zoom | interner Speicher 128 MB | Einschub für SD-Speicherkarte zum Speichern von Fotos und Videos | Sonde wasserdicht nach IP67 | Betrachtungswinkel 60° | dimmbare LED-Beleuchtung | Spannungsversorgung über wiederaufladbaren Lithium-Akku, inkl. Netzteil | inkl. Zubehör-Aufsätze „Schutzkappe“, „Magnet“, „90°-Spiegel“ und „Haken“ | Set im Koffer



for quick, visual inspection of badly accessible locations | removable 5" color display (max. operating distance approx. 10 m), resolution 800x480, digital zoom | internal memory 128 MB | slot for SD memory card to save pictures and videos | probe head water-resistant according to IP67 | viewable angle 60° | dimmable LED illumination | power supply through rechargeable lithium battery, incl. power supply | incl. top parts "protecting cap", "magnet", "90°-mirror" and "hook" | set in carrying case

enthaltene Zubehör included accessories:



Art.-Nr. Order no.	Kamera-Sonde Probe head	EUR
34-022	Ø9,0x1000 mm	415,00
34-024	Ø9,0x3000 mm	427,00

Stereo-Zoom-Mikroskop SM20 *Stereo zoom microscope SM20*

Stereo-Mikroskop mit Zoomobjektiv | Vergrößerung 10-40x (stufenloser Zoom) | Arbeitsabstand 80 mm | max. Teilehöhe 100 mm | Beleuchtung: LED-Auf- und Durchlicht

Stereo microscope with zoom lens | Magnification 10-40x (continuously adjustable zoom) | working distance 80 mm | max. height of parts 100 mm | illumination: LED top and bottom light



60-012

Art.-Nr. Order no.	EUR
60-012	329,00



60-077

Zubehör:
Accessories:

Art.-Nr. Order no.	Zubehör accessories	Zoom	Arbeitsabstand working distance	EUR
60-016	Okular (Paar) <i>ocular (pair)</i> 20x	20-80x	80 mm	47,50
60-018	Vorsatzlinse <i>lens</i> 1,5x	15-60x	53 mm	38,00
60-019	Vorsatzlinse <i>lens</i> 0,5x	5-20x	160 mm	38,00
60-077	Positioniertisch 70x50 mm <i>positioning table 70x50 mm</i>			174,00
60-090	Adapter für Ringlicht Ø60 mm <i>adaptor for ring light Ø60 mm</i>			5,70
60-521	LED-Ringlicht RL4 (Ø60 mm) <i>LED ring light RL4 (Ø60 mm)</i>			309,00



60-521

Ersatzteile:
Spare parts:

Art.-Nr. Order no.	Bezeichnung description	EUR
60-013*	Lampe Auflicht <i>top light</i>	3,50
60-014*	Lampe Durchlicht <i>bottom light</i>	3,50
60-015	Augenmuschel-Paar <i>eyecups (pair)</i>	4,50

*nur für 60-011 (SM20 mit Halogen-Beleuchtung, bis 2020)
only for 60-011 (SM20 with halogen illumination, till 2020)

DINO-LITE Okular-Kamera *Eyepiece camera*

macht aus herkömmlichen Mikroskopen ein Digital-Mikroskop | zum Tausch von Okularen mit Ø23/Ø30/Ø30,5 mm (geeignet für unsere Stereo-Mikroskope SM20/SLX/SZM/SZN) | Auflösung 1,3 Megapixel | Mess- und Kalibrierfunktion über die Software | Aluminiumgehäuse | Anschluss USB 2.0 | inkl. Software „DinoCapture“ (Windows 10)

to update your conventional microscope into a digital microscope | replaces eyepieces with Ø23/Ø30/Ø30.5 mm (suitable for our stereo microscopes SM20/SLX/SZM/SZN) | resolution 1.3 megapixel | measuring and calibration function via software | aluminium housing | connection USB 2.0 | incl. software "DinoCapture" (Windows 10)

Dino-Lite
Digital Microscope
The Industry Standard



Art.-Nr. Order no.	EUR
49-951	349,00

OPTIKA Stereo-Mikroskop SLX Stereo microscope SLX

Stereo-Mikroskop mit hochwertiger Optik | Arbeitsabstand 100 mm | max. Teilehöhe 120 mm | Netzbetrieb oder Akkubetrieb möglich (Lieferung inkl. Netzteil und Akkus) | binokular (Standard) oder trinokular (mit C-Mount-Adapter zum Anschließen einer 1/8"-CCD-Kamera)

Stereo microscope with high-grade optical characteristics | working distance 100 mm | max. height of parts 120 mm | operation by mains or battery (mains adapter and rechargeable batteries included) | binocular (standard) or trinocular (with C-mount-adapter to connect with a 1/8"-CCD-camera)

OPTIKA®

Art.-Nr. Order no.	Typ type	Kopf head	Vergrößerung magnification	Beleuchtung illumination	Fuß base	EUR
60-120	SLX-1	binokular	20x / 40x	LED Auf- und Durchlicht LED top and bottom light	Standard	275,00
60-121	SLX-2					395,00
60-122	SLX-3	trinokular	stufenloser Zoom continuously adjustable zoom 7x - 45x	ohne without		559,00
60-126	SLX-4	binokular			Guss-Tischfuß mit Säule (420 mm) und Querarm (430 mm) cast iron base with overhanging stand (450 mm)	532,00
60-127	SLX-5	trinokular				708,00



60-121



60-122



60-120



60-126

Zubehör:
Accessories:

Art.-Nr. Order no.	geeignet für suitable for					Zubehör accessories	Zoom	Arbeitsabstand working distance	EUR
	SLX-1	SLX-2	SLX-3	SLX-4	SLX-5				
60-031	X	X	X	X	X	Okular (Paar) ocular (pair) 20x	14-90x*	100 mm	88,50
60-033	X	X	X	X	X	Mess-Okular measuring ocular 10x	7-45x**	100 mm	88,50
60-131		X	X			Vorsatzlinse lens 0,5x	3,5-22,5x	165 mm	96,00
60-132		X	X			Vorsatzlinse lens 1,5x	10,5-67,5x	45 mm	102,00
60-543			X		X	1/8"-CCD-Kamera USB 2.0 1280x1024 inkl. Videobild-Software 1/8"-CCD-camera USB 2.0 1280x1024 incl. video software			395,00
02-1009			X		X	USB-Anschlusskabel für Kamera USB cable for camera			5,90
60-521		X	X	X	X	LED-Ringlicht RL4 (Ø60 mm) LED ring light RL4 (Ø60 mm)			309,00

*Zoom bei SLX-1: 40x/80x

** Zoom bei SLX-1: 20x/40x

* Zoom with SLX-1: 40x/80x

** Zoom with SLX-1: 20x/40x

Ersatzteile:
Spare parts:

Art.-Nr. Order no.	Bezeichnung description	EUR
60-065	Augenmuschel-Paar eyecups (pair)	4,50

Lupen, Leuchten, Mikroskope

Loupes, lamps, microscopes

NIKON Stereo-Zoom-Mikroskop SMZ445/460 Stereo zoom microscope SMZ445/460

Modulares Stereo-Mikroskop mit stufenlosem Zoomobjektiv und exzellenter Optik | Vergrößerung 3,5-70x (abhängig von gewählter Variante^{***}) | Arbeitsabstand 100 mm | verstellbarer Pupillenabstand 54-75 mm | Dioptrien-Kompensation an beiden Okularen | verschiedene Okulare, Stative, Beleuchtungen wählbar

Modular stereo microscope with continuously adjustable zoom lens and high optical performance | Magnification 3.5-70x (dependent of chosen variant^{***}) | working distance 100 mm | adjustable interpupillary distance 54-75 mm | dioptic compensation on both eyepiece tubes | different eyepieces, stands, illuminations selectable



Mikroskop-Zoom-Köpfe* Microscope zoom heads*

Art.-Nr. Order no.	Typ type	Tubus-Winkel Eyepiece inclination	Zoom-Bereich Zooming range	EUR
75-201*	SMZ445	45°	0,8-3,5x	449,00
75-202*	SMZ460	60°	0,7-3x	469,00

*ohne Okulare without eyepieces

Okulare (Paar): Eyepieces (pair):

Art.-Nr. Order no.	Vergrößerung Magnification	EUR
75-211	10x	84,50
75-212	15x	116,00
75-213	20x	116,00

Stative: Stands:

Art.-Nr. Order no.	Typ Type	EUR
75-221**	Stativ mit einstellbarem Fokussiertrieb (Höhenverstellung) Focusing stand (height adjustment)	329,00
75-222	LED-Auflicht-/Durchlichtstativ inkl. Netzkabel 230 V Stand with LED top and bottom illumination incl. power cable 230 V	935,00

**ohne Beleuchtung without illumination

Vorsatzlinsen (optional): Auxiliary objective lenses (optional):

Art.-Nr. Order no.	Vergrößerung Magnification	Arbeitsabstand Working distance	EUR
75-231	0,7x	127,5 mm	249,00
75-232	0,5x	181 mm	99,00



***Die Gesamtvergrößerung ergibt sich aus der Multiplikation der Vergrößerungen von Mikroskop-Kopf, Okular und (optional) Vorsatzlinse!

***The total magnification is calculated by multiplication of magnifications of microscope head, eyepiece and (optional) auxiliary objective lens!



75-201 mit 75-211 und 75-221
75-201 with 75-211 and 75-221

Zubehör: Accessories:



75-241



75-251



75-253

Art.-Nr. Order no.	Beschreibung Description	EUR
75-241	LED-Auflicht für 75-221 (inkl. Regler und Netzkabel 230 V) LED top light for 75-221 (incl. control unit and power cable 230 V)	435,00
75-251	XY-Positioniertisch (Verfahrweg 150x65 mm) XY stage (stroke 150x65 mm)	1795,00
75-253	Kippbarer Tisch (30°) Tilting stage (30°)	555,00

Weitere Modelle und Zubehör auf Anfrage!
Further models and accessories on request!

Lupen, Leuchten, Mikroskope

Loupes, lamps, microscopes

DINO-LITE USB-Digital-Mikroskop USB digital microscope

preiswertes USB-Mikroskop für einfache Anwendungen mit umfangreicher Software | Vergrößerung 10x-70x/200x | Auflösung 1,3 Megapixel | Zoomobjektiv | Mess- und Kalibrierfunktion | Kunststoffgehäuse | über Software ein-/ausschaltbare LED-Beleuchtung | Anschluss USB 2.0



Dino-Lite
Digital Microscope
The Industry Standard

good value USB-microscope for simple applications with comprehensive software | magnification 10x-70x/200x | resolution 1.3 megapixel | zoom lens | measuring and calibration function | housing made of plastics | switchable LED illumination via software | connection USB 2.0

Art.-Nr. Order no.	EUR
49-701	274,00

DINO-LITE USB-Digital-Mikroskop „EDGE“ USB digital microscope „EDGE“

digitales USB-Mikroskop mit überlegener Bildqualität („EDGE-Ausführung“), umfangreichem Angebot an Zusatzfunktionen und leistungsstarker Software – der Industriestandard für portable Digital-Mikroskopie | Vergrößerung 10x bis 220x | Auflösung 1,3 bis 5 Megapixel | Zoomobjektiv | Mess- und Kalibrierfunktion | mit oder ohne Polarisationsfilter | Aluminium- oder Kunststoffgehäuse | optional: automatische Vergrößerungsauslesung (AMR), erweiterte Tiefenschärfe (EDOF) | über Software dimmbare LED-Beleuchtung | Anschluss USB 2.0

Dino-Lite
Digital Microscope
The Industry Standard

digital USB-microscope with superior image quality (“EDGE-model”), wide range of additional functions and high-performance software - the industrial standard for portable digital microscopy | magnification 10x to 220x | resolution 1.3 to 5 megapixel | zoom lens | measuring and calibration function | with or without polarizing filter | housing made of aluminum or plastics | optional: automatic magnification readout (AMR), extended depth of field (EDOF) | dimmable LED illumination via software | connection USB 2.0



ohne without EDOF**

mit with EDOF**



ohne without

mit with

Polarisationsfilter polarizing filter



Art.-Nr. Order no.	Auflösung Resolution	Vergrößerung Magnification	Polarisation Polarizing	Gehäuse housing	AMR*	EDOF**	EUR		
49-711	1,3 Megapixel	20x bis to 220x		Kunststoff plastics			459,00		
49-712			X				539,00		
49-713		10x bis to 55x			X			499,00	
49-714			X				559,00		
49-715		20x bis to 220x				X		499,00	
49-716			X					579,00	
49-717								X	639,00
49-718			X						709,00
49-721	5 Megapixel	20x bis to 220x		Metall metal			799,00		
49-722			X		X		859,00		
49-723						X		999,00	

*AMR automatische Vergrößerungsauslesung (die eingestellte Zoom-Vergrößerung wird automatisch an die Software übertragen)
automatic magnification readout (the adjusted zoom-magnification is automatically transferred to the software)

**EDOF erweiterte Tiefenschärfe (die Software setzt aus mehreren Bildern unterschiedlicher Fokussierung ein neues Bild mit erweiterter Tiefenschärfe zusammen)
extended depth of field (the software takes several images with different focusing and assembles a new image with extended depth of field)

alle DINO-LITE Mikroskope inkl. umfangreicher mehrsprachiger Software „DinoCapture“ zum Betrachten, Messen und Dokumentieren

all DINO-LITE microscopes incl. comprehensive multi-lingual software “DinoCapture” for observing, measuring and documenting

DINO-LITE USB-Digital-Mikroskop „EDGE“ mit großer Vergrößerung *USB digital microscope „EDGE“ high magnification*

digitales USB-Mikroskop mit überlegener Bildqualität („EDGE-Ausführung“), umfangreichem Angebot an Zusatzfunktionen und leistungsstarker Software – der Industriestandard für portable Digital-Mikroskopie | Vergrößerung 400x bis 900x | Auflösung 1,3 bis 5 Megapixel | Zoomobjektiv | Mess- und Kalibrierfunktion | mit oder ohne Polarisationsfilter | Aluminium- oder Kunststoffgehäuse | automatische Vergrößerungsauslesung (AMR) | über Software dimmbare LED-Beleuchtung | Anschluss USB 2.0

Dino-Lite
Digital Microscope
The Industry Standard

digital USB-microscope with superior image quality („EDGE-model“), wide range of additional functions and high-performance software - the industrial standard for portable digital microscopy | magnification 400x to 900x | resolution 1.3 to 5 megapixel | zoom lens | measuring and calibration function | with or without polarizing filter | housing made of aluminum or plastics | automatic magnification readout (AMR) | dimmable LED illumination via software | connection USB 2.0



49-753

Art.-Nr. Order no.	Auflösung Resolution	Vergrößerung Magnification	Polarisation Polarizing	Gehäuse housing	EUR
49-751	1,3 Megapixel	400x bis to 470x	X	Kunststoff plastics	599,00
49-752		500x bis to 550x			539,00
49-753		700x bis to 900x			639,00
49-761	5 Megapixel	500x bis to 550x		Metall metal	929,00
49-762		700x bis to 900x			999,00

DINO-LITE Stative für USB-Digital-Mikroskope *Stands for USB digital microscopes*

passend für alle DINO-LITE USB-Digital-Mikroskope | verschiedene Modelle erhältlich | Lieferung ohne Mikroskop
suitable for all DINO-LITE USB digital microscopes | different models available | without microscope

Dino-Lite
Digital Microscope
The Industry Standard



49-911



49-913



49-901



49-916

Art.-Nr. Order no.	Typ type	EUR
49-911	Stativ mit Höhenverstellung <i>stand with height adjustment</i>	99,00
49-913	Stativ mit Höhenverstellung und verschiebbarem Querarm <i>stand with height adjustment and adjustable transverse arm</i>	189,00
49-901	Stativ mit Schnellspannfunktion und Präzisions-Feineinstellung <i>stand with quick clamp function and precision fine adjustment</i>	259,00
49-916	Flexibles Schwanenhals-Stativ mit Tischklemme (Länge ca. 60 cm) <i>flexible swan neck stand with desk clamping (length approx. 60 cm)</i>	124,00

Lupen, Leuchten, Mikroskope Loupes, lamps, microscopes

Digital-Mikroskop VZS *Digital microscope VZS*

zum ermüdungsfreien **Betrachten** von Teilen jeglicher Art | Vergrößerung 10-80x (stufenloses Zoom-Objektiv) | Sehfeld in X-Richtung: 17-2 mm | Arbeitsabstand 110 mm | 8"-LCD-Monitor | Fadenkreuz einblendbar | LED-Auf-/Durchlicht
for fatigue-proof observation of all varying products | magnification 10-80x (stepless zoom objective) | camera coverage X: 17-2 mm | working distance 110 mm | 8"-LCD-display | overlaying of crosslines possible | LED top/bottom light



Art.-Nr. Order no.	EUR
60-926	895,00

Zubehör *accessories:*

Art.-Nr. Order no.	Bezeichnung description	EUR
60-520	LED-Ringlicht RL2 <i>LED ring light RL2</i>	273,00
60-077	Positioniertisch 70x50 mm <i>positioning table 70x50 mm</i>	174,00

Digital-Mikroskop mit Tablet-Computer VZS-Tab *Digital microscope with tablet computer VZS-Tab*

zum **Betrachten und Dokumentieren** von Teilen jeglicher Art | Vergrößerung 10-80x (stufenloses Zoom-Objektiv) | Sehfeld in X-Richtung: 17-2 mm | Arbeitsabstand 110 mm | Tablet-PC Windows 10 FullHD mit USB-Schnittstelle, WLAN und Videobild-Software | Software-Funktionen: Einblenden von Fadenkreuz, Linien, Kreisen, Text, Datum-/ Zeitstempel; Bilder speichern, Videosequenzen aufnehmen; verschiedene Bildparameter verstellbar, mehrsprachig | LED-Auf-/Durchlicht
for observation and documentation of all varying products | magnification 10-80x (stepless zoom objective) | camera coverage X: 17-2 mm | working distance 110 mm | Tablet-PC Windows 10 FullHD with USB-interface, Wi-Fi and video software | software features: overlaying cross lines, lines, circles, text, date and time; saving pictures, grabbing videos; adjustable picture parameters, multilingual | LED top/bottom light



Art.-Nr. Order no.	EUR
60-928	1495,00

Zubehör *accessories:*

Art.-Nr. Order no.	Bezeichnung description	EUR
60-520	LED-Ringlicht RL2 <i>LED ring light RL2</i>	273,00
60-077	Positioniertisch 70x50 mm <i>positioning table 70x50 mm</i>	174,00

Video-Zoom-Messmikroskop CZM-Basic *Video zoom measuring microscope CZM-Basic*

zum **Messen, Betrachten und Dokumentieren** | Komplett-System inkl. Messrechner (Desktop-PC Windows 10 mit 24"-FullHD-LED-Monitor) und Software „WinGeo2dVideoUSB“ | Messtisch mit inkrementalem Messsystem, Auflösung 0,001 mm | Vergrößerung: Sehfeld in X-Richtung 12-1,8 mm (Zoom min/max), entspricht einer Vergrößerung von 29x-185x auf dem Monitor (bei Verwendung des 24"-FullHD-Monitors) | C-Mount-1/3"-USB2.0-Kamera 1280x1024 | max. Werkstückhöhe 115 mm | max. Tischbelastung 10 kg | LED-Ringlicht und LED-Durchlicht mit Lichtsteuerung | Grundkörper aus Hartgestein | Made in Germany | inklusive Werkskalibrierzeugnis rückführbar auf DKD-Normal

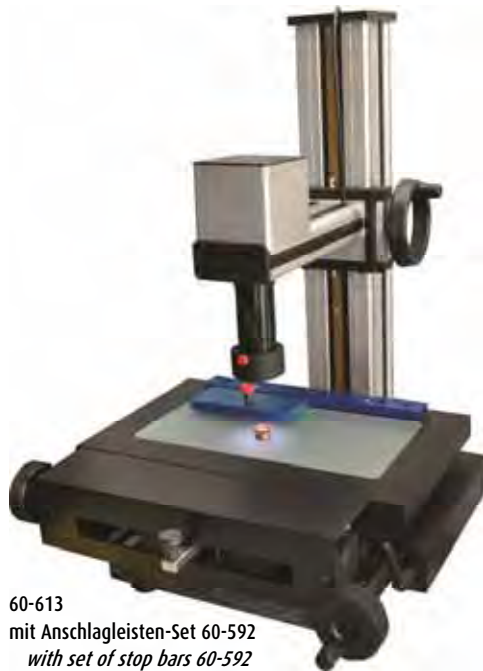

60-613
mit Anschlagleisten-Set 60-592
with set of stop bars 60-592

for measuring, observing and documenting | complete system incl. measuring computer (Desktop-PC Windows 10 + 24"-FullHD-LED-monitor) and software "WinGeo2dVideoUSB" | measuring table with incremental measuring system, reading 0.001 mm | Magnification: camera coverage X: 12-1.8 mm (zoom min/max), corresponding to a magnification of 29x-185x on the monitor (when using a 24"-FullHD-monitor) | C-Mount-1/3"-USB2.0-camera 1280x1024 | max. height of workpiece 115 mm | max. table load 10 kg | LED ring light and bottom light with light control | base made of hard stone | Made in Germany | incl. proprietary calibration certificate traceable to DKD standard

Art.-Nr. Order no.	Messbereich Range	Tisch-Schnell- verstellung table quick adjustment	EUR
60-612	100x100 mm	nein <i>no</i>	9390,00
60-613	200x100 mm	ja <i>yes</i>	11390,00
60-614	300x200 mm		12490,00

im Lieferumfang enthalten *included in shipment:*



Lichtsteuerung für LED-Auflicht/-Durchlicht
light control for LED top and bottom light



Messrechner mit 24"-FullHD-Monitor
measuring computer with 24"-FullHD-monitor

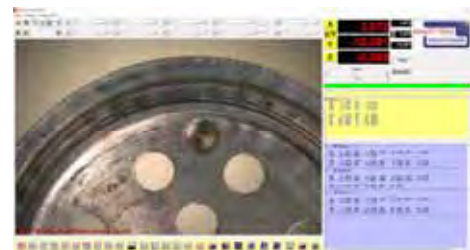

Software „WinGeo2dVideoUSB“
software "WinGeo2dVideoUSB"

Zubehör *accessories:*

Art.-Nr. Order no.	Beschreibung description	EUR
60-607	Vorsatzlinse <i>lens</i> 0,5x	107,00
60-482	Verlängerung Z-Säule (+200 mm) <i>extension of Z-pillar (+200 mm)</i>	205,00
60-592	Anschlagleisten-Set <i>set of stop bars</i>	86,00

Weiteres Zubehör finden Sie auf den Folgeseiten!
Further accessories on the following pages!

Video-Zoom-Messmikroskop CZM Video zoom measuring microscope CZM

zum **Messen, Betrachten und Dokumentieren** | Komplettsystem inkl. Messrechner (Desktop-PC Windows 10 mit 24"-FullHD-LED-Monitor), Software „WinGeo2dVideoUSB“ und hochwertiger Optik in modularer Bauweise mit vielen Änderungs-/Erweiterungsmöglichkeiten | Messtisch mit inkrementalem Messsystem, Auflösung 0,001 mm | Vergrößerung: 4x bis 665x (abhängig von Variante und Zusatzausstattung) | C-Mount-1/2"-USB3.0-Kamera 1280x1024 | Arbeitsabstand 80 mm | LED-Ringlicht und LED-Durchlicht mit Lichtsteuerung | Grundkörper aus Hartgestein | Fußtaster (ab Messbereich 200x100 mm) | Made in Germany | inklusive Werkskalibrierzeugnis rückführbar auf DKD-Normal



60-446
mit Anschlagleisten-Set 60-592
with set of stop bars 60-592

for measuring, observing and documenting | complete system incl. measuring computer (Desktop-PC Windows 10 with 24"-FullHD-LED-monitor), software "WinGeo2dVideoUSB" and high-grade optical characteristics, modular construction with many changing and upgrading possibilities | measuring table with incremental measuring system, reading 0.001 mm | Magnification: 4x-665x (dependent on variant and accessories) | C-Mount-1/2"-USB3.0-camera 1280x1024 | working distance 80 mm | LED ring light and bottom light with light control | base made of hard stone | foot switch (from range 200x100 mm) | Made in Germany | incl. proprietary calibration certificate traceable to DKD standard

Art.-Nr. Order no.	Messbereich Range	max. Werkstückhöhe max. height of workpiece	Tisch-Schnellverstellung table quick adjustment	max. Tischbelastung max. table load	C-Mount-Adapter	Vergrößerung auf Monitor Magnification on monitor	Sehfeld X (mm) camera coverage (mm)	EUR
60-431	100x100 mm	180 mm	nein no	10 kg	1,0	41x-205x	8,4-1,7	12890,00
60-435					0,4	16x-80x	21,5-4,2	13160,00
60-442	200x100 mm	180 mm	ja yes	10 kg	1,0	41x-205x	8,4-1,7	14990,00
60-446					0,4	16x-80x	21,5-4,2	15260,00
60-443	300x200 mm	180 mm	ja yes	10 kg	1,0	41x-205x	8,4-1,7	16290,00
60-447					0,4	16x-80x	21,5-4,2	16560,00
60-448*	500x300 mm	380 mm		10 kg	0,4	16x-80x	21,5-4,2	22490,00

*inkl. Zusatztrieb 60-496 + verlängerte Z-Säule incl. additional pinion 60-496 + long Z-pillar

im Lieferumfang enthalten included in shipment:



Lichtsteuerung für LED-Auflicht/-Durchlicht
light control for LED top and bottom light



Messrechner mit 24"-FullHD-Monitor
measuring computer with 24"-FullHD-monitor

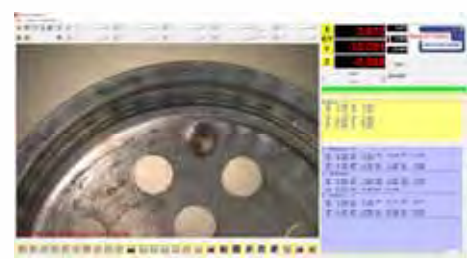

Software „WinGeo2dVideoUSB“
software "WinGeo2dVideoUSB"

Zubehör accessories:

Art.-Nr. Order no.	Beschreibung description	EUR
60-471	Vorsatzlinse lens 2x (Arbeitsabstand working distance 40 mm)	158,00
60-472	Vorsatzlinse lens 0,5x (Arbeitsabstand working distance 160 mm)	153,00
60-473	Vorsatzlinse lens 0,25x (Arbeitsabstand working distance 320 mm)	168,00
60-465	C-Mount-Adapter 0,4x	425,00
60-466	C-Mount-Adapter 1,0x	142,00
60-467	C-Mount-Adapter 1,6x	415,00
60-482	Verlängerung Z-Säule (+200 mm) extension Z-pillar (+200 mm)	205,00
60-496	Zusatztrieb additional pinion	498,00
60-491	Feintrieb fine pinion	928,00
60-486	Maßstab für Z-Achse (Auflösung 0,005 mm) scale for Z-axis (Reading 0.005 mm)	749,00
60-487	Maßstab für Z-Achse für verlängerte Z-Säule (Aufl. 0,005 mm) scale for Z-axis for extended Z-pillar (Reading 0.005 mm)	859,00

Detaillierte Beschreibungen und weiteres Zubehör finden Sie auf den Folgeseiten!

Detailed descriptions and further accessories can be found on the following pages!

Lupen, Leuchten, Mikroskope *Loupes, lamps, microscopes*

NIKON Messlösungen *Measuring solutions*

NIKON bietet eine riesige Auswahl von Messgeräten in exzellenter Qualität auch für komplexe Messaufgaben | Industriemikroskope, Profilprojektoren, Messmikroskope, Videomesssysteme, Messsoftware, Rasterelektronenmikroskope, Röntgen- und CT-Inspektionssysteme u. a.

Fragen Sie uns nach der passenden Lösung für Ihre Anwendung!

NIKON is offering a huge variety of measuring devices with excellent quality also for complex measuring tasks | Industrial microscopes, profile projectors, measuring microscopes, video measuring systems, measuring software, scanning electron microscopes, X-ray and CT inspection systems, etc. Please ask for a suitable solution for your application!



Vorsatzlinse *Ancillary lens*



für Messmikroskope der CZM-Baureihe (nicht geeignet für CZM-Basic) | verändert die Vergrößerung um den jeweiligen Faktor
for measuring microscopes of the CZM series (not suitable for CZM-Basic) | changes the magnification with the given factor

Art.-Nr. Order no.	Vergrößerung Magnification	Arbeitsabstand working distance	EUR
60-471	2x	40 mm	158,00
60-472	0,5x	160 mm	153,00
60-473	0,25x	320 mm	168,00

C-Mount-Adapter *C-Mount-Adaptor*



60-466



60-465

für Messmikroskope der CZM-Baureihe (nicht geeignet für CZM-Basic) | verändert die Vergrößerung um den jeweiligen Faktor
for measuring microscopes of the CZM series (not suitable for CZM-Basic) | changes the magnification with the given factor

Art.-Nr. Order no.	Vergrößerung Magnification	EUR
60-465	0,4x	425,00
60-466	1,0x	142,00
60-467	1,6x	415,00

Zusatztrieb *Additional pinion*



für Messmikroskope der CZM-Baureihe (nicht geeignet für CZM-Basic) | zum einfacheren Einstellen des Fokus |
Verfahrweg 50 mm
*for measuring microscopes of the CZM series (not suitable for CZM-Basic) | for simply adjusting the focus |
travelling distance 50 mm*

Art.-Nr. Order no.	EUR
60-496	498,00

Feintrieb *Fine pinion*



für Messmikroskope der CZM-Baureihe (nicht geeignet für CZM-Basic) | zum einfacheren und präziseren Einstellen
des Fokus | Auflösung 0,002 mm | Verfahrweg 25 mm (über Grob- und Feintrieb)
*for measuring microscopes of the CZM series (not suitable for CZM-Basic) | for simple and precise focus
adjustment | Resolution 0.002 mm | travelling distance 25 mm (via both pinions)*

Art.-Nr. Order no.	EUR
60-491	928,00

Maßstab für Z-Achse *Scale for Z-axis*

für Messmikroskope der CZM-Baureihe (nicht geeignet für CZM-Basic) | zum Messen in Z-Richtung über die Fokussierung | Auflösung 0,005 mm
for measuring microscopes of the CZM series (not suitable for CZM-Basic) | for measuring Z-axis via focus | resolution 0.005 mm



Art.-Nr. Order no.	Messbereich Range	EUR
60-486	300 mm (für Standard-Ausführung <i>standard</i>)	749,00
60-487	500 mm (für verlängerte Z-Säule <i>for extended Z-pillar</i>)	859,00

Lupen, Leuchten, Mikroskope Loupes, lamps, microscopes

Anschlagleisten-Set *Set of stop bars*

für Messmikroskope der CZM-/CZM-Basic-Baureihe und die kompakten Profilprojektoren VP160-LCD und VP-200Tab | zum schnellen rechtwinkligen Ausrichten von Teilen auf dem Messtisch | Aluminium blau eloxiert | inkl. Befestigungsmaterial
for measuring microscopes of the CZM/CZM-Basic series and the compact profile projectors VP-160LCD and VP-200Tab | for fast rectangular positioning of parts on the measuring table | aluminum blue anodized | incl. mounting material

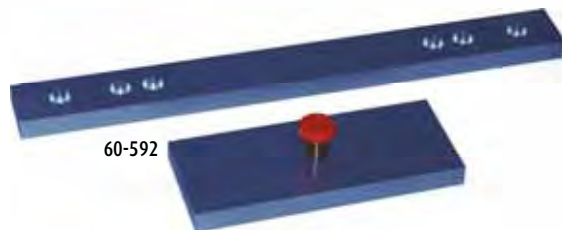

Art.-Nr. Order no.	für Gerät for device	für Messtisch for measuring table	Abmessungen dimensions	EUR
60-591	VP-160LCD VP-200Tab	25x25 mm 50x25 mm	Leiste bar: 110x20 mm Platte plate: 60x30 mm	66,50
60-592	CZM CZM-Basic	100x100 mm 200x100 mm 300x200 mm	Leiste bar: 260x28 mm Platte plate: 120x50 mm	86,00

Mini-Präzisionsschraubstock *Mini precision bench vice*

Grundkörper aus Aluminium, blau eloxiert | Spannbacken mit vertikalen und horizontalen Prismen | Magnetfläche zur Teilefixierung
base made of aluminum, blue anodized | jaws with vertical and horizontal prisms | magnet for fixing parts



Art.-Nr. Order no.	Backenbreite jaw width	Spannweite range	EUR
60-577	15 mm	13 mm	88,00
60-576	25 mm	30 mm	98,00

Satz aus 60-577 und 60-576:
Set consisting of 60-577 and 60-576:

Art.-Nr. Order no.	EUR
60-578	169,00

Prismensatz *Set of prisms*



zum Positionieren von rotationssymmetrischen Teilen für optische Messungen | 3teilig |
Abmessungen: 10/20/50x40x37,5 mm | großes Prisma mit verstellbarem Anschlag | Aluminium blau eloxiert
for positioning of axially symmetric parts for optical measuring | consisting of 3 parts |
dimensions: 10/20/50x40x37.5 mm | large prism with adjustable stop | aluminum blue anodized

Art.-Nr. Order no.	EUR
60-582	57,50

Variables Prisma *Variable prism*



zum Positionieren von rotationssymmetrischen Teilen für optische Messungen | Abmessungen:
ca. 120x80x40 mm | Prismenabstand einstellbar 0-90 mm | Aluminium blau eloxiert / Acrylglas
for positioning of axially symmetric parts for optical measuring | dimensions: approx. 120x80x40 mm |
distance between prisms adjustable 0-90 mm | aluminum blue anodized / acrylic glass

Best.- Nr.	EUR
60-586	59,00

Tools für die optische Messtechnik im Satz *Set of tools for optical measuring technology*

bestehend aus Mini-Präzisionsschraubstöcken 60-576 und 60-577, Prismensatz 60-582 und variablem Prisma 60-586
consisting of mini precision bench vices 60-576 and 60-577, set of prisms 60-582 and variable prism 60-586



Art.-Nr. Order no.	EUR
60-589	269,00

Lupen, Leuchten, Mikroskope

Loupes, lamps, microscopes

LED-Schwanenhals LED swan neck



2armig | Befestigung über 2 Bohrungen Ø4,5 mm | Beleuchtungsstärke regelbar | inkl. Netzteil
 230 V | Made in Germany
 2 arms | mounting: 2 holes Ø4.5 mm | intensity of light adjustable | incl. power supply unit
 230 V | Made in Germany

Art.-Nr. Order no.	EUR
60-566	285,00

Ersatz-HighPower-LED-Element:
 spare part HighPower-LED-unit:

Art.-Nr. Order no.	EUR
60-566L	44,50

LED-Ringlicht LED ring light

flackerfreies Licht | homogene gleichmäßige Ausleuchtung | pur-weiß (6500 K) | Beleuchtungsstärke regelbar | inkl. Netzteil | Made in Germany
 free from flickering | homogeneous smooth illumination | pure-white (6500 K) | intensity of light adjustable | incl. power supply | Made in Germany



60-521

Art.-Nr. Order no.	Typ type	Aufnahme seat	Anzahl LEDs number of LEDs	EUR
60-520	RL2	Ø40 mm	24	273,00
60-521	RL4	Ø40-60 mm	48	309,00

Zubehör accessories:



60-528

Art.-Nr. Order no.	für Typ for type	Beschreibung Description	EUR
60-527	RL2	Streuscheibe Diffusion disc	38,50
60-528			55,50
60-529	RL4	Polarisationsfilter Polarisation filter	204,00

Weitere Größen/Lichtfarben auf Anfrage!
 Further sizes/light colours on request!

LED-Beleuchtungssystem LED illumination system

Lichtsteuerung für Unterlicht und Ringlicht | separate Steuerung von innerem und äußerem LED-Ring | 4 Segmente individuell steuerbar | flackerfreies Licht | maximale Beleuchtungsvariabilität und homogene gleichmäßige Ausleuchtung | Ringlichter und Unterlichter inkl. Anschlusskabel | Made in Germany
 light control for bottom and top light | independent control of inside and outside LED ring | maximum variability of light and homogeneous smooth illumination | free from flickering | 4 segments individually adjustable | ring lights and bottom lights incl. connecting cable | Made in Germany



60-801

Lichtsteuerung (inkl. Netzkabel 230 V):
 light control (incl. power cable 230 V):

Art.-Nr. Order no.	EUR
60-801	298,00

Ringlicht:
 ring light:

Art.-Nr. Order no.	Aufnahme seat	Anzahl LEDs number of LEDs	Beleuchtungsstärke illumination level	EUR
60-805	Ø25 mm	32 Stk. pcs. (1 Ring)	200.000 Lux	185,00
60-807	Ø41 mm	24+32 Stk. pcs. (2 Ringe rings)	300.000 Lux	277,00



60-807

Unterlicht:
 bottom light:



60-561

Art.-Nr. Order no.	Abmessung (ohne Laschen) dimensions (without hangers)	Anzahl LEDs number of LEDs	Beleuchtungsstärke illumination level	EUR
60-561	70x60x30 mm	35 Stk. pcs.	170.000 Lux	148,00
60-563	50x45x20 mm	16 Stk. pcs.	125.000 Lux	89,00

Z-Säule Z-pillar



60-822

für Ihre individuelle Messmikroskop-Lösung | Querarm 143 mm | Befestigung 3x M5 | Schlitten selbsthemmend mit justierbarer Bremse
for your individual measuring microscope solution | transverse arm 143 mm | mounting 3x M5 | self-impeding sliding carriage with adjustable brake

Art.-Nr. Order no.	Länge Length	Verfahrweg Range	EUR
60-822	495 mm	315 mm	659,00
60-823	695 mm	515 mm	859,00

Andere Ausführungen auf Anfrage!
Further variants on request!

Zoom-Kopf Zoom unit



für Ihre individuelle Messmikroskop-Lösung | Zoombereich 0,8-4,0 (5fach) | mit Ringschwalbe für C-Mount-Adapter | Arbeitsabstand 80 mm | für Ringlicht Ø41 mm | Abmessung 60x60x122 mm
for your individual measuring microscope solution | zoom range 0.8-4.0 (5-fold) | with ring dovetail joint for C-Mount-Adaptor | working distance 80 mm | for ring light Ø41 mm | dimensions 60x60x122 mm

Art.-Nr. Order no.	EUR
69-001	1530,00

LD-Kopf für Objektive mit Festvergrößerung LD unit for lens with fixed magnification



für Ihre individuelle Messmikroskop-Lösung | Objektivbereich 0,8-6,3x | für LD-Objektive 69-111 bis 69-114 (siehe unten) | mit Ringschwalbe für C-Mount-Adapter | für Ringlicht Ø41 mm | Abmessung 60x60x44 mm
for your individual measuring microscope solution | lens range 0.8-6.3x | for LD lens 69-111 to 69-114 (see below) | with ring dovetail joint for C-Mount-Adaptor | for ring light Ø41 mm | dimensions 60x60x44 mm

Art.-Nr. Order no.	EUR
69-101	174,00

LD-Objektive mit Festvergrößerung LD lens with fixed magnification



69-114

für Ihre individuelle Messmikroskop-Lösung | für LD-Kopf 69-101
for your individual measuring microscope solution | for LD unit 69-101



69-111

Art.-Nr. Order no.	Vergrößerung magnification	Sehfeld visual field	Arbeitsabstand working distance	EUR
69-111	0,8x	20 mm	132 mm	317,00
69-112	1,6x	10 mm	124 mm	283,00
69-113	3,2x	5 mm	77 mm	294,00
69-114	6,3x	2,5 mm	65 mm	398,00

Vorsatzlinsen (inkl. Adapter) für weitere Vergrößerungen/Sehfelder auf Anfrage!
Lenses (incl. adaptors) for further magnifications/visual fields on request!

Lupen, Leuchten, Mikroskope

Loupes, lamps, microscopes

CCD-USB-Kamera CCD USB camera

für Ihre individuelle Messmikroskop-Lösung | hochwertige CCD-Kamera mit hochauflösendem Sensor und optimierter Lichtempfindlichkeit | Auflösung 1280x1024 Pixel | USB 2.0 oder USB 3.0 | Spannungsversorgung über USB-Schnittstelle | C-Mount-Anschlussgewinde | für alle Varianten unserer Video-Software | Made in Germany

for your individual measuring microscope solution | high-quality CCD camera with high resolution sensor and optimized light sensitivity | resolution 1280x1024 pixel | USB 2.0 or USB 3.0 | power supply via USB interface | C-Mount connection thread | for all variants of our video software | Made in Germany



USB 2.0



USB 3.0

Anschlusskabel USB, Länge 3 m:
connecting cable USB, length 3 m.

*verschraubbar screwable

Art.-Nr. Order no.	USB	CCD	EUR
60-541	2.0	1/2"	578,00
60-543		1/3"	395,00
60-544	3.0	1/2"	595,00

Art.-Nr. Order no.	USB	EUR
02-1009	2.0	5,90
02-1104*	3.0	32,50

Positioniertisch Positioning table



für Ihre individuelle Messmikroskop-Lösung | Positionierbereich 70x50 mm | Probenaufgabe Mattglas | für Durchlichtbeleuchtung geeignet

for your individual measuring microscope solution | range 70x50 mm | sample support from satin-finished glass | suitable for bottom light

Art.-Nr. Order no.	EUR
60-077	174,00

Kreuz-Messtisch Measuring table



manueller Messtisch für Ihre individuelle Mess-Aufgabe | Mikrometernaufnahme Ø12 mm | Probenaufgabe Mattglas Ø100 mm | für Durchlichtbeleuchtung geeignet | Befestigung: 4xM5 (90x90 mm) im Tischunterteil | Lieferung ohne Mikrometerschrauben

manual measuring table for your individual measuring task | micrometer seat Ø12 mm | sample support from satin-finished glass Ø100 mm | suitable for bottom light | mounting: 4xM5 (90x90 mm) in base of table | without micrometers



Art.-Nr. Order no.	Messbereich Range	EUR
B023-010	25x25 mm	518,00
B023-012	50x50 mm	518,00

Fußtaster Foot switch



zum Anschließen an QT-Interfaceboxen oder für die Messmikroskope CZM-Basic/CZM | Abmessung 100x65 mm | Metallgehäuse | inkl. Anschlusskabel

for connecting with QT interface boxes or for the measuring microscopes CZM-Basic/CZM | dimensions 100x65 mm | metal housing | incl. connecting cable

Art.-Nr. Order no.	EUR
50-902	29,00

Video-Software für Mikroskope *Video software for microscopes*

für PCs mit Betriebssystem Windows 7/10 mit min. 2 GB Arbeitsspeicher, 500 MB Festplattenspeicher und einem Monitor mit Full-HDAuflösung 1920x1080 in Verbindung mit einer unserer CCD-Kameras 60-541/60-543/60-544 (siehe vorherige Seite!) | Videobild-Eingang über USB-Schnittstelle
for PCs with operating system Windows 7/10 with min. RAM 2 GB, hard disk memory 500 MB and monitors with FullHD resolution 1920x1080 together with one of the cameras 60-541/60-543/60-544 (see previous page!) | Video input via USB-interface

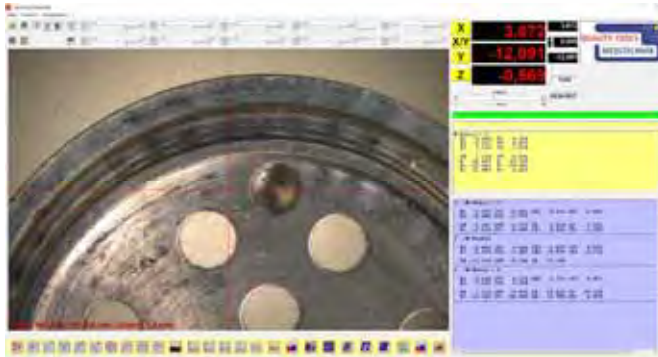

Darstellung Live-Bild, Hilfslinien und Messwerte
Illustration Live picture, reference lines and measured values



Übersicht der enthaltenen Mess-/Ausricht-Modi
Overview of included modes measuring/offset

Funktion/ Merkmal	function/ feature	Software „WinGeo2dVideoUSB“	Software „WinVideoUSB“	Software „WinLiveVideoUSB“
Live-Videobild-Darstellung	<i>Illustration of Live video</i>	x	x	x
Messen geometrischer Elemente im 2D-Modus	<i>Measuring of geometric elements in 2D-mode</i>	x		
In-Bild-Messung geometrischer Elemente im 2D-Modus	<i>In-picture-measuring of geometric elements in 2D-mode</i>	x	x	
Ausricht-Modus	<i>Offset mode</i>	x	x	
Einblendung von Hilfslinien, Kreisen und Raster in Live-Bild	<i>Overlay of reference lines, circles and raster into live video</i>	x	x	x
Zeichen-Modus mit Möglichkeit zum Beschriften der Bilder	<i>Drawing mode with picture labelling</i>	x	x	
Bild drucken	<i>Printing picture</i>	x	x	x
Bild in Windows-Zwischenablage übergeben	<i>Copy picture to Windows clipboard</i>	x	x	x
Überlagerung des Live-Bildes mit BMP-Bildern	<i>Overlay live video with BMP-pictures</i>	x	x	x
Überlagerung des Live-Bildes mit CAD-Zeichnungen im DXF-Format	<i>Overlay live video with CAD-drawing in DXF-format</i>	x	x	
Messprotokolle speichern/drucken	<i>Saving/printing measuring reports</i>	x	x	
Messprogramm-Modus (inkl. Lernprogramm und Messprogramm-Editor)	<i>Measuring program mode (incl. learn program and editor for measuring programs)</i>	x		
Export der Messdaten über RS232-Schnittstelle	<i>Export of measuring results via RS232 interface</i>	x		
Export der gemessenen X-/Y-Werte direkt an ein anderes Windows-Programm (Excel®, CAQ-System, etc.)	<i>Export of X-/Y-values directly to another Windows program (Excel®, CAQ system, etc.)</i>	x		
Art.-Nr. Order no.		61-001	61-021	61-041
EUR		1700,00	900,00	600,00

Software-Updates:
 (auf aktuelle Version *to current version*)

Art.-Nr. Order no.	Software	EUR
95-002	WinGeo2dVideoUSB (<4 Jahre <i>years</i>)	190,00
95-006	WinGeo2dVideoUSB (>4 Jahre <i>years</i>)	240,00
95-010	WinVideoUSB	130,00
95-015	WinLiveVideoUSB	90,00

Profilprojektoren

Profile projectors



- 01
- 02
- 03
- 04
- 05
- 06
- 07
- 08
- 09
- 10
- 11
- 12
- 13
- 14
- 15

Inhalt Contents



13.2



13.3



13.5

Kalibrierung Calibration

Wir kalibrieren Ihren Profilprojektor! Lassen Sie sich ein individuelles Angebot machen...
We calibrate your profile projector! Please ask for an individual offer...

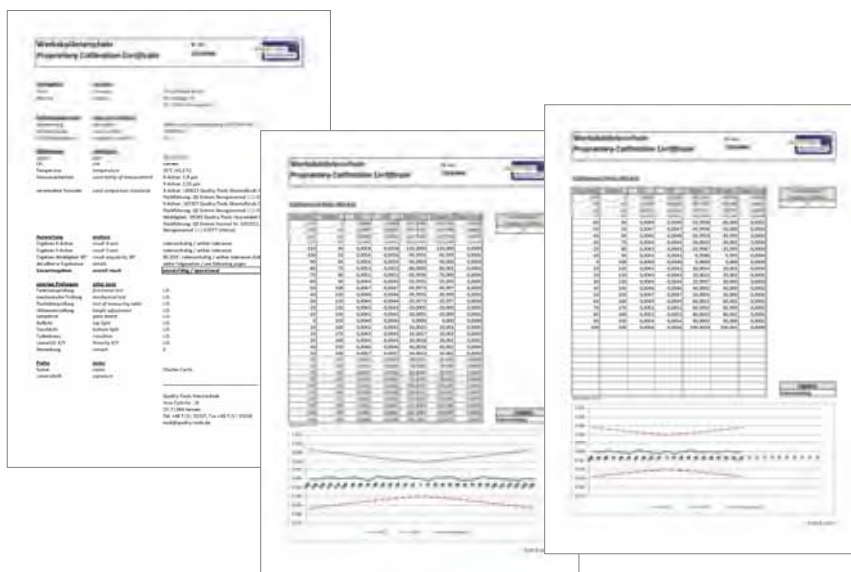

Profilprojektoren Profile projectors

Profilprojektor VP-160LCD Profile projector VP-160LCD

Leichter, kompakter Profilprojektor mit Kamera/LCD-Technik zum **Betrachten und Messen** | einfache Bedienung: Werkstück auflegen – Abnullen – Messposition anfahren – Messwert ablesen | Zoom-Vergrößerung 10-80fach | Sehfeld in X-Richtung: 17-2 mm | Auflösung 0,001 mm | Arbeitsabstand 110 mm | 8"-Farb-LCD-Display mit Fadenkreuz | LED-Auf-/Durchlicht | optional: LED-Ringlicht | mit Winkel-Tabellen zur Winkelbestimmung | Gewicht ca. 7 kg

Lightweight, compact profile projector with camera/LCD technology for observing and measuring | simple use: place workpiece on table - zero - move to measuring position - read measuring result | zoom magnification 10-80x | camera coverage X: 17-2 mm | resolution 0.001 mm | working distance 110 mm | 8"-colour-LCD-display with crosslines | halogen top/bottom light | optional: LED ring light (accessory) | with appendix for determining angles | weight approx. 7 kg



63-401

Art.-Nr. Order no.	Messbereich Range	Genauigkeit Accuracy	EUR
63-401	25x25 mm	0,004 mm	1690,00
63-402	50x25 mm	0,006 mm	1840,00

Zubehör accessories:

Art.-Nr. Order no.	Bezeichnung description	EUR
60-520	LED-Ringlicht RL2 LED ring light RL2	273,00
60-591	Anschlagleisten-Set Set of stop bars	66,50

Profilprojektor VP-200Tab Profile projector VP-200Tab

Leichter, kompakter Profilprojektor mit Kamera/Tablet-PC-Technik, zum **Betrachten, Messen und Dokumentieren** | Vergrößerung 10-80x | Sehfeld in X-Richtung: 17-2 mm | Auflösung 0,001 mm | Arbeitsabstand 110 mm | Tablet-PC Windows 10 FullHD mit USB-Schnittstelle, WLAN und Videobild-Software | Software-Funktionen: Einblenden von Fadenkreuz, Linien, Kreisen, Text, Datum-/Zeitstempel; Bilder speichern, Videosequenzen aufnehmen; verschiedene Bildparameter verstellbar, mehrsprachig | LED-Auf-/Durchlicht | optional: LED-Ringlicht (Zubehör) | Gewicht ca. 7 kg

Lightweight, compact profile projector with camera/tablet-PC technology, for observing, measuring and documenting | Magnification 10-80x | camera coverage X: 17-2 mm | resolution 0.001 mm | working distance 110 mm | Tablet-PC Windows 10 FullHD with USB-interface, Wi-Fi and video software | software features: overlaying cross lines, lines, circles, text, date and time; saving pictures, grabbing videos; adjustable picture parameters, multilingual | halogen top/bottom light | optional: LED ring light (accessory) | weight approx. 7 kg



63-451

Art.-Nr. Order no.	Messbereich Range	Genauigkeit Accuracy	EUR
63-451	25x25 mm	0,004 mm	2145,00
63-452	50x25 mm	0,006 mm	2295,00

Zubehör accessories:

Art.-Nr. Order no.	Bezeichnung description	EUR
60-520	LED-Ringlicht RL2 LED ring light RL2	273,00
60-591	Anschlagleisten-Set Set of stop bars	66,50
61-041*	Software WinLiveVideoUSB	600,00

*ersetzt die enthaltene Standard-Software, Funktionsbeschreibung siehe Kapitel 12!
replaces the included standard software, description of functions please see chapter 12!

Profilprojektoren Profile projectors

Profilprojektor VP-300 Profile projector VP-300

Konventioneller Vertikal-Tisch-Profilprojektor | mit Geometrie-Messrechner für X/Y/Winkel/Punkt/ Linie/Abstand/Kreis | 10fach-Objektiv | Auflösung 0,001 mm/0,01° | Messbereich 150x50 mm | Genauigkeit (4+L/25) µm | feingeschliffene Glasmattscheibe Ø300 mm mit Fadenkreuz | Auf- und Durchlicht | max. Werkstückhöhe 80 mm | Tischbelastung max. 10 kg | Abmessung ca. 780x480x1150 mm | Gewicht ca. 135 kg | Bediener Sprache Englisch | inklusive Werkskalibrierzeugnis rückführbar auf DKD-Normal

Conventional Vertical-Table-Profile Projector | with geometry computer for X/Y/angle/ point/line/distance/circle | 10x-lens | resolution 0.001 mm/0.01° | range 150x50 mm | accuracy (4+L/25) µm | fine ground glass screen Ø300 mm with crosslines | bottom and top light | max. height of workpiece 80 mm | table load max. 10 kg | dimensions approx. 780x480x1150 mm | weight approx. 135 kg | user language English | incl. proprietary calibration certificate traceable to DKD standard



Art.-Nr. Order no.	EUR
63-501	5490,00

<u>Zubehör:</u> <u>Accessories:</u>	Art.-Nr. Order no.	Bezeichnung description	EUR
	63-541	Geometrieschablone* Kreise/Winkel Geometry template* circles/angles	84,00
	63-570	Objektiv lens 10x**	525,00
	63-571	Objektiv lens 20x	525,00
	63-572	Objektiv lens 50x	525,00

<u>Ersatzlampen:</u> <u>spare part lamps:</u>	Art.-Nr. Order no.	Lampe lamp	EUR
	63-512	Auflicht top light	4,70
	63-511	Durchlicht bottom light	7,80

*anpassbar, für Profilprojektoren bis max. Ø300 mm
adaptable, for profile projectors up to Ø300 mm

**im Lieferumfang von 63-501 enthalten
included in standard delivery of 63-501

01



02



03



04



05



06



07



08



09



10



11



12



13



14



15



NIKON Profilprojektor V-12B *Profile projector V-12B*



Vertikal-Tisch-Profilprojektor | Glasmattscheibe Ø305 mm mit Fadenkreuz | Scheibe um 360° drehbar mit digitaler Winkelanzeige, Auflösung 1 Winkelminute (nur 75-004) | eingebaute X-/Y-Digital-Anzeige mit Auflösung 1 µm oder 0,5 µm | Revolverkopf zur Aufnahme von bis zu 3 Objektiven | Vergrößerungs-Objektive von 5x bis 200x wählbar | Messtische mit max. Messbereich von 50x50 bis 250x150 mm wählbar | Vertikal- und Schräglicht | max. Werkstückhöhe 100 mm (bei Messtisch 250x150 mm nur 70 mm) | Abmessung ca. 409x648x970-1070 mm | Gewicht ca. 80 kg



Vertical-Table-Profile Projector | fine ground glass screen Ø305 mm with crosslines | screen 360° rotatable with digital protractor, reading 1 minute of arc (only 75-004) | built-in digital counter X/Y with resolution 1 µm or 0.5 µm | Rotary turret for mounting up to 3 projection lenses | Projection lenses from 5x to 200x selectable | Measuring tables with maximum ranges from 50x50 mm up to 250x150 mm selectable | vertical and oblique illumination | max. height of workpiece 100 mm (measuring table 250x150 mm only 70 mm) | dimensions approx. 409x648x970-1070 mm | weight approx. 80 kg

Grundgerät*:
Basic device:*

Art.-Nr. Order no.	digitaler Winkelmesser built-in digital protractor	EUR
75-003		9970,00
75-004	X	10930,00

*ohne Messtisch und ohne Objektive
**w/o measuring table and w/o projection lens*

75-004 mit 75-015 (Messtisch 200x150 mm) und 3 Stück Objektive 75-02...
75-004 with 75-015 (measuring table 200x150 mm) and 3 pieces projection lenses 75-02...

Messtische (mit linearen Messgebern X/Y):
Measuring tables (with linear encoders X/Y):

Art.-Nr. Order no.	Messbereich Range	max. Tischbelastung max. table load	EUR
75-011*	50x50 mm	5 kg	3325,00
75-013	100x100 mm	6 kg	5325,00
75-014	150x100 mm	10 kg	8990,00
75-015	200x150 mm	15 kg	10760,00
75-016	250x150 mm	20 kg	12285,00

*360° drehbar *rotatable*



Objektive:
Projection lenses:

Art.-Nr. Order no.	Vergrößerung Magnification	Sichtfeld (Ø) Field of view	Arbeitsabstand Working distance	EUR
75-021	5x	61 mm	60 mm	1740,00
75-022	10x	30 mm	74 mm	990,00
75-023	20x	15 mm	74 mm	990,00
75-025	50x	6 mm	61 mm	1175,00
75-026	100x	3 mm	50 mm	1175,00

Zubehör:
Accessories:

Art.-Nr. Order no.	Bezeichnung Description	EUR
75-031	Drehtisch für Messbereiche 100x100 und 150x100 mm <i>Rotating table for range 100x100 and 150x100 mm</i>	645,00
75-032	Drehtisch für Messbereiche 200x150 und 250x150 mm <i>Rotating table for range 200x150 and 250x150 mm</i>	1690,00

Weitere Modelle und Zubehör auf Anfrage!
Further models and accessories on request!

DYNASCAN Automatischer Messprojektor *Automatic Measuring projector*

automatische, berührungslose, bedienerunabhängige Messung auf Knopfdruck (2D) | telezentrisches Präzisionsobjektiv | hochauflösende CMOS-Digitalkamera 5 Megapixel | Auflösung 0,001 mm | Auf- und Durchlicht über Software regelbar | automatische Teile-Identifikation (beliebige Lage) | mehrere Teile gleichzeitig messbar | max. Teilehöhe 70 mm | inkl. mehrsprachiger, einfach zu bedienender Messsoftware mit großem Funktionsumfang (Linien, Radien, Bohrungen, Abstände, Winkel), automatischer Kantenerkennung, definierbare Toleranzen (Länge, Durchmesser, Winkel, Fläche, Konzentrität), statistischen Auswertungen, Datenimport/-export (DXF-Dateien, Messprotokolle) | für Touchscreen oder konventionellen PC

automatic non-contact user-independent measurements at the push of a button (2D) | telecentric precision lens | high resolution CMOS digital camera 5 megapixel | resolution 0.001 mm | top and bottom light adjustable by software | automatic part recognition (any position) | multiple parts measuring mode | max. height of parts 70mm | incl. multi-language easy-to-use measuring software with many functions (lines, arcs, circles, distances, angles), automatic edge detection, definable tolerances (length, diameter, angles, area, concentricity), statistical analysis, data import/export (DXF files, measuring record) | for touchscreen or conventional PC

DYNASCAN
Inspection Systems Company



Art.-Nr. Order no.	Messbereich* Range*	Genauigkeit (µm) Accuracy (µm)	Abmessungen dimensions	Gewicht weight	EUR
63-701	42x32 mm	2 + L/50	245x175x532 mm	15 kg	13900,00
63-702	86x65 mm	4 + L/50	350x250x760 mm	25 kg	16600,00
63-703	140x118 mm	6 + L/50	785x270x630 mm	45 kg	19800,00

*Messbereich mit kleiner Fase in den Ecken *Range with small corner chamfers*

Zubehör *accessories:*

Art.-Nr. Order no.	Bezeichnung description	EUR
61-108	Messrechner (Desktop-PC, Win 10) inkl. 24"-FullHD-LED-Monitor <i>Measuring computer (Desktop-PC, Win 10) incl. 24"-FullHD-LED-monitor</i>	785,00

inkl. Software
incl. software:



1. Konturen eines Musterteils erfassen
 2. zulässige Toleranzen definieren
 3. automatisch Vermessen lassen
 4. Daten auswerten/exportieren
1. Capture outline of sample
 2. Define acceptable tolerances
 3. Measure automatically
 4. Analyze/export data

No.	Element	Koort.	Software	istwert	Tol-	Tol+	Abw.	Toleranz
0	Abst. T1	X		20.048				
0	Abst. T1	Y		0.244				
0	Abst. T1	L	30.000	20.047	0.010	0.010	0.047	
0	Winkel 112	W	112.000°	112.009°	1.000°	1.000°	0.009°	

Bitte kontaktieren Sie uns für eine Vorführung!
Please contact us for a demonstration!

Sonstige Messgeräte

Other measuring instruments



Inhalt *Contents*



14.2



14.5



14.7



14.8



14.11



14.12



14.14



14.15



14.16



14.16



14.16



Sonstige Messgeräte Other measuring instruments

KERN Mini-Waage *Small scales*

Einfache Bedienung | Abdeckung aus stoßfestem Kunststoff (kann auch als Taragefaß verwendet werden) |
Abmessung Wägeplatte 60x64 mm | Gesamtabmessungen 67x100x22 mm | beleuchtetes LCD-Display |
batteriebetrieben

*simple operation | cover made from shock-proof plastics (may also be used as weighing container) |
dimensions of weighing table 60x64 mm | total dimensions 67x100x22 mm | illuminated LCD-display |
battery-powered*



Größendarstellung
Illustration of size



Anwendungsbeispiel mit Deckel als Taragefaß
Example of use with cover as weighing container



KERN

Art.-Nr. Order no.	Wägebereich Range	Auflösung Reading	EUR
49-501	150 g	0,1 g	39,50

KERN Taschen-Waage *Pocket scales*

Integrierter Taschenrechner | Klappdeckel als Druck- und
Staubschutz | Abmessung Wägeplatte 70x80 mm |
Gesamtabmessungen 85x130x25 mm | batteriebetrieben

*Integrated electronic calculator | hinged cover used as protection
from stress and dust | dimensions of weighing table 70x80 mm |
total dimensions 85x130x25 mm | battery-powered*



49-512

KERN

Art.-Nr. Order no.	Wägebereich Range	Auflösung Reading	EUR
49-511	60 g	0,01 g	77,50
49-512	150 g	0,1 g	49,00
49-513	320 g	0,1 g	54,00
49-514	1000 g	1 g	51,00

KERN Präzisionswaage *Precision scales*

Großes LCD-Display, Ziffernhöhe 25 mm | Abmessung Wägeplatte Ø105 mm (nur 49-551, inkl. Windschutz) / 175x190
mm (alle anderen Versionen) | flache Bauweise | große, stoßfeste Kunststoff-Wägeplatte | Stückzählen-Funktion |
inkl. Netzteil (Batteriebetrieb möglich, Batterie nicht im Lieferumfang)

*Large LCD-display, size of digits 25 mm | dimensions of weighing table Ø105 mm (only 49-551, incl. wind shield) /
175x190 mm (all other models) | flat design | large, shock-proof weighing table from plastics | piece counter
function | incl. power supply (operation by battery possible, battery not included)*



49-555

KERN

Art.-Nr. Order no.	Wägebereich Range	Auflösung Reading	Reproduzierbarkeit Repeatability	Linearität Linearity	EUR
49-551	300 g	0,001 g	0,002 g	±0,005 g	255,00
49-552	3000 g	0,01 g	0,02 g	±0,05 g	236,00
49-553	6000 g	0,1 g	0,1 g	±0,3 g	157,00
49-554	12000 g	0,1 g	0,1 g	±0,3 g	199,00
49-555	6000 g	1 g	1 g	±3 g	78,50
49-556	12000 g	1 g	1 g	±3 g	83,50

Sonstige Messgeräte Other measuring instruments

KERN Präzisionswaage Edelmetall Precision scales stainless steel

Großes hinterleuchtetes LCD-Display, Ziffernhöhe 15 mm | Abmessung 163x245x79 mm | Edelstahl-Wägeplatte | Stückzählen-Funktion | frei programmierbare Wägeeinheit (z. B. Papiergewicht g/m²) | Plus/Minus-Wägungen | RS232-Schnittstelle | inkl. Netzteil (Batteriebetrieb möglich, Batterie nicht im Lieferumfang)

Large illuminated LCD-display, size of digits 15 mm | dimensions 163x245x79 mm | weighing table from stainless steel | piece counter function | user-defined programming of weighing unit (e. g. weight of paper g/m²) | Plus/Minus weighing | RS232 interface | incl. power supply (operation by battery possible, battery not included)

KERN



49-569

Art.-Nr. Order no.	Wägebereich Range	Auflösung Reading	Reproduzierbarkeit Repeatability	Linearität Linearity	Wägeplatte Weighing table	EUR
49-564	1000 g	0,01 g	0,01 g	±0,03 g	130x130 mm	269,00
49-566	3500 g		0,02 g	±0,05 g		295,00
49-567	1000 g	0,1 g	0,1 g	±0,2 g	150x170 mm	182,00
49-569	6000 g			±0,3 g		236,00
49-570	10000 g			241,00		
49-571	6000 g	1 g	1 g	±2 g		179,00

KERN Plattform-Waage bis 120 kg Platform scales up to 120 kg

Edelstahl-Wägeplatte 318x308x75 mm | frei positionierbares Auswertegerät, staub- und spritzwassergeschützt gemäß IP 65 | Großes hinterleuchtetes LCD-Display, Ziffernhöhe 25 mm | Stückzählen-Funktion | frei programmierbare Wägeeinheit (z. B. Papiergewicht g/m²) | Plus/Minus-Wägungen | RS232-Schnittstelle | Kabellänge 1,4 m | inkl. Netzteil (Batteriebetrieb möglich, Batterie nicht im Lieferumfang)

Stainless steel weighing table 318x308x75 mm | flexible positioning of display device, protected against dust and water splashes according to IP65 | Large illuminated LCD-display, size of digits 25 mm | piece counter function | user-defined programming of weighing unit (e. g. weight of paper g/m²) | Plus/Minus weighing | RS232 interface | length of cable 1.4 m | incl. power supply (operation by battery possible, battery not included)

KERN



Art.-Nr. Order no.	Wägebereich Range	Auflösung Reading	Reproduzierbarkeit Repeatability	Linearität Linearity	Kleinstes Teilgewicht Minimum piece weight	EUR
49-521	6 kg	0,5 g	0,5 g	±1,5 g	10 g	209,00
49-522	12 kg	1 g	1 g	±3 g	20 g	209,00
49-523	24 kg	2 g	2 g	±6 g	40 g	209,00
49-524	60 kg	5 g	5 g	±15 g	100 g	209,00
49-525	120 kg	10 g	10 g	±30 g	200 g	209,00

Sonstige Messgeräte Other measuring instruments

KERN Prüfgewichte Test Weights

Material Edelstahl | Genauigkeitsklasse M1 | einzeln oder im Satz (Sätze inkl. Holz-Aufbewahrungsbox) | optional gepolsterte Kunststoff-Aufbewahrungsbox
material stainless steel | Accuracy class M1 | individual or set (sets incl. wooden box) | optional lined plastic box

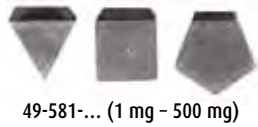

49-581-... (1 mg - 500 mg)



49-582-...
49-583-...

Einzelgewichte individual weights			
Art.-Nr. Order no.	Gewicht weight	Genauigkeit Accuracy	EUR
49-581-001	1 mg	0,20 mg	3,90
49-581-002	2 mg	0,20 mg	3,90
49-581-005	5 mg	0,20 mg	3,90
49-581-010	10 mg	0,25 mg	3,90
49-581-020	20 mg	0,3 mg	3,90
49-581-050	50 mg	0,4 mg	3,90
49-581-100	100 mg	0,5 mg	3,90
49-581-200	200 mg	0,6 mg	3,90
49-581-500	500 mg	0,8 mg	3,90
49-582-001	1 g	1,0 mg	4,50
49-582-002	2 g	1,2 mg	4,80
49-582-005	5 g	1,6 mg	5,30
49-582-010	10 g	2,0 mg	5,80
49-582-020	20 g	2,5 mg	6,90
49-582-050	50 g	3,0 mg	8,80
49-582-100	100 g	5,0 mg	10,80
49-582-200	200 g	10 mg	14,50
49-582-500	500 g	25 mg	29,50
49-583-001	1 kg	50 mg	44,50
49-583-002	2 kg	100 mg	79,50
49-583-005	5 kg	250 mg	176,00
49-583-010	10 kg	500 mg	342,00



49-585-...

Aufbewahrungsbox für Einzelgewichte plastic box for individual weights		
Art.-Nr. Order no.	für Einzelgewicht for individual weight	EUR
49-585-0	1 mg - 500 mg	2,00
49-585-1	1 g - 5 g	2,00
49-585-2	10 g - 20 g	2,00
49-585-3	50 - 100 g	2,00
49-585-4	200 g	2,00
49-585-5	500 g	3,00
49-585-6	1 kg	3,00
49-585-7	2 kg	4,00
49-585-8	5 kg	9,00
49-585-9	10 kg	9,00



49-587-...
49-588-...

Gewichtssätze Weight sets		
Art.-Nr. Order no.	Gewichte weights	EUR
49-587-1	1 mg - 50 g	173,00
49-587-6	1 mg - 1 kg	386,00
49-587-9	1 mg - 10 kg	1075,00
49-588-3	1 g - 100 g	129,00
49-588-6	1 g - 1 kg	298,00
49-588-9	1 g - 10 kg	995,00

Prüfgewichte mit anderen Genauigkeitsklassen auf Anfrage!
Test weights with other accuracy classes on request!

Sonstige Messgeräte

Other measuring instruments

KERN Feuchtebestimmer *Moisture Analyzer*

zum Bestimmen der Feuchtigkeit z. B. in der Kunststoffverarbeitung | hinterleuchtetes LCD-Display, Ziffernhöhe 14 mm | Halogen-Quarzglasstrahler 400W | waageninterner Speicher für den automatischen Ablauf von 15 Trocknungsprogrammen | Sichtfenster auf die Probe | Abmessung 240x365x180 mm | RS232-Schnittstelle | Applikationshandbuch mit vielen Beispielen, Erfahrungsberichten, Einstellungen und Tipps downloadbar im Internet
for determination of moisture e. g. in plastics processing | illuminated LCD-display, size of digits 14 mm | halogen quartz glass heater 400 W | internal memory for automatic sequence of 15 complete drying processes | observation window above the sample | dimensions 240x365x180 mm | RS232 interface | application handbook containing many examples, field reports, settings and tips can be downloaded from Internet

KERN



Art.-Nr. Order no.	EUR
49-591	1029,00

ACCUD Schichtdickenmessgerät *Coating thickness gauge*

zum Messen der Dicke von nicht-magnetischen Beschichtungen (z. B. Lack, Kunststoff, Zink, Kupfer, usw.) auf magnetischen Grundstoffen (z. B. Eisen, Stahl) | Messbereich 0-1250 µm | Auflösung 0,1 µm (1 µm ab 1000 µm) | Genauigkeit 2,5 µm (2,5% ab 100 µm) | Einzelmessung oder kontinuierliche Messung | Speicher für 500 Messwerte | Toleranzgrenzen einstellbar | Durchschnittswertkalkulation | Bedienersprache Englisch | inkl. Kalibrierfolie und Batterien | Kunststoffbox
to measure the thickness of non-magnetic coatings (e. g. enamel, plastics, zinc, copper) on magnetic base materials (e. g. iron, steel) | range 0-1250 µm | resolution 0.1 µm (1 µm from 1000 µm) | accuracy 2 µm (2% from 100 µm) | single or continuous working mode | memory for 500 measuring values | tolerance limits adjustable | average calculation function | user language English | incl. calibration foil and batteries | plastics box

ACCUD



Art.-Nr. Order no.	EUR
70-011	198,00

01



02



03



04



05



06



07



08



09



10



11



12



13



14



15



Sonstige Messgeräte Other measuring instruments

SAUTER Schichtdickenmessgerät *Coating thickness gauge*

zum Messen der Dicke von unterschiedlichen Materialien (siehe Tabelle) | externer Messkopf | Messbereich 0-1000 µm | Auflösung 0,1 µm (1 µm ab 100 µm) | Genauigkeit 3% (1% mit Offset-Accur) | kleinste Messfläche 6 mm | minimale Stärke des Grundmaterials 0,3 mm | inkl. Nullplatte, Justierfolien und Batterien | Lieferung im robusten Tragekoffer
to measure the thickness of different materials (look at list) | external sensor | range 0-1000 µm | resolution 0.1 µm (1 µm from 100 µm) | accuracy 3% (1% with Offset-Accur) | minimal measuring area 6 mm | minimal base thickness 0.3 mm | incl. base plate, calibration foils and batteries | delivered in a hard carrying case



Art.-Nr. Order no.	Typ type	Prüfobjekt test object	EUR
49-631	F	nicht-magnetische Schichten (z. B. Chrom, Gummi, Lack) auf magnetischen Metallen (z. B. Stahl) <i>non-magnetic coatings (e. g. chrome, rubber, lacquer) on magnetic metals (e. g. steel)</i>	315,00
49-633	N	nicht-magnetische Schichten (z. B. Lack, Farbe, Emaille, Kunststoffe) auf nicht-magnetischen Metallen (z. B. Aluminium, Messing, Blech, Kupfer) <i>non-magnetic coatings (e. g. laquer, paints, enamel, plastics) on non-magnetic metals (e. g. aluminium, brass, sheet metal, copper)</i>	355,00
49-635	FN	Kombination aus Typ F und N <i>combination of type F and N</i>	395,00

SAUTER Materialdickenmessgerät *Material thickness gauge*

zum Messen der Materialdicke von Stahl, Gusseisen, Grauguss, Aluminium, Kupfer, Messing, Zink, Quarzglas, Polyethylen und PVC durch Ultraschall | externer Messkopf Ø8 mm | Messbereich 1,5-200 mm | Auflösung 0,1 mm | Genauigkeit 0,5% von Max. | Batteriebetrieb | inkl. Nullplatte zur Justierung, Ultraschall-Kontaktgel und Batterien | Lieferung im robusten Tragekoffer
to measure the material thickness of steel, cast iron, grey cast iron, aluminium, copper, brass, zinc, quartz glass, polyethylene, PVC via ultrasonic | external sensor Ø8 mm | range 1.5-200 mm | resolution 0.1 mm | accuracy 0.5% of max. | battery operated | incl. base plate for adjustment, ultrasonic contact gel and batteries | delivered in a hard carrying case



Art.-Nr. Order no.	EUR
49-641	205,00

Ultraschall-Kontaktgel, ca. 60 ml:
ultrasonic contact gel, approx. 60 ml:

Art.-Nr. Order no.	EUR
49-649	29,50



Sonstige Messgeräte Other measuring instruments

ACCUD Rauheitsmessgerät *Roughness Tester*

13 Rauheitskennwerte (Ra, Rz, Ry, Rq, Rp, Rm, Rt, R3z, Rmax, Sk, S, Sm, tp) | Messbereich 160 µm | Auflösung (Ra) 0,001 µm | Messlänge einstellbar 0,25/0,8/2,5 mm | Genauigkeit ±10% | induktives Tastsystem mit Diamantspitze (Radius 5 µm/90°) | Messkraft 0,4 mN | Messgeschwindigkeit 0,5 mm/s oder 1 mm/s | inkl. Kalibrierplatte |

Speicher für 100 Messwerte | Einschub für MiniSD-Speicherkarten zum Speichern von Messwerten | Datenausgang über USB-Schnittstelle, inkl. Übertragungskabel und Software | Bedienersprache Englisch | höhenverstellbares Unterlegstück zum Ausgleich verschieden großer Prüflinge | inkl. Akku und Netzteil | Kunststoffkoffer

13 roughness parameters (Ra, Rz, Ry, Rq, Rp, Rm, Rt, R3z, Rmax, Sk, S, Sm, tp) | range 160 µm | resolution (Ra) 0.001 µm | sampling length adjustable 0.25/0.8/2.5 mm | accuracy ±10% | inductive scanning system with diamond stylus (radius 5 µm/90°) | measuring force 0.4 mN | traverse speed 0.5 mm/s or 1 mm/s | incl. calibration block | memory for 100 measuring values | slot for MiniSD card to save measuring values | data output via USB interface, incl. data transfer cable and software | user language English | height adjustable spacer for compensation of different sized test samples | incl. rechargeable battery and power supply | plastics carrying case

ACCUD



Art.-Nr. Order no.	EUR
70-051	1145,00

Zubehör: *Accessories:*

Art.-Nr. Order no.	Typ type	EUR
70-055	Taster-Verlängerung <i>Extension rod</i>	198,00
70-056	höhenverstellbarer Ständer <i>Adjustable stand</i>	785,00

inkl. Software *incl. software*



Ersatzteile: *Spare parts:*

Art.-Nr. Order no.	Typ type	EUR
70-059	Ersatz-Taster <i>Spare part feeler</i>	458,00

Rauheits-Oberflächen-Vergleichsplatten *Roughness surface checking plates*

für Vergleichsprüfungen der Oberflächenbeschaffenheit | Vergleichsbereiche Ra 0,05-12,5 µm / AA 2-500 µAA / ISO N2-N10 | Plattengröße je ca. 22x10 mm
for checking the surface conditions | Range Ra 0,05-12,5 µm / AA 2-500 µAA / ISO N2-N10 | size of plates each approx. 22x10 mm



24-809

Art.-Nr. Order no.	Bearbeitungstyp type of processing	Anzahl Platten number of plates	Ra (µm)	EUR
24-801	Plan schleifen <i>Plan grinding</i>	6	1,6/0,8/0,4/0,2/0,1/0,05	34,50
24-802	Horizontal fräsen <i>Horizont. milling</i>	6	12,5/6,3/3,2/1,6/0,8/0,4	34,50
24-803	Vertikal fräsen <i>Vertical milling</i>	6	12,5/6,3/3,2/1,6/0,8/0,4	34,50
24-804	Drehen <i>Turning</i>	6	12,5/6,3/3,2/1,6/0,8/0,4	34,50
24-805	Runds schleifen <i>External grinding</i>	6	1,6/0,8/0,4/0,2/0,1/0,05	34,50
24-809	Plan schleifen <i>Plan grinding</i> Horizontal fräsen <i>Horizont. milling</i> Vertikal fräsen <i>Vertical milling</i> Drehen <i>Turning</i> Runds schleifen <i>External grinding</i> Plan läppen <i>Plan lapping</i>	30	1,6/0,8/0,4/0,2/0,1/0,05 12,5/6,3/3,2/1,6/0,8/0,4 12,5/6,3/3,2/1,6/0,8/0,4 12,5/6,3/3,2/1,6/0,8/0,4 1,6/0,8/0,4/0,2 0,1/0,05	188,00

Sonstige Messgeräte Other measuring instruments

SAUTER Shore-Härtemessgerät Shore hardness tester

zur Härtebestimmung von Kunststoffen per Eindringungsmessung (Shore A, 0 oder D) | Genauigkeit: 1% des Messbereichs | Materialstärke der Probe min. 4 mm | Datenausgang RS232 | Abmessungen 65x38x162 mm | Batteriebetrieb | robuster Tragekoffer

to measure the hardness of plastics through penetration measurement (Shore A, 0 or D) | Accuracy 1% of measuring range | Material thickness of the sample min. 4 mm | data output RS232 | dimensions 65x38x162 mm | battery operated | hard carrying case



Art.-Nr. Order no.	Härteskala Hardness scale	für Materialien for material	Messbereich Range	Auflösung Resolution	EUR
49-681	Shore A	Gummi, Neopren, Silikon, etc. Rubber, neoprene, silicone, etc.	100 HA	0,1 HA	368,00
49-682	Shore 0	Schaumstoffe, Schwämme Foamed material, sponges	100 HO	0,1 HO	368,00
49-683	Shore D	Kunststoffe, Kunstharz, Epoxid, etc. Plastics, artificial resin, epoxy, etc.	100 HD	0,1 HD	368,00



Shore D



Shore 0



Shore A

Zubehör: Accessories:



49-686

Art.-Nr. Order no.	Bezeichnung description	Prüfgewicht Test weight	EUR
49-684	Datenübertragungskabel inkl. Software data transfer cable incl. software		89,00
49-685*	Prüfstand für Shore A und Shore 0 Test stand for Shore A und Shore 0	1 kg	295,00
49-686*	Prüfstand für Shore D Test stand for Shore D	5 kg	349,00

*manueller Hebelprüfstand für reproduzierbare Härteprüfungen
Säulenlänge 300 mm, Prüftisch Ø75 mm, max. Testobjekthöhe 63 mm

*Lever operated test stand for repeatable hardness testing
Length of column 300 mm, Base plate Ø75 mm, max. test object height 63 mm

SAUTER Shore-Härtevergleichsplatten Shore hardness comparison plates

für Härte-Vergleichsprüfungen Shore A oder Shore D | Aufbewahrungsbox
for hardness comparison measurements Shore A or Shore D | box



49-688



49-689



Art.-Nr. Order no.	Härteskala Hardness scale	Anzahl Platten Number of plates	Genauigkeit Accuracy	EUR
49-688	Shore A	7	±2 HA	93,00
49-689	Shore D	3	±2 HD	73,50

Sonstige Messgeräte Other measuring instruments

SAUTER Shore-Durometer Shore hardness tester

zur Härtebestimmung von Kunststoffen per Eindringungsmessung (Shore A, A0 oder D) | Genauigkeit: 3% des Messbereichs | Maximum-Anzeige durch Schleppzeiger | Materialstärke der Probe min. 4 mm | Abmessungen 60x25x115 mm | Aufbewahrungsbox to measure the hardness of plastics through penetration measurement (Shore A, A0 or D) | Accuracy 3% of measuring range | Maximum readout by trailing pointer | Material thickness of the sample min. 4 mm | dimensions 60x25x115 mm | box



Art.-Nr. Order no.	Härteskala Hardness scale	für Materialien for material	Messbereich Range	Auflösung Resolution	EUR
49-677	Shore A	Gummi, Neopren, Silikon, etc. Rubber, neoprene, silicone, etc.	100 HA	1 HA	99,00
49-678	Shore A0	Schaumstoffe, Schwämme Foamed material, sponges	100 HA0	1 HA0	133,00
49-679	Shore D	Kunststoffe, Kunstharz, Epoxid, etc. Plastics, artificial resin, epoxy, etc.	100 HD	1 HD	138,00

ACCUD Härtemessgerät Hardness tester

7 Härteskalen (HLD, HV, HB, HRC, HRB, HS, MPa) | Auflösung 1 HLD/HV/HB/HS/MPa, 0,1 HRC/HRB | Genauigkeit ± 6 HLD / $\pm 0,6$ HRC | min. Prüflingsgewicht 5 kg (bei direkter Prüfung) / 2 kg (auf fester Unterlage) / 0,1 kg (verbunden mit Grundplatte) | min. Dicke Prüfling 5 mm | min. Fläche Prüfling $\varnothing 22$ mm | max. Rauheit Prüfling $1,6 \mu\text{m}$ (Ra) | großes, beleuchtetes LCD-Display | Durchschnittswertkalkulation | interner Speicher zum Speichern von Messwerten | inkl. massivem Testblock | Bedienersprache Englisch | inkl. kabellosem Drucker und Batterien | Kunststoffkoffer



7 hardness scales (HLD, HV, HB, HRC, HRB, HS, MPa) | resolution 1 HLD/HV/HB/HS/MPa, 0.1 HRC/HRB | accuracy ± 6 HLD / ± 0.6 HRC | min. workpiece weight 5 kg (directly) / 2 kg (on solid support) / 0.1 kg (coupled on large plate) | min. workpiece thickness 5 mm | min. workpiece plain $\varnothing 22$ mm | max. workpiece roughness $1.6 \mu\text{m}$ (Ra) | large LCD-display with backlight | average calculation function | internal memory to save measuring values | incl. solid test block | user language English | incl. wireless printer and batteries | plastics carrying case

Art.-Nr. Order no.	EUR
70-101	618,00



kabelloser Drucker (in Lieferumfang enthalten):
wireless printer (included in shipment)



Sonstige Messgeräte Other measuring instruments

SAUTER Härtemessgerät *Hardness tester*

zur Härtebestimmung von allen metallischen Proben (Gewicht >3 kg, Dicke >8 mm) | Messwertanzeige: Rockwell (HRA, HRB, HRC), Vickers (HV), Shore (HS), Leeb (HL), Brinell (HB) | Messbereich 170-960 HL | Genauigkeit: 1% (bei 800 HLD) | externer Rückprallsensor Typ D | Funktionen: Messwert, Durchschnittswert, Messrichtung, Toleranzbereich definierbar (mit akustischem und optischem Signal) | interner Datenspeicher für 600 Messgruppen mit bis zu 32 Einzelwerten je Gruppe | Datenausgang | kleinster Krümmungsradius des Prüfobjekts (konkav/konvex) 50 mm, mit Aufsatzring zur Stabilisierung (optionales Zubehör) 10 mm | Metallgehäuse | Abmessungen 132x82x31 mm | Batteriebetrieb | robuster Tragekoffer

to measure the hardness of all metallic samples (weight >3 kg, thickness >8 mm) | Measurement value display: Rockwell (HRA, HRB, HRC), Vickers (HV), Shore (HS), Leeb (HL), Brinell (HB) | Range 170-960 HL | Accuracy 1% (at 800 HLD) | external impact sensor type D | Functions: measured result, average value, impact direction, tolerance setting (with audible and visual signal) | internal memory for 600 data groups with up to 32 values per group | data output | minimum sample radius (concave/convex) 50 mm, with support ring (optional accessory) 10 mm | metal housing | dimensions 132x82x31 mm | battery operated | hard carrying case



Art.-Nr. Order no.	EUR
49-690	1228,00

Zubehör:

Accessories:



49-694

Art.-Nr. Order no.	Bezeichnung description	EUR
49-692	Aufsatzringe (zur sicheren Positionierung) Support rings (for secure positioning)	314,00
49-694*	Plug-In für Microsoft Excel® Plug-In for Microsoft Excel®	88,50
49-695	Datenübertragungssoftware Data transfer software	147,00

*zur einfachen Übertragung des internen Speichers an Excel®
For simple transfer of internal memory to Excel®

SAUTER Härte-Prüfblock *Hardness test block*

für Härte-Vergleichsprüfungen | Genauigkeit ±40 HL | Größe ca. Ø90 mm | Gewicht ca. 3 kg
for hardness comparison measurements | Accuracy ±40 HL | size approx. Ø90 mm | weight approx. 3 kg



Art.-Nr. Order no.	Härte Hardness	EUR
49-697	790 HL	187,00
49-698	630 HL	187,00
49-699	530 HL	187,00

Sonstige Messgeräte Other measuring instruments

SAUTER Kraftmessgerät mit Datenausgang Force gauge with data output

für Zug- und Druckkraftmessungen | mit Überlastschutz | Genauigkeit $\pm 0,2\%$ des Messbereichs | Höchstwert- oder Echtzeit-Modus | Toleranzgrenzen einstellbar mit optischem Signal | interner Speicher zum Speichern von 500 Messwerten | Anschlussgewinde M6 (externe Messzelle M12) | Metallgehäuse | inkl. Akku und Netzteil | inkl. Zugösen und Druckplatten | robuster Tragekoffer
for pull and push force measurement | with overload protection | accuracy $\pm 0.2\%$ of full scale | peak or real-time working mode | adjustable tolerance limits with optical signal | internal memory for 500 measuring values | thread M6 (external measuring cell M12) | metal housing | incl. rechargeable battery and power supply | incl. tension loops and compression plates | hard carrying case



*ab 2500 N mit externer Messzelle
from 2500 N with external measuring cell

Art.-Nr. Order no.	Messbereich range	Auflösung resolution	EUR
49-651	5 N	0,002 N	490,00
49-652	10 N	0,005 N	490,00
49-653	25 N	0,01 N	490,00
49-654	50 N	0,02 N	490,00
49-655	100 N	0,05 N	490,00
49-656	250 N	0,1 N	490,00
49-657	500 N	0,2 N	490,00
49-658	1000 N	0,5 N	559,00
49-659*	2500 N	1 N	588,00
49-660*	5000 N	2 N	970,00

Zubehör: Accessories:

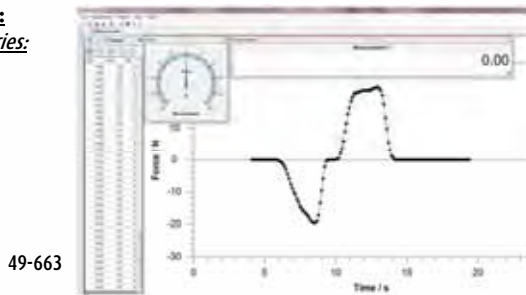

Art.-Nr. Order no.	Bezeichnung description	EUR
49-661	USB-Datenübertragungskabel USB data transfer cable	45,00
49-662	RS232-Datenübertragungskabel RS232 data transfer cable	45,00
49-663	Kraft-Zeit-Datenübertragungssoftware AFH FAST Force-time data transfer software AFH FAST	113,00
49-664	Kraft-Weg-Datenübertragungssoftware AFH FD Force-displacement data transfer software AFH FD	638,00

SAUTER Motorisierter Prüfstand für Kraftmessungen Motorized test stand for force measurements



Messbereich bis 5000 N | Geschwindigkeit 10-230 mm/min | max. Verfahrweg 210 mm | Säulenlänge 635 mm | Steuerung des Prüfstands über Bedienpanel oder Software AFH | kraftgesteuerte Abschaltautomatik | Wiederholfunktion für Dauerbelastungstests | inkl. Längenmessgerät SAUTER LA (ohne Datenausgang) zum Ablesen des Messweges (Auflösung 0,01 mm) | Direktmontage von Messgeräten mit interner Messzelle (für Messgeräte mit externer Messzelle wird Halterung 49-673 benötigt) | Lieferung ohne Kraftmessgerät



Measuring range up to 5000 N | speed 10-230 mm/min | max. travelling distance 210 mm | length of columns 635 mm | control of the test stand with operating panel or via software AFH | force controlled automatic switchoff | repeat function for long-term loading tests | incl. SAUTER LA length measuring device (without data output) to read the travel distance (reading 0.01 mm) | direct installation of measuring devices with internal load cell (for measuring devices with external load cell mount 49-673 is needed) | without force gauge

Art.-Nr. Order no.	EUR
49-671	1970,00

Zubehör: accessories:

Art.-Nr. Order no.	Bezeichnung description	EUR
49-673	Halterung für Kraftmessgeräte mit externer Messzelle Mount for force measuring devices with external sensor	64,00
49-674*	Einbaumessschieber 200 mm / 0,01 mm inkl. Datenausgang Digital scale unit 200 mm / 0.01 mm incl. data output	1190,00

*benötigt für Kraft-Weg-Messungen mit Software AFH FD, inkl. Montage am Prüfstand
required for force-displacement-measurements with software AFH FD incl. mounting onto test stand

Sonstige Messgeräte Other measuring instruments

ACCUD Kraftmessgerät Force gauge

für Zug- und Druckkraftmessungen | mit Überlastschutz | Genauigkeit $\pm 0,3\%$ des Messbereichs | Höchstwert- oder Echtzeit-Modus | Toleranzgrenzen einstellbar | interner Speicher zum Speichern von 1000 Messwerten | Bediener-sprache Englisch, Menüsprache auf Deutsch umstellbar | inkl. Software für PC | inkl. Akku und Netzteil | mit verschiedenen Zug-/Druckadptern | Kunststoffbox

for pull and push force measurement | with overload protection | accuracy $\pm 0.3\%$ of full scale | peak or real-time working mode | tolerance limits adjustable | internal memory to save 1000 measuring values | user language English, menu switchable to German language | incl. software for PC | incl. rechargeable battery and power supply | incl. different pull/push clamps | plastics box

ACCUD



70-202

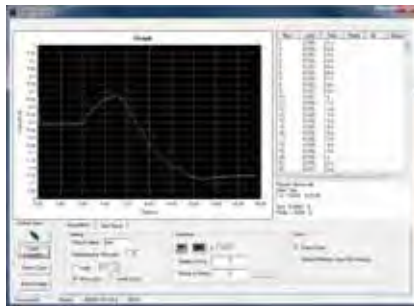

inkl. Software *incl. software*

Art.-Nr. Order no.	Messbereich Range	Auflösung Resolution	EUR
70-201	10 N	0,001 N	349,00
70-202	20 N	0,005 N	349,00
70-203	50 N		349,00
70-204	100 N	0,01 N	349,00
70-205	200 N		349,00
70-206	500 N	0,05 N	399,00
70-207	1000 N	0,1 N	399,00

Zubehör *accessories:*



70-219

Art.-Nr. Order no.	Typ Type	EUR
70-219*	Ständer Stand	395,00

*Zugkraft max. 650 N / Druckkraft max. 1200 N, max. Hub 230 mm
Pull force max. 650 N / push force max. 1200 N, max. travel 230 mm

ACCUD Drehmomentmessgerät Torque meter

zum Kalibrieren von Drehmomentschlüsseln | Nm/cNm/kgf.cm/lbf.cm/lbf.in | Genauigkeit $\pm 0,5\%$ des Messbereichs | Höchstwert-, Preset- (Voreinstellwert) oder Echtzeit-Modus | Vierkant-Aufnahme $\frac{1}{2}$ " | interner Speicher zum Speichern von 1500 Messwerten | Bediener-sprache Englisch, Menüsprache auf Deutsch umstellbar | inkl. Software für PC | Datenausgang USB/RS232 | inkl. Akku und Netzteil | Abmessungen 197x180 mm | Gewicht 1,5 kg | Kunststoffbox

for torque screwdriver calibration | Nm/cNm/kgf.cm/lbf.cm/lbf.in | accuracy $\pm 0.5\%$ of full scale | peak, preset or real-time working mode | size of square drive $\frac{1}{2}$ " | internal memory to save 1500 measuring values | user language English, menu switchable to German language | incl. software for PC | data output USB/RS232 | incl. rechargeable battery and power supply | dimensions 197x180 mm | weight 1.5 kg | plastics box

ACCUD



70-302

Art.-Nr. Order no.	Messbereich Range	Auflösung Resolution	EUR
70-301	5 Nm	0,001 Nm	990,00
70-302	10 Nm	0,01 Nm	1179,00
70-303	50 Nm		1485,00
70-304	100 Nm	0,1 Nm	1679,00

Sonstige Messgeräte Other measuring instruments

SAUTER Drehmomentmessgerät Torque meter

zur Prüfung von Drehmomentschlüsseln, Elektro-Handschaubendreher und Akkuschraubern | mit Überlastschutz | Genauigkeit $\pm 0,5\%$ des Messbereichs | Höchstwert- oder Echtzeit-Modus | in beide Drehrichtungen verwendbar | Toleranzgrenzen einstellbar mit akustischem und optischem Signal | interner Speicher zum Speichern von 500 Messwerten | Datenausgang USB und RS232 | Metallgehäuse | Gummi-FüÙe mit Anti-Rutsch-Funktion (bis 10 Nm), stabile Montageplatte zur soliden Befestigung (ab 20 Nm) | Abmessungen 200x100x50 mm | inkl. Akku und Netzteil | robuster Tragekoffer

for testing torque wrenches, electric hand screwdrivers and cordless screwdrivers | with overload protection | Accuracy $\pm 0.5\%$ of full scale | peak or real-time working mode | can be used in both directions of rotation | tolerance limits adjustable with audible and visual signal | internal memory to save 500 measuring values | data interface USB and RS232 | metal housing | Rubber feet with anti-slip feature (up to 10 Nm), stable mounting plate for solid fixation (from 20 Nm) | Dimensions 200x100x50 mm | incl. rechargeable battery and power supply | hard carrying case



49-623



ab 20 Nm inkl. stabiler Montageplatte
from 20 Nm incl. stable mounting plate

Art.-Nr. Order no.	Messbereich Range	Auflösung Resolution	Werkzeugaufnahme Tool fitting	EUR
49-621	0,5 Nm	0,0001 Nm	20 mm und and 3/8"	1460,00
49-622	1 Nm	0,0002 Nm		1460,00
49-623	5 Nm	0,001 Nm		1460,00
49-624	10 Nm	0,002 Nm		1460,00
49-625	20 Nm	0,005 Nm		1655,00
49-626	50 Nm	0,01 Nm		1655,00
49-627	100 Nm	0,02 Nm	3/8"	1655,00
49-628	200 Nm	0,05 Nm	1/2"	1655,00
49-629	500 Nm		3/4"	1655,00



bis 50 Nm inkl. Drehaufnehmer-System
zur dynamischen Prüfung von Elektro-Schraubern
up to 50 Nm incl. torque pick-up system
for dynamic testing of electric screwdrivers

Zubehör: Accessories:

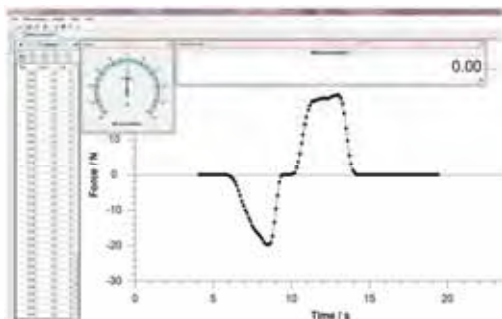

49-663

Art.-Nr. Order no.	Bezeichnung description	EUR
49-661	USB-Datenübertragungskabel USB data transfer cable	45,00
49-662	RS232-Datenübertragungskabel RS232 data transfer cable	45,00
49-663	Kraft-Zeit-Datenübertragungssoftware AFH FAST Force-time data transfer software AFH FAST	113,00



49-661



49-662

Sonstige Messgeräte Other measuring instruments

ACCUD Digital-Thermometer *Digital thermometer*



Messbereich -20°C bis +60°C | Auflösung 0,1°C | Genauigkeit ±1% | inkl. Luftfeuchtigkeits- und Uhrzeit-Anzeige | Abmessung ca. 98x106x20 mm | nur für Innenbereiche geeignet | Batteriebetrieb

Range -20°C to +60°C | resolution 0.1°C | accuracy ±1% | incl. display of humidity and time | dimensions approx. 98x106x20 mm | indoor use only | battery operated

ACCUD

Art.-Nr. Order no.	EUR
70-090	11,50

LUFFT Digital-Thermometer mit Datenaufzeichnung *Digital thermometer with data recording*

Messbereich -20°C bis +50°C | Auflösung 0,1°C | Genauigkeit ±0,3°C (im Bereich 0...40°C) | inkl. Luftfeuchtigkeits-, Datum- und Uhrzeit-Anzeige | Datenspeicher für 3.200.000 Messwerte | Speicherintervall einstellbar von 1 min bis 24 h | Schnittstelle USB, LAN | Software SmartGraph 3 (für Windows) zur grafischen und numerischen Darstellung der Messauswertung | Abmessung ca. 166x78x32 mm | Batteriebetrieb (optional mit Netzteil) | Lieferung inkl. Software, Datenkabel, Batterien und Halterung

Range -20°C to +50°C | Resolution 0.1°C | Accuracy ±0.3°C (within 0...40°C) | incl. display of humidity, date and time | Memory for 3,200,000 measuring values | Saving interval adjustable from 1 min to 24 h | Interface USB, LAN | Software SmartGraph 3 (for Windows) for graphic and numeric display of measuring values | dimensions approx. 166x78x32 mm | battery operated (optional with power supply) | incl. software, data cable, batteries and holder

Lufft



Art.-Nr. Order no.	PoE (Power over Ethernet) Stromversorgung über LAN	EUR
49-301	-	385,00
49-302	ja yes	549,00

Zubehör: Accessories:	Art.-Nr. Order no.	Bezeichnung description	EUR
	49-331	Netzteil 230 V Power supply 230 V	29,50

LUFFT Dig.-Thermometer mit Datenaufzeichnung & externen Sensoren *Dig. thermometer with data recording & external sensors*

Messbereich 0°C bis +50°C | Auflösung 0,1°C | Genauigkeit ±0,2°C (im Bereich 0...40°C) | inkl. Luftfeuchtigkeits-, Datum- und Uhrzeit-Anzeige | Datenspeicher für 3.200.000 Messwerte | Speicherintervall einstellbar von 1 min bis 24 h | max. 4 externe Sensoren | Schnittstelle USB, LAN, RS 485 | Software SmartGraph 3 (für Windows) zur grafischen und numerischen Darstellung der Messauswertung | Abmessung ca. 180x78x32 mm | Batteriebetrieb (optional mit Netzteil) | Lieferung inkl. Software, Datenkabel, Batterien und Halterung

Range 0°C to +50°C | Resolution 0.1°C | Accuracy ±0.2°C (within 0...40°C) | incl. display of humidity, date and time | Memory for 3,200,000 measuring values | Saving interval adjustable from 1 min to 24 h | max. 4 external sensors | Interface USB, LAN, RS 485 | Software SmartGraph 3 (for Windows) for graphic and numeric display of measuring values | dimensions approx. 180x78x32 mm | battery operated (optional with power supply) | incl. software, data cable, batteries and holder

Lufft



Zubehör: Accessories:	Art.-Nr. Order no.	Bezeichnung description	EUR
	49-321	Sensor Temperatur/Feuchte Probe temperatue/humidity	226,00
	49-333	Verbindungskabel 2 m Connection cable 2 m	34,50
	49-334	Verbindungskabel 10 m Connection cable 10 m	67,50
	49-335	Verbindungskabel 25 m Connection cable 25 m	107,00
	49-338*	Zweifachverteiler Y Splitter Y	28,50
	49-331	Netzteil 230 V Power supply 230 V	29,50

Grundgerät (ohne Sensor):
Basic device (without sensor):

Art.-Nr. Order no.	PoE (Power over Ethernet) Stromversorgung über LAN	EUR
49-311	-	495,00
49-312	ja yes	659,00

*erforderlich beim Einsatz von mehr als einem Sensor
necessary when using more than one sensor

Sonstige Messgeräte Other measuring instruments

ACCUD Infrarot-Thermometer *Infrared Thermometer*



Messbereich -50°C bis +700°C | Auflösung 0,1°C | Genauigkeit ±1,5% oder ±1,5°C | Messzeit 0,5 s | Verhältnis Entfernung/Messpunkt 12:1 | Batteriebetrieb
Range -50°C to +700°C | resolution 0.1°C | accuracy ±1.5% or ±1.5°C | response time 0.5 sec | distance spot ratio 12:1 | battery operated

ACCUD

Art.-Nr. Order no.	EUR
70-091	58,00

VOGEL Präzisions-Stoppuhr *Precision stop watch*



Mechanische Stoppuhr mit Metallgehäuse | stoß-, staub- und wassergeschützt (IP54) | Anzeigebereich 30 Min. | Ablesung 0,2 s | Gehäuse Ø55 mm | Made in Germany
Mechanical stop watch with metal housing | shock-, dust- and waterproof (IP54) | range 30 min. | reading 0.2 sec | housing Ø55 mm | Made in Germany

VOGEL
GERMANY

Art.-Nr. Order no.	EUR
44-302	189,00

VOGEL Digital-Stoppuhr *Digital stop watch*



Robustes Kunststoffgehäuse | wassergeschützt (IP54) | Anzeigebereich 9 h 59 Min. | Ablesung 0,01 s | vielfältige Funktionen (Start/Stop/Reset-Addition/Split/Lap/Normalzeit) | interner Speicher für 25 Split-/Rundenzeiten | Abmessungen 82x61x28 mm | inkl. Umhängekordel, Schutztasche und Bedienungsanleitung | Made in Germany

Robust plastics housing | waterproof (IP54) | range 9 h 59 min. | reading 0.01 sec | multiple functions (Start/Stop/Reset-Addition/Split/Lap/standard time) | internal memory for 25 split-/lap-times | dimensions 82x61x28 mm | incl. shoulder cord, bag and operation manual | Made in Germany

VOGEL
GERMANY

Art.-Nr. Order no.	EUR
44-312	49,00

01



02



03



04



05



06



07



08



09



10



11



12



13



14



15



Sonstige Messgeräte Other measuring instruments

ACCUD Digital-Drehzahlmessgerät *Digital rotation speed counter*

Messbereich 2,5 - 99.999 U/min | Auflösung 0,1 U/min (bis 1000 U/min) / 1 U/min (ab 1000 U/min) | Genauigkeit $\pm(1\% + 5d)$ | Mess-Abstand (d) 50-500 mm | Echtzeit-/Max-/Min-/Durchschnitts-Modus | Batteriebetrieb
Range 2.5 - 99,999 rpm | resolution 0.1 rpm (up to 1000 rpm) / 1 rpm (from 1000 rpm) | accuracy $\pm(1\% + 5d)$ $\pm 1.5^\circ\text{C}$ | measuring distance (d) 50-500 mm | Real-time/Max/Min/Average measuring mode | battery operated

ACCUD



Art.-Nr. Order no.	EUR
70-095	37,80

SAUTER Lichtmessgerät *Light measuring instrument*

Messbereich bis 200.000 Lux | wählbare Einheiten: lx (Lux) / fc (foot-candle) | Kosinus-Korrektur für schräg einfallendes Licht | TRACK-Funktion zur kontinuierlichen Aufzeichnung wechselnder Umgebungsbedingungen | PEAK-Funktion zur Erfassung des Spitzenwertes | Kabellänge (Photo-Sensor) ca. 1 m | Aufbewahrungsbox

Range up to 200,000 Lux | selectable measuring units: lx (Lux) / fc (foot-candle) | Cosine correction for angular incident light | TRACK function for continuous recording of variable environmental conditions | PEAK mode to capture peaks | cable length (photo sensor) approx. 1 m | box

SAUTER



Art.-Nr. Order no.	EUR
49-601	83,50

SAUTER Schallpegelmessgerät *Sound level meter*

für Lärmmessungen bis 130 dB | TRACK-Funktion zur kontinuierlichen Aufzeichnung wechselnder Umgebungsbedingungen | PEAK-Funktion zur Erfassung des Spitzenwertes | interner Messwertspeicher für 30 Messungen | RS232-Schnittstelle | Batteriebetrieb | Tragekoffer

for measuring noise up to 130 dB | TRACK function for continuous recording of variable environmental conditions | PEAK mode to capture peaks | internal memory for 30 measured values | RS232 interface | battery operated | carrying case

SAUTER



Art.-Nr. Order no.	EUR
49-611	108,00

Zubehör, Kalibrierung, allgemeine Informationen

Accessories, calibration, general information



Inhalt Contents



15.2



15.4



15.5



15.6



15.7



15.8

Stichtestschein	
Abkürzungen	014
Abkürzungen Sachverhalte	027
Abkürzungen Sachverhalte (Tabelle)	037
Abkürzungen	041
Abkürzungen	023
Abkürzungen Sachverhalte	034
Abkürzungen Sachverhalte	040
Abkürzungen	043
Abkürzungen	049

15.16

Zubehör, Kalibrierung, allgemeine Informationen Accessories, calibration, general information

Zubehör für Datenübertragung RB5 Accessories for data transfer RB5

für alle Messgeräte mit Datenausgang RB5 | am Messgerät angezeigter Messwert wird einfach per Tastendruck an einen PC (Windows 10) übertragen und direkt in ein Messprotokoll, CAQ-System, Excel-Tabelle o. ä. eingefügt | verschiedene Optionen einstellbar | Auflösung 0,01 mm

For all measuring devices with data output RB5 | displayed value from measuring device is simply transferred by keystroke to a PC (Windows 10) into a measurement report, CAQ-system or Excel table, etc. | various options adjustable | resolution 0.01 mm



Art.-Nr. Order no.	Artikel Range	EUR
10-981	USB-Interface (2,4 m)	108,00
10-991	Anschlußkabel RB5 (1 m) Connection cable RB5	13,50

HELIOS-PREISSER Datenübertragungskabel für variablen Datenausgang Data transfer cable for variable data output

für alle HELIOS-PREISSER Messgeräte mit variablem Datenausgang | Länge 2 m | mit Datenübertragungstaste | Software „MarCom Professional“ für Windows 7/8/10 zum Übertragen der Messwerte in Anwendungen kostenlos downloadbar auf www.helios-preisser.de

For all HELIOS-PREISSER measuring tools with variable data output | length 2 m | with data transfer button | software „MarCom Professional“ for Windows 7/8/10 for transferring measuring values into applications free download at www.helios-preisser.de





Art.-Nr. Order no.	Schnittstelle Interface	EUR
46-091	USB	69,50
46-092	RS232	49,00
46-093	Digimatic	62,50

HELIOS-PREISSER Datenübertragungskabel Proximity-USB Data transfer cable Proximity-USB

für alle HELIOS-PREISSER Messgeräte mit Datenausgang Proximity-USB | Länge 2 m | mit Datenübertragungstaste | Software „MarCom Professional“ für Windows 7/8/10 zum Übertragen der Messwerte in Anwendungen kostenlos downloadbar auf www.helios-preisser.de

For all HELIOS-PREISSER measuring tools with data output Proximity-USB | length 2 m | with data transfer button | software „MarCom Professional“ for Windows 7/8/10 for transferring measuring values into applications free download at www.helios-preisser.de

Art.-Nr. Order no.	Schnittstelle Interface	EUR
46-195	USB	144,00

HELIOS-PREISSER USB-Empfänger für Funk-Datenübertragung USB receiver for wireless data transfer

für bis zu 8 HELIOS-PREISSER Messgeräte mit „Integrated Wireless“ | Funkdistanz bis zu 6 m | USB-Anschluss | Software „MarCom Professional“ für Windows 7/8/10 zum Übertragen der Messwerte in Anwendungen kostenlos downloadbar auf www.helios-preisser.de

For up to 8 HELIOS-PREISSER measuring tools with „Integrated Wireless“ | radio distance up to 6 m | USB interface | software „MarCom Professional“ for Windows 7/8/10 for transferring measuring values into applications free download at www.helios-preisser.de





Art.-Nr. Order no.	EUR
46-099	93,50

Software „MarCom Professional“ für Windows:
(kostenlos downloadbar auf www.helios-preisser.de)
software „MarCom Professional“ for Windows
(free download at www.helios-preisser.de)

Datenübertragung mit mehreren Messgeräten

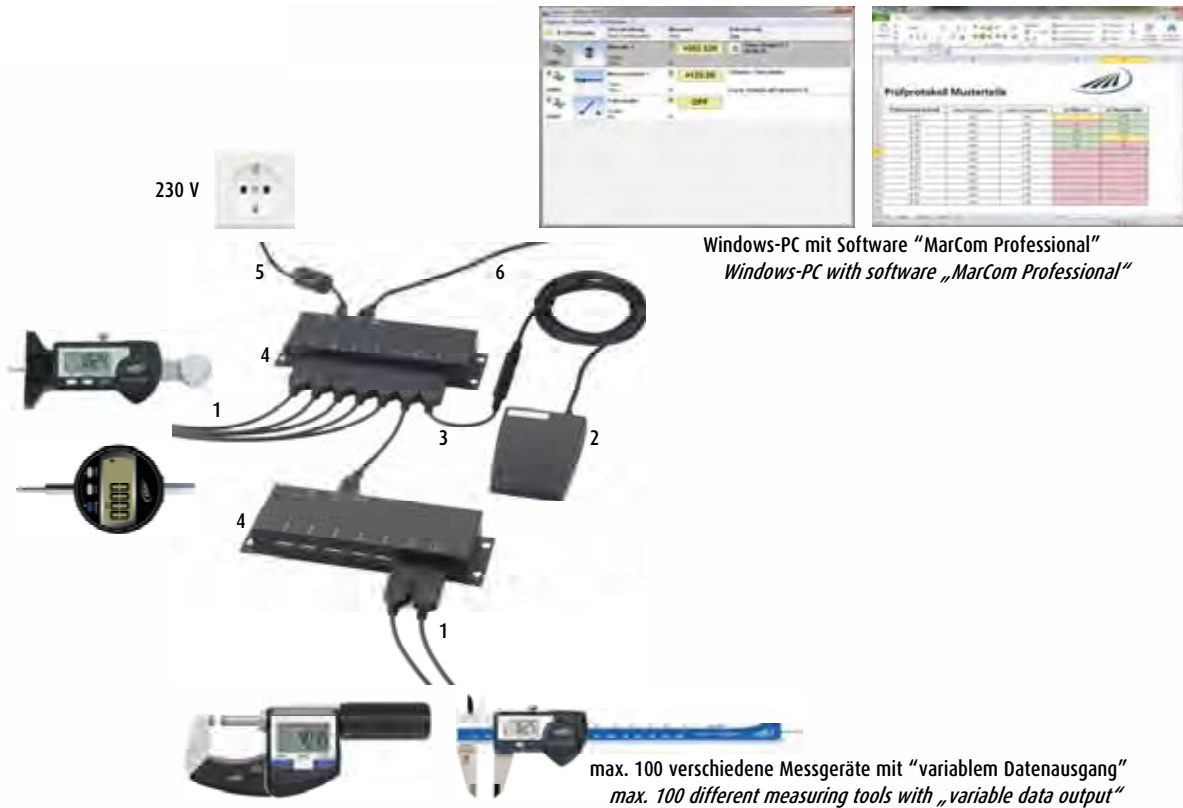
für einen Messplatz mit mehreren Messgeräten, welche die Messergebnisse an einen PC mit Windows 7/10 übertragen sollen
for a measuring workstation with several measuring tools, which are to transfer measuring results to a PC with Windows 7/10



Windows-PC mit Software "MarCom Professional"
Windows-PC with software „MarCom Professional“

max. 100 verschiedene Messgeräte mit "variablen Datenausgang"
max. 100 different measuring tools with „variable data output“

Erläuterung zur Abbildung:

- 1 USB-Datenkabel zu den einzelnen Messgeräten
- 2 Fußschalter
- 3 USB-Adapterkabel für Fußschalter
- 4 USB-Hub 7fach
- 5 Stromversorgung USB-Hub
- 6 PC-Anschluß (USB)

Explanation of the illustration:

- 1 USB data cable to the different measuring tools
- 2 foot switch
- 3 USB adaptor cable for foot switch
- 4 USB-hub with 7 ports
- 5 power supply USB hub
- 6 PC connection (USB)

Art.-Nr. Order no.	Komponente component	Abb. fig.	EUR
46-091	USB-Datenkabel „variabler Datenausgang“ USB data cable „variable data output“	1	69,50
50-902	Fußschalter foot switch	2	29,00
46-097	Adapterkabel Fußschalter adaptor cable foot switch	3	58,50
46-098	USB-Hub 7fach 7 ports	4	69,00

wählbare Komponenten:

- Software „MarCom Professional“ für über 100 Messgeräte mit USB-Datenkabel und max. 2 Messgeräte über COM-Schnittstelle
Messwertübernahme direkt in Excel (ab Version 97), per Textdatei, Tastaturcode oder virtuelle Interfacebox MUX50 Format
(kostenlos downloadbar auf www.helios-preisser.de)
- USB-Datenkabel (je 1x für alle Helios-Preisser Messgeräte mit variablem Datenausgang)
- Fußschalter (mehrere Fußschalter anschließbar und den Messgeräten frei zuordenbar)
- USB-Adapterkabel für Fußschalter (wird zwingend je 1x pro Fußschalter benötigt)
- USB-Hub 7fach für bis zu 7 Messgeräte oder Fußschalter, inkl. Netzgerät

selectable components:

- software "MarCom Professional" for more than 100 measuring tools with USB data cable and max. 2 measuring tools via COM interface
measuring result transfer direct into Excel, via text file, keyboard code or virtual interface box MUX50 format
(free download at www.helios-preisser.de)
- USB data cable (1 for every Helios-Preisser measuring tool with variable data output)
- foot switch (several foot switches suitable for connection and user-defined assignable to the measuring tools)
- USB adaptor cable for foot switch (mandatory for each foot switch)
- USB hub with 7 ports for up to 7 measuring tools or foot switches, incl. power supply



Zubehör, Kalibrierung, allgemeine Informationen Accessories, calibration, general information

SYLVAC Datenübertragungskabel „Proximity“ Data transfer cable „Proximity“

für alle SYLVAC Messgeräte mit Datenausgang „Proximity“ | Länge 3 m | PC-Schnittstelle nach Wahl: USB oder RS232 (bei USB-Variante inkl. Software zur Datenübertragung auf einen PC mit Windows 7/10)
for all SYLVAC measuring tools with data output „Proximity“ | length 3 m | PC interface selectable: USB or RS232 (USB-variant incl. software for data transfer to a PC with Windows 7/10)

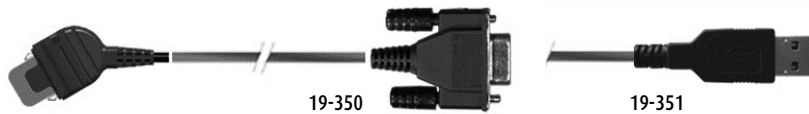

Art.-Nr. Order no.	Schnittstelle interface	EUR
19-350	RS232	83,50
19-351	USB	83,50



Software „SylConnect LIGHT“ (enthalten bei included with 19-351)

SYLVAC USB-Datenübertragungskabel „Power“ USB data transfer cable „Power“

für alle SYLVAC Messgeräte mit Datenausgang „Power“ | Länge 3 m | PC-Schnittstelle: USB | inkl. Software „SylConnect LIGHT“ (siehe oben) zur Datenübertragung auf einen PC mit Windows 7/10
for all SYLVAC measuring tools with data output „Power“ | length 3 m | PC interface: USB incl. software „SylConnect LIGHT“ (see above) for data transfer to a PC with Windows 7/10



Art.-Nr. Order no.	EUR
19-361	149,00

SYLVAC USB-Dongle Bluetooth® USB dongle Bluetooth®



für bis zu 8 SYLVAC-Messgeräte mit Bluetooth-Datenausgang | USB-Empfangseinheit für Windows 10 | automatische Erkennung der Messgeräte | inkl. Software „Vmux“

for up to 8 SYLVAC measuring tools with Bluetooth data output | USB receiver for Windows | automatic detection of measuring tools | incl. Software „Vmux“



Art.-Nr. Order no.	EUR
19-399	79,50

Batterien Batteries

Alle unsere batteriebetriebenen Messgeräte werden inklusive Batterie ausgeliefert. Ersatzbatterien finden Sie hier:
All our battery operated measuring tools are delivered inclusive battery. Spare batteries are found here:



Art.-Nr. Order no.	Bezeichnung type	Spannung voltage	Abmessungen dimensions	EUR
10-099	LR44	1,5 V	Ø11,6x5,4 mm	0,85
02-1032	CR1632	3 V	Ø16x3,2 mm	0,85
02-1031	CR2032	3 V	Ø20x3,2 mm	0,85

Weitere Batterien auf Anfrage!
Further batteries on request!



Bitte beachten Sie die für Ihr Land gültigen gesetzlichen Vorschriften zur Entsorgung von Altbatterien!
Please follow the legal directives for disposal of used batteries that are valid in your country!

Zubehör, Kalibrierung, allgemeine Informationen Accessories, calibration, general information

VOGEL Reinigungsmittel für Messwerkzeuge *Detergent for measuring tools*



reinigt, pflegt und schmiert Messwerkzeuge | konserviert entfettete Teile wie Stahl-Endmaße und Prüfstifte | Sprühdose 500 ml | säure- und harzfrei | FCKW-frei | Made in Germany
for cleaning, maintaining and lubrication of measuring tools | conserves degreased parts like steel gauge blocks and pin gauges | aerosol spray 500 ml | acid-free and non-resinous | without CFC | Made in Germany



Art.-Nr. Order no.	EUR
44-499	21,90



Das Sicherheitsdatenblatt zu diesen Produkten können Sie auf www.quality-tools.de im Bereich „Downloads“ herunterladen!
The safety data sheet of these products can be downloaded from www.quality-tools.de on the side "Downloads"!

HELIOS-PREISSER Endmaß-Pflege-Set *Gauge block maintenance set*



6teiliges Set | Holzkasten
Set of 6 pieces | wooden box



Inhalt:	Content:
-Leinenlappen	-linen cloth
-Wildledertuch	-buckskin cloth
-Korrosionsschutzöl	-anti-corrosive oil
-Abziehstein	-whetstone
-Haarpinsel	-hair pencil
-Fettpinsel	-fat brush
-Gebrauchsanweisung	-instruction manual

Art.-Nr. Order no.	EUR
47-600	298,00

Reinigungsmittel für Hartgesteinsprodukte *Cleaning compound for hard stone products*



NOVALINE: spezielles Reinigungsmittel zur schonenden Reinigung von Hartgestein-Produkten | umweltverträglich und wasserlöslich
NOVALINE: special cleaning compound for gentle cleaning of hard stone products | environment friendly and water soluble

48-191



48-195

Art.-Nr. Order no.	Menge quantity	Typ type	EUR
48-191	0,5 l	Sprühflasche, nachfüllbar aerosol can, refillable	9,50
48-192	5 l	Kunststoffkanister plastic canister	79,50

NOVAFLIES: flusenfreies Mikrofasertuch für die schonende Reinigung von Hartgestein | Größe 40x40 cm | besondere Saugfähigkeit | waschbar (bis 60°C) | scheuerfest
NOVAFLIES: lint-free microfiber fabric for gentle cleaning of hard stone | size 40x40 cm | unique absorptive capacity | washable (up to 60°C) | high abrasion resistance

Art.-Nr. Order no.	EUR
48-195	4,90

KERN Reinigungs-Set für Mikroskope *Cleaning set for microscopes*



7teiliges Set für die optimale Pflege Ihres Mikroskops | auch geeignet für andere optische Geräte wie Kameras, Ferngläser, Lupen, etc.

Set of 7 pieces for optimal cleaning of your microscope | also suitable for other optical instruments like cameras, telescopes, loupes, etc.



Inhalt:	Content:
-Hand-Blasebalg	-manual bellows
-Staubpinsel	-dust brush
-Reinigungsflüssigkeit (60 ml)	-detergent (60 ml)
-fusselfreies Staubtuch	-lint-free duster
-optische Reinigungstücher	-optical cleaning tissue
-Reinigungsstäbchen	-cleaning sticks
-Aufbewahrungstasche	-storage bag

Art.-Nr. Order no.	EUR
49-599	24,80

Zubehör, Kalibrierung, allgemeine Informationen Accessories, calibration, general information

HELIOS-PREISSER Gewinde- und Passungsdatenschieber Slider for thread and tolerance data

zum Ablesen der wichtigsten theoretischen Maße für Gewinde bzw. ISO-Passungstoleranzen | Made in Germany
For reading of important data of threads or ISO tolerances (only German language available) | Made in Germany



46-991

Art.-Nr. Order no.	Beschreibung description	Material material	EUR
46-991	M Regelgewinde, G Whitworth-Gewinde <i>M metric standard thread, G Whitworth thread</i>	Aluminium eloxiert <i>Aluminium anodized</i>	14,50
46-992	M Feingewinde (M1x0,2 bis M420x8) <i>M metric fine thread (M1x0.2 to M420x8)</i>		21,00
46-993	ISO-Passungen Welle/Bohrung (Ø1 bis Ø160 mm, A11 bis S7, a11 bis s6) <i>ISO tolerances shaft/hole</i> (Ø1 to Ø160 mm, A11 to S7, a11 to s6)	Kunststoff <i>plastics</i>	19,50
46-994	M Regelgewinde, G Whitworth-Gewinde <i>M metric standard thread, G Whitworth thread</i>		9,90
46-995	ISO-Passungen Welle/Bohrung (Ø1 bis Ø160 mm, A11 bis S7, a11 bis s6) <i>ISO tolerances shaft/hole</i> (Ø1 to Ø160 mm, A11 to S7, a11 to s6)	8,90	

HELIOS-PREISSER Gewinde-, Toleranz- und Umrechnungsanzeiger Indicator for thread, tolerance and conversion data

zum Ablesen der wichtigsten Werte von Gewinden (metrische Regel- und Feingewinde, amerikanische UNC-, UNF-, UNEF- und andere Gewinde), ISO-Toleranzwerte (Welle/Bohrung) und Zoll-Millimeter-Umrechnung | Kunststoffgehäuse
For reading of important data of threads (metric standard and fine, UNC, UNF, UNEF and other threads), ISO tolerances (shaft/hole) and Inch-Millimeter-Conversion | plastics housing

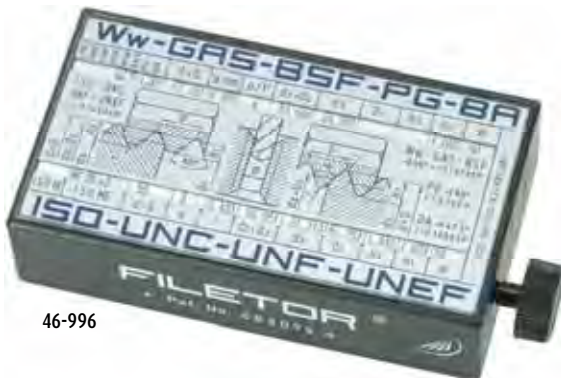

46-996



46-997



46-998

Art.-Nr. Order no.	Typ type	Beschreibung description	EUR
46-996	Filetor	Gewindeanzeiger <i>Indicator for threads</i>	64,50
46-997	Tolerator	ISO-Toleranzanzeiger <i>Indicator for ISO tolerances</i>	64,50
46-998	Convertor	Umrechner Zoll-Millimeter <i>Indicator Inch-Millimetre conversion</i>	64,50

Zubehör, Kalibrierung, allgemeine Informationen Accessories, calibration, general information

Prüfplaketten Ø10 mm *Inspection plates Ø10 mm*

Einjahresprüfplaketten | Größe Ø10 mm | Folie, selbstklebend | Made in Germany | 1 VE = 50 Stück
One year inspection plates | size Ø10 mm | self-adhesive foil | Made in Germany | 1 packing unit = 50 pieces



49-401-21



49-401-22



49-401-23



49-401-24

Art.-Nr. Order no.	Jahr year	Farbe colour	EUR
49-401-21	2021	gelb <i>yellow</i>	4,80
49-401-22	2022	rot <i>red</i>	4,80
49-401-23	2023	blau <i>blue</i>	4,80
49-401-24	2024	grün <i>green</i>	4,80

Prüfplakette Ø30 mm *Inspection plates Ø30 mm*

Mehrfjahresprüfplakette | Größe Ø30 mm | Folie, selbstklebend | Aufdruck „Nächster Prüftermin“ | Made in Germany | 1 VE = 48 Stück
Multi years inspection plate | size Ø30 mm | self-adhesive foil | Inscription "Nächster Prüftermin" | Made in Germany | 1 packing unit = 48 pieces



Andere Ausführungen auf Anfrage!
Other variants on request!

Art.-Nr. Order no.	Jahre years	Farbe colour	EUR
49-405-20	2020-2025	grün <i>green</i>	6,80

Lochzange *Hole punch*

zum Lochen von Prüfplaketten | vernickeltes Metall | Maultiefe 48 mm | Abmessung ca. 140x55x10 mm | Made in Germany
for punching of inspection plates | nickel plated metal | jaw depth 48 mm | dimensions approx. 140x55x10 mm | Made in Germany



Art.-Nr. Order no.	Lochform hole shape	für Prüfplaketten for inspection plates	EUR
49-441	Kreis <i>circle</i> Ø2 mm	Ø10 mm	44,90
49-443	Dreieck <i>triangle</i> 4 mm	Ø30 mm	46,90

Plakettenentferner *Label scraper*

Etikettenschaber zum Entfernen von Prüfplaketten o. ä. | Kunststoff | TÜV-geprüft
Label scraper to remove inspection plates etc. | plastics | certified by "TÜV"



49-451



49-452

Ersatzklingen (10er-Pack):
spare blades (pack of 10):

Art.-Nr. Order no.	EUR
49-451	6,50
Art.-Nr. Order no.	EUR
49-452	6,80

QM-Aufkleber *Labels for quality management*

verschiedene Anwendungsmöglichkeiten | Folie, selbstklebend | Made in Germany | 1 VE = 100 Stück (bei 49-425: 1 VE = 75 Stück)
Different utilisations | self-adhesive foil | Made in Germany | 1 packing unit = 100 pieces (49-425: 1 packing unit = 75 pieces)



49-421



49-425



49-431

Art.-Nr. Order no.	Text text	Größe size	Eigenschaften characteristics	EUR
49-421	Gesperrt	38x23 mm	ablösbar <i>removable</i>	11,80
49-425	unterliegt nicht der PMÜ	Ø10 mm	selbstzerstörend beim Ablösen <i>self-destroying at removing</i>	6,30
49-431	Eigentum von	38x23 mm	ablösbar <i>removable</i>	11,80

Andere Ausführungen auf Anfrage!
Other variants on request!

Zubehör, Kalibrierung, allgemeine Informationen

Accessories, calibration, general information

Kalibrierung Calibration

Alle bei uns erworbenen Messmittel können mit Kalibrierschein geliefert werden. Die Kalibrierung erfolgt durch ein deutsches, nach DIN EN ISO 17025 akkreditiertes Labor unserer Wahl nach den gültigen DIN-Normen, bzw. nach den angegebenen Genauigkeiten (Werknorm) inklusive Kalibrierzertifikat. Die Lieferzeit verlängert sich dadurch in der Regel um ca. 1-2 Wochen! Wir bieten wahlweise Standard-ISO-Kalibrierungen oder DAkks-Kalibrierungen (bei erhöhten Anforderungen, z. B. IATF 16949) an. Weitere Messmittel auf Anfrage!

All measuring tools bought from us can be delivered with a calibration certificate. The calibration is carried out by a German laboratory, which is accredited by DIN EN ISO 17025, according to the effective DIN norms, respectively according to the stated accuracies (factory standard) including calibration certificate. Thereby delivery time increases as a general rule approximately 1-2 weeks.

We offer standard ISO calibrations or alternatively DAkks calibrations (for higher standards, e. g. IATF 16949). Further measuring tools on request!



Deutsche Akkreditierungsstelle GmbH

Befehlens gemäß § 8 Absatz 1 AkkStelleG i.V.m. § 1 Absatz 1 AkkStelleGBV
Unterzeichnerin der Multilateralen Abkommen
von EA, ILAC und IAF zur gegenseitigen Anerkennung

Akkreditierung



Die Deutsche Akkreditierungsstelle GmbH bestätigt hiermit, dass das Kalibrierlaboratorium



die Kompetenz nach DIN EN ISO/IEC 17025:2005 besitzt, Kalibrierungen
in den folgenden Bereichen durchzuführen:













DM107
D-K-
20317-01-00
2017-07

Kapitel chapter	Messmittel measuring tool	Messbereich/Typ Range/type	ISO-Kalibrierung ISO calibration		DAkks-Kalibrierung DAkks calibration	
			Art.-Nr. Order no.	EUR	Art.-Nr. Order no.	EUR
01 	Messschieber/ Tiefenmessschieber Caliper/depth caliper 	≤200 mm	98-001	8,90	96-001	17,50
		≤500 mm	98-002	23,00	96-002	27,00
		≤1000 mm	98-003	44,50	96-003	49,00
		☞ ≤2000 mm	98-004	79,00	96-004	168,00
		☞ ≤3000 mm	98-005	166,00		
02 	Bügelmessschraube Micrometer *inkl. Einstellmaß incl. setting dimension 	≤25 mm	98-021	14,80	96-021	27,50
		≤100 mm	98-022*	24,80	96-022*	59,00
		≤500 mm	98-023*	63,00	96-023*	104,00
		☞ ≤1000 mm	98-024*	92,00		
	Gewinde-Bügelmessschraube Screw micrometer ohne Einstellmaß without setting dimension 	≤25 mm	98-033	27,50	96-033	29,50
		≤100 mm	98-034	34,50	96-034	42,50
		≤200 mm	98-035	59,50	96-035	63,00
	Gewinde-Einsätze Thread inserts 	pro Paar each pair	98-037	37,50	96-037	42,50
	Bügelmessschraube Feinzeiger Indicating snap micrometer *inkl. Einstellmaß incl. setting dimension 	≤25 mm	98-025	27,50	96-025	29,50
		≤100 mm	98-026*	39,50	96-026*	62,50
	Bügelmessschraube mit auswechselbaren Ambossen Micrometer with changable anvils ohne Einstellmaße without setting dimensions 	0-100 mm	98-071	67,50		
		0-150 mm	98-072	72,00		
		100-200 mm	98-073	99,00		
		150-300 mm	98-074	146,00		
		200-300 mm	98-075	114,00		



Zubehör, Kalibrierung, allgemeine Informationen Accessories, calibration, general information

Kalibrierung (Fortsetzung) Calibration (continuation)

Kapitel chapter	Messmittel measuring tool	Messbereich/Typ Range/type	ISO-Kalibrierung ISO calibration		DAkkS- Kalibrierung DAkkS calibration	
			Art.-Nr. Order no.	EUR	Art.-Nr. Order no.	EUR
	 Tiefenmessschraube Depth micrometer	≤100 mm	98-078	17,50	96-078	19,50
		≤200 mm	98-079	19,50	96-079	31,50
		≤300 mm				
	 Einstellmaß Setting dimension	≤100 mm	98-028	9,80	96-028	34,50
		≤200 mm	98-029	12,80	96-029	45,00
		≤300 mm	98-030	17,80	96-030	46,50
		≤500 mm	98-031	34,50	96-031	57,50
	 Einstellmaß 60°/55° Setting dimension 60°/55°	≤100 mm	98-191	31,50		
		≤200 mm	98-192	42,50		
03	 Messuhren analog/digital Dial gauges analog/digital	≤10 mm	98-042	15,50	96-042	24,00
		≤30 mm	98-043	19,50	96-043	28,50
		≤100 mm	98-044	28,00	96-044	36,50
	 Fühlhebelmessgerät Dial test indicator	alle all	98-051	19,80	96-051	49,00
	 Dickmessgerät Thickness gauge	≤10 mm	98-081	24,90	96-081	63,50
		≤50 mm	98-082	42,00	96-082	63,50
	 Schnellmesstaster Caliper gauge	alle all	98-058	21,00	96-058	27,50
04	 Innenmessschraube Schnäbel Inside micrometer with jaws *ohne Einstellring without setting ring	≤50 mm	98-069*	29,00	96-069*	59,50
		≤200 mm	98-070*	33,00	96-070*	79,00
	 Zylindr. Innenmessschraube Cylindric inside micrometer	≤200 mm	98-067	26,50	96-067	35,00
		≤500 mm	98-068	32,50	96-068	59,50
	 Verlängerung für zylindr. Innenmessschraube Extension for cylindric inside micrometer	≤100 mm	98-117	17,90		
		≤1200 mm	98-118	44,50		





Zubehör, Kalibrierung, allgemeine Informationen Accessories, calibration, general information

Kalibrierung (Fortsetzung) Calibration (continuation)

Kapitel chapter	Messmittel measuring tool	Messbereich/Typ Range/type	ISO-Kalibrierung ISO calibration		DAkkS- Kalibrierung DAkkS calibration	
			Art.-Nr. Order no.	EUR	Art.-Nr. Order no.	EUR
04 	Innenfeinmessgerät <i>Internal measuring instrument</i> *Gerät mit verlängertem Messber. <i>with extended measuring range</i>	≤160 mm	98-091	31,80	96-091	38,50
		≤300 mm	98-092	36,50		
		≤450 mm	98-093	43,40		
		verlängerter Messbereich*	98-095*	70,50		
		Set 18-160 mm	98-096	72,00		
	3-Punkt-Innenmessschraube <i>3-point internal micrometer</i> *ohne Einstellring <i>without setting ring</i>	≤50 mm	98-061*	19,80	96-061*	35,00
		≤100 mm	98-062*	22,50	96-062*	37,50
		≤200 mm	98-063*	28,00	96-063*	39,50
		≤500 mm	98-064*	84,00		
	Einstellmaß Innenmessschr. <i>Setting dimension inside micr.</i>	≤200 mm	98-065	16,50		
05 	Höhenmessgerät <i>Height gauge</i>	≤300 mm	98-008	26,50	96-008	34,50
		≤600 mm	98-009	34,80	96-009	43,50
		≤1000 mm	98-010	62,50	96-010	68,00
	Zentrierwinkel <i>Centering angle</i>	≤300 mm	98-188	46,50	96-188	52,50
≤600 mm		98-189	56,50	96-189	59,50	
	Streichmaß <i>Marking gauge</i>	≤300 mm	98-190	21,80	96-190	34,50
	Lineal/Maßstab <i>Ruler</i> Preis pro Skala <i>each scale</i>	≤500 mm	98-011	14,50	96-011	47,00
		≤1000 mm	98-012	39,00	96-012	56,50
		≤2000 mm	98-013	74,00	96-013	94,00
	Präzisions-Stahllineal DIN 866 <i>Precision steel ruler DIN 866</i>	≤500 mm	98-017	59,00	96-017	63,00
		≤1000 mm	98-018	79,00	96-018	83,00
		☒ ≤2000 mm	98-019	95,00	96-019	99,00
		☒ ≤3000 mm	98-020	108,00	96-020	112,00
	Maßband (analog/digital) <i>Measuring tape (analog/digital)</i>	≤5 m	98-243	29,50	96-243	57,00
		≤20 m			96-244	138,00
		≤50 m			96-245	337,00

Zubehör, Kalibrierung, allgemeine Informationen Accessories, calibration, general information

Kalibrierung (Fortsetzung) Calibration (continuation)

Kapitel chapter	Messmittel measuring tool	Messbereich/Typ Range/type	ISO-Kalibrierung ISO calibration		DAKKS- Kalibrierung DAKKS calibration	
			Art.-Nr. Order no.	EUR	Art.-Nr. Order no.	EUR
06 	Haarlineal Straight edges 	≤200 mm	98-181	17,00	96-181	34,50
		≤500 mm	98-182	21,50	96-182	49,00
		≤1000 mm	98-183	49,00		
	Haarwinkel Knife edge squares 	≤100x70 mm	98-185	16,80	96-185	32,50
		≤300x200 mm	98-186	19,60	96-186	36,50
	Stahlwinkel 90° Squares 90° 	≤100x70 mm	98-161	16,80	96-161	32,50
		≤300x200 mm	98-162	19,60	96-162	36,50
		≤500x330 mm	98-163	27,50	96-163	39,00
		≤1000x660 mm	98-164	46,00		
	Hartgesteinswinkel Hard stone squares 	≤400x250 mm	98-167	84,50	96-167	269,00
		 ≤1000x630 mm	98-168	114,00	96-168	431,00
	Winkelmesser Protractor 	analog/digital	98-171	24,80	96-171	44,50
	Zusätzliche Schienen Additional blades 	je zusätzlicher Schiene each additional blade			96-173	24,50
	Neigungsmessgerät Inclinometer 	alle all	98-175	52,50	96-175	91,50
	Richtwaage Spirit level 	0,3 mm/m	98-177	62,50	96-177	67,50
		0,1 mm/m	98-178	72,50	96-178	78,50
		0,02 mm/m	98-179	89,00	96-179	96,00
07 	Parallelendmaß Gauge block 	≤100 mm	98-141	8,90	96-141	18,50
		≤200 mm	98-142	39,00	96-142	79,00
		≤300 mm	98-143	42,50	96-143	82,50
		≤400 mm	98-144	47,50	96-144	88,00
		≤500 mm	98-145	47,50	96-145	88,00
		≤700 mm	98-146	74,50	96-146	106,00
		≤1000 mm	98-147	79,00	96-147	113,00
	Parallelendmaß-Satz Gauge block set 	ab 32 Stk. (≤100 mm) from 32 pcs. (≤100 mm)	98-151*	5,85	96-151*	8,75
		Satz 8tlg. (125-500 mm) Set of 8 pcs. (125-500 mm)	98-150	336,00	96-150	645,00

01

02

03

04

05

06

07

08

09

10

11

12

13

14

15









Zubehör, Kalibrierung, allgemeine Informationen Accessories, calibration, general information

Kalibrierung (Fortsetzung) Calibration (continuation)

Kapitel chapter	Messmittel measuring tool	Messbereich/Typ Range/type	ISO-Kalibrierung ISO calibration		DAKKS- Kalibrierung DAKKS calibration	
			Art.-Nr. Order no.	EUR	Art.-Nr. Order no.	EUR
07 	Einstellmeister für Messschieber Setting master for calipers 	alle <i>all.</i>	98-201	49,00	96-201	122,00
	Prüfsatz für Messschieber Gauge block set for calibration of calipers 	5tlg. 5 pcs.	98-202	93,00	96-202	190,00
		6tlg. 6 pcs.	98-203	159,00	96-203	329,00
	Prüfsatz für Bügelmessschrauben Gauge block set for calibration of micrometers ohne Planglas without planar glass 	ab 5 Endmaße (Preis je Stk.) from 5 gauge blocks (price apiece)	98-211	6,80	96-211	9,50
	Planglas (Ebenheit+Parallelität) Planar glass (flatness+parallelism) 	≤Ø60 mm	98-149	64,00	96-149	136,00
	Winkel-Endmaß-Satz Angle gauge block set 	12tlg. 12 pcs.	98-159	178,00		
	Prüfstift Pin gauge 	≤Ø10 mm	98-227	4,90	96-227	7,50
		≤Ø20 mm	98-228	6,50	96-228	9,50
		≤Ø30 mm	98-229	17,00	96-229	24,50
	Prüfstift-Satz Pin gauge set Preise je Prüfstift Prices apiece 	ab 20 Stück <i>from 20 pcs.</i>	98-231	4,00	96-231	6,50
		ab 50 Stück <i>from 50 pcs.</i>	98-232	3,60	96-232	5,40
		ab 100 Stück <i>from 100 pcs.</i>	98-233	2,95	96-233	4,85
	Messkugel Measuring ball 	je Stück <i>each ball</i>	98-241	9,00		
08 	Grenzlehrdorn Plug gauge 	≤Ø12 mm	98-100	9,50	96-100	14,80
		≤Ø50 mm	98-101	11,80	96-101	16,80
		≤Ø100 mm	98-102	16,50	96-102	23,50
		≤Ø250 mm	98-103	24,50	96-103	32,50

Zubehör, Kalibrierung, allgemeine Informationen Accessories, calibration, general information

Kalibrierung (Fortsetzung) Calibration (continuation)

Kapitel chapter	Messmittel measuring tool	Messbereich/Typ Range/type	ISO-Kalibrierung ISO calibration		DAKKS- Kalibrierung DAKKS calibration	
			Art.-Nr. Order no.	EUR	Art.-Nr. Order no.	EUR
Nutenlehre Keyway limit gauge		≤30 mm	98-108	9,50	96-108	28,50
		≤50 mm	98-109	11,80	96-109	34,50
Einstellung Setting ring		≤Ø3 mm	98-110	19,50	96-110	62,50
		≤Ø10 mm	98-111	19,50	96-111	34,50
		≤Ø50 mm	98-112	17,80	96-112	34,50
		≤Ø100 mm	98-113	19,50	96-113	39,00
		≤Ø200 mm	98-114	24,50	96-114	69,50
		≤Ø250 mm	98-115	32,50	96-115	79,50
		≤Ø350 mm				
Grenzrachenlehre Caliper gauge		≤50 mm	98-105	15,80	96-105	21,80
		≤100 mm	98-106	18,50	96-106	23,80
Gewindelehrdorn Thread plug gauge *nur Gut- oder Ausschusdorn only GO or NOGO plug gauge		≤Ø3 mm	98-120	19,50	96-120	22,50
		≤Ø62 mm	98-121	17,50	96-121	21,00
		≤Ø100 mm	98-124*	15,50	96-124*	22,50
		≤Ø200 mm	98-125*	36,50	96-125*	43,50
		≤Ø300 mm	98-126*	72,00	96-126*	89,00
		kegelig conical ≤2" / ≤50mm	98-122	47,50	96-122	57,50
		kegelig conical ≤4" / ≤100mm	98-123	62,00	96-123	72,00
Gewindelehring Thread ring gauge		≤Ø3 mm	98-130	19,50	96-130	26,50
		≤Ø100 mm	98-131	17,50	96-131	31,50
		≤Ø200 mm	98-135	23,00	96-135	46,50
		kegelig conical ≤2" / ≤50mm	98-132	52,50	96-132	59,50
		kegelig conical ≤4" / ≤100mm	98-133	66,50	96-133	74,50
Fühlerlehren-Satz Feeler gauge set		pro Blatt per blade	98-198	1,85	96-198	3,00
Fühlerlehre-Einzelblatt Feeler gauge single leaf		≤2 mm	98-194	5,90	96-194	14,50
Radiuslehre Radius gauge		pro Blatt per blade	98-199	2,20	96-199	3,70

01

02

03

04

05

06

07

08

09

10

11

12

13

14

15

Zubehör, Kalibrierung, allgemeine Informationen

Accessories, calibration, general information

Kalibrierung (Fortsetzung) Calibration (continuation)

Kapitel chapter	Messmittel measuring tool	Messbereich/Typ Range/type	ISO-Kalibrierung ISO calibration		DAKS- Kalibrierung DAKS calibration	
			Art.-Nr. Order no.	EUR	Art.-Nr. Order no.	EUR
08 	Digital-Radiusmessgerät <i>Radius gauge</i>	 alle <i>all</i>	98-197	59,00		
09 	3D-Taster <i>3D-sensor</i>	 analog/digital	98-261	96,00		
10 	Messplatte (Ebenheit) <i>Measuring plate (flatness)</i> Hartgestein oder Guss <i>hard stone or cast iron</i>	≤400 mm	98-085	185,00	96-085	245,00
		 ≤800 mm	98-087	238,00	96-087	252,00
		 ≤1000 mm	98-088	268,00	96-088	275,00
		 ≤1200 mm	98-089	297,00	96-089	315,00
	Prisma <i>Prism</i> Preis je Stk. / Paare 2facher Preis <i>Price apiece / Pairs double price</i>	 ≤200 mm	98-195	73,00		
	Sinuslineal <i>Sine bar</i>	 alle <i>all</i>	98-196	78,00		
11 	Messzeugsatz <i>Measuring tool set</i>	 Bitte Kalibrierung für die einzelnen Messgeräte bestellen! <i>Please order calibration of each measuring tool!</i>				
12 	Messlupe <i>Measuring loupe</i>	 pro Skala <i>per scale</i>	98-251	49,00		
	Messmikroskop <i>Measuring microscope</i>	 Fragen Sie nach einem individuellen Angebot! <i>Please ask for an individual offer!</i>				
13 	Profilprojektor <i>Profile projector</i>	 Fragen Sie nach einem individuellen Angebot! <i>Please ask for an individual offer!</i>				

Zubehör, Kalibrierung, allgemeine Informationen Accessories, calibration, general information

Kalibrierung (Fortsetzung) Calibration (continuation)

Kapitel chapter	Messmittel measuring tool	Messbereich/Typ Range/type	ISO-Kalibrierung ISO calibration		DAKKS- Kalibrierung DAKKS calibration	
			Art.-Nr. Order no.	EUR	Art.-Nr. Order no.	EUR
14 	Waage <i>Scales</i> 	≤5 kg			96-281	77,00
		≤50 kg			96-282	93,00
		≤120 kg			96-283	114,00
	Prüfgewicht <i>Test Weights</i> 	≤500 mg			96-285	15,00
		≤500 g			96-286	16,00
		≤10 kg			96-287	17,00
	Schichtdickenmessgerät <i>Coating thickness gauge</i> inkl. Kalibrierfolie <i>incl. calibration foil</i> 	alle <i>all</i>	98-271	173,00		
	Rauheitsmessgerät <i>Roughness Tester</i> 	alle <i>all</i>	98-275	181,00		
	Rauheitsvergleichsplatte <i>Roughness surface checking plate</i> 	pro Platte <i>per plate</i>	98-276	34,50		
	Härtemessgerät <i>Hardness tester</i> 	Shore A/D	98-265	86,00		
	Härtevergleichsplatten Shore <i>Shore hardness comparison plates</i> 	Set bis 7 Platten <i>Set up to 7 plates</i>	98-267	95,00		
	Härte-Prüfblock <i>Hardness test block</i> 	530-790 HL	98-269	119,00		

01

02

03

04

05

06

07

08

09

10

11

12







13

14

15

Zubehör, Kalibrierung, allgemeine Informationen Accessories, calibration, general information

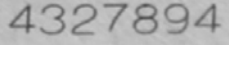
Kalibrierung (Fortsetzung) Calibration (continuation)

Kapitel chapter	Messmittel measuring tool	Messbereich/Typ Range/type	ISO-Kalibrierung ISO calibration		DAKKS- Kalibrierung DAKKS calibration	
			Art.-Nr. Order no.	EUR	Art.-Nr. Order no.	EUR
14 	Kraftmessgerät Force gauge 	Zugkraft <i>pull force</i> ≤500 N	98-301	133,00	96-301	133,00
		≤2000 N	98-302	162,00	96-302	162,00
		≤5000 N	98-303	221,00	96-303	221,00
		Druckkraft <i>push force</i> ≤500 N	98-304	133,00	96-304	133,00
		≤2000 N	98-305	162,00	96-305	162,00
		≤5000 N	98-306	221,00	96-306	221,00
		Zug und Druck <i>Pull and push</i> ≤500 N	98-307	239,00	96-307	239,00
		≤2000 N	98-308	294,00	96-308	294,00
		≤5000 N	98-309	397,00	96-309	397,00
	Drehmomentmessgerät Torque meter 	5-1000 Nm	98-321	169,00		
	Lichtmessgerät Light measuring instrument 	≤200.000 lx	98-351	162,00		
15 	Gravur Alphanumerisch Engraving alphanumeric 	max. 10stellig <i>max. 10 digits</i>	98-291	4,80		
	Gravur 2D-Code Engraving 2D code 	DataMatrix-Code/QR-Code	98-292	4,80		

Stichwortverzeichnis

Anbaumessschieber	01.36	Fadenzähler	12.5	Kabel	15.2
Anbaumessschrauben (analog)	02.12	Fasennmessgeräte	08.38	KÄFER Dicken-Messgeräte	03.21
Anbaumessschrauben (digital)	02.20	Feinmesstische	10.5	KÄFER Fühlhebelmessgeräte	03.19
Anreiß-Messschieber	05.5	Feinzeiger-Bügelmessschraube	02.5	KÄFER Messuhren	03.3
Anreißwerkzeuge	05.1	Feuchtebestimmer	14.5	Kalibrierung	15.8
Anschlagwinkel	06.2	Filetor	15.6	Kalibrier-Set für Bügelmessschrauben	07.8
Arbeitsleuchten	12.8	FISSO Magnet-Messstative	10.15	Kalibrier-Set für Messschieber	07.8
Arbeitslupen	12.8	Fixierhalter	10.2	Kameras	12.23
Aufkleber	15.7	Flachwinkel	06.2	Kantentaster	09.2
Außeneinstich-Messgerät	03.31	Flanschenwinkel	06.2	Keilnutenmessschieber	01.35
Außen-Schnellmesstaster	03.24	Foliendicke-Messgerät	03.23	KERN Waagen	14.2
		Fräser-Anreißnadel	05.10	Kernloch-Lehren	08.24
B andmaß	05.15	Fühlhebelmessgeräte	03.18	Kleinmesstisch	10.3
Batterien	15.4	Fühlerlehren	08.33	Komparator	03.3
BENZING Messtische	10.3	Funk-Bügelmessschraube	02.15	Kontrollplatten	10.7
Bluetooth®-Dongle	15.4	Funk-Messschieber	01.15	Koordinatenmessdorne	08.16
Bogenzirkel	05.8	Funk-Messuhren	03.14	Körner	05.10
Bohrer-Schleiflehre	08.39	Fußtaster	15.3	Kraftmessgeräte	14.11
Bohrungsabstand-Messschieber	01.21			KROEPLIN Schnellmesstaster	03.25
Bohrungslehrdorne einstellbar	08.7	G -Gewindelehren	08.28	Kugel-Lehrdorne	07.16
Bohrungslehre	08.36	Gesperrt-Aufkleber	15.7		
BOSS-Gewindelehren	08.15	Gewichte	14.4	L amellen-Magnetfuß	10.13
Brillenlupe	12.5	Gewinde-Lehren	08.12	Laser-Entfernungsmesser	05.14
BSF/BSW-Gewindelehren	08.29	Gewinde-Prüftiftsatz	07.15	Lasertaster	09.4
Bügelmessschrauben	02.2	Gewindedaten-Anzeiger	15.6	Lautstärke-Messgerät	14.16
Bügelmessschrauben (digital)	02.13	Gewindeschablone	08.31	LED-Leuchten	12.8
		Glasmaßstab	05.14	Leichtmetall-Messschieber	01.5
C onvertor	15.6	Gliedermaßstab	05.15	Leiterplattenhalter	10.2
		Gradmesser	06.10	Lehren	08.1
D Akks-Kalibrierung	15.8	Gradscheibe	06.9	Lichtmessgerät	14.16
Datenübertragungskabel	15.2	Granitplatten	10.7	Limit-Bügelmessschraube	02.5
Dicken-Messgeräte	03.21	Gravur	15.16	Lineale	05.11
Digital-Mikroskop	12.15	Grenzlehrdorne	08.2	Linkshänder-Bügelmessschraube	02.3
DINO-LITE Digital-Mikroskope	12.13	Grenzzachenlehren	08.8	Linkshänder-Messschieber	01.13
Draht-Messschraube	02.9	Grenzwellennutenlehren	08.32	Lochlehren	08.36
Drehmomentmessgeräte	14.12			Lupen	12.2
Drehzahlmessgerät	14.16	H aarlineale	06.8		
Drei-Punkt-Innenmessschraube	04.8	Haarwinkel	06.7	M agnet-Messstative	10.11
Drei-Punkt-Innenmessschraube (digital)	04.9	HAIMER Universal-3D-Taster	09.8	Magnet-Mess- und Spannprismen	10.19
Durometer	14.9	Halter für Bügelmessschrauben	02.6	Maschinen-Richtwaage	06.15
Düsenlehren	08.36	Härtemessgeräte	14.8	Maßband	05.15
		Härte-Prüfblock	14.10	Maßstäbe	05.11
E benheitsprüfung	07.9	Härte-Vergleichsplatten	14.8	Materialdicken-Messgerät	14.6
EG-Gewindelehren	08.24	Hartgesteinsplatten	10.7	Mehrfach-Winkel	06.5
Einbaumessschieber	01.36	Helicoil-Gewindelehren	08.24	Messbrücke für Tiefenmessschieber	01.35
Einbaumessschrauben (analog)	02.12	HELIOS-PREISSER Bügelmessschrauben	02.2	Messeinsätze für Bügelmessschrauben	02.11
Einbaumessschrauben (digital)	02.20	HELIOS-PREISSER Grenzlehrdorne	08.3	Messeinsätze für Messschieber	01.23
Einbau-Messstative	10.6	HELIOS-PREISSER Messschieber	01.3	Messkeil	08.32
Einhand-Tiefenmessschieber	01.33	HELIOS-PREISSER Messuhren	03.13	Messkugeln	07.16
Einsätze für Bügelmessschraube	02.11	HELIOS-PREISSER Stahlwinkel	06.3	Messlupen	12.5
Einsätze für Messuhr	03.8	HELIOS-PR. 3-Punkt-Innenmessschraube	04.10	Messmikroskope	12.16
Einstellgeräte Z-Achse	09.5	Höhenreißer	05.2	Messplatten	10.7
Einstellmaße für Bügelmessschraube	02.18			Messprojektor (automatisch)	13.5
Einstellmaße für Gewindemessung	02.18	I nfrarot-Thermometer	14.15	Messschieber	01.1
Einstellmaße für Innenmessschrauben	04.5	Inneneinstich-Messgerät	03.31	Messschieber (digital)	01.11
Einstellmeister für Messschieber	07.8	Innen-Feinmessgerät	04.5	Messschieber (Leichtmetall)	01.5
Einstellringe	08.9	Innen-Messgeräte	04.1	Messschrauben	02.1
Einstich-Messgeräte	03.31	Innenmessschrauben	04.2	Messstative	10.6
Endmaße	07.2	Innen-Schnellmesstaster	03.24	Messstifte	07.10
Endmaß-Halter	07.5	Innenwinkel-Gradmesser	06.11	Messstifthalter	07.13
Endskope	12.9			Messtische	10.4
Entfernungsmesser	05.16	J BO-Gewindelehren	8.15	Messuhreinsätze	03.8
ESCHENBACH Lupen	12.3			Messuhren	03.1

01

02

03

04

05

06

07

08

09

10

11

12

13

14

15

Zubehör, Kalibrierung, allgemeine Informationen

Accessories, calibration, general information

Stichwortverzeichnis (Fortsetzung)

Messuhren (digital)	03.11	Sägeschränkmessuhr	03.23	Vakuum-Messstativ	10.12
Messuhrverlängerungen	03.9	SAUTER-Messgeräte	14.6	Vergleichsmessgerät	03.32
Messzeug-Sätze	11.1	SCALA Messschieber	01.5	Verlängerungen für Messuhren	03.9
Meterstab	05.15	Schallpegelmessgeräte	14.16	Video-Software	12.24
Mikroskope	12.10	Schichtdickenmessgeräte	14.5	VOGEL Maßstäbe	05.11
MultiCheck-Gewindelehren	08.17	Schieblehren	01.1	Vorsatzlinsen	12.19
MultiCheck-Grenzlehrdorne	08.7	Schlosserwinkel	06.2		
		Schmiege	06.9		
Neigungsmessgeräte	06.14	Schnellmesstaster	03.24	Waagen	14.2
NIIGATA Einstellringe	08.10	Schnittmacherwinkel	06.7	Wanddicken-Messgerät	03.22
NIKON Mikroskope	12.12	Schraubstöcke	10.16	Wanddicken-Messschraube	02.10
NIKON Profilprojektor	13.4	Schwanenhals-Beleuchtung	12.21	Wasserwaagen	06.15
NPT/NPTF-Gewindelehren	08.30	Schweißnahtlehren	08.38	Werkstattlineale	05.13
Nulleinstellgeräte	09.5	Schwenkprisma	10.22	Werkstattmessschieber (analog)	01.4
Nuten-Bügelmessschraube	02.8	Shore-Härtenmessgerät	14.8	Werkstattmessschieber (digital)	01.26
Nuten-Bügelmessschraube (digital)	02.17	Sinuslineale	10.22	Whitworth-Gewindelehren	08.28
Nutenlehren	08.32	Sinus-Schraubstöcke	10.17	Winkel	06.1
Nuten-Messschieber	01.6	Spannbügel für Messuhr	09.7	Winkel-Endmaße	07.7
Nuten-Messschieber (digital)	01.19	Spiegel	12.2	Winkelköpfe für Messuhren	03.9
		Spiralbohrer-Schleiflehre	08.39	Winkellehren	08.38
OEI Messplatten	10.8	Stabmikroskop	12.7	Winkelmesser	06.10
Okular-Kamera	12.10	Stahlwinkel	06.2	Winkelskala	06.9
		Stand-Lupe	12.4		
Papierdicke-Messgerät	03.23	Stangenzirkel	05.8	Z-Achsen-Einstellgerät	09.5
Parallelendmaße	07.2	Stative	10.11	Zahnweiten-Messschieber	01.6
Parallelunterlagen	10.20	Stellwinkel	06.9	Zahnweiten-Messschieber (digital)	01.22
Passungsdaten-Anzeiger	15.6	Stereo-Mikroskope	12.10	Zentriergeräte	09.7
Pflege-Set für Endmaße	07.7	Stiftmikroskope	12.7	Zentrierwinkel	05.7
Pg-Gewindelehren	08.30	Stoppuhr	14.15	Zirkel	05.8
Pistolen-Innenmessgeräte	04.12	Streichmaß	05.6	Zirkel-Messschieber	05.8
Plangläser	07.9	SYLVAC Bügelmessschrauben	02.16	Zollstock	05.15
PMÜ-Aufkleber	15.7	SYLVAC Höhenmessgerät (motorisch)	05.5	Zylindrische Innenmessschrauben	04.3
Positioniertische	12.23	SYLVAC Messschieber	01.16		
Präzisionskugeln	07.16	SYLVAC Messuhren (digital)	03.15	120°-Winkel	06.5
Prismen	10.18			135°-Winkel	06.5
Profilprojektoren	13.1	Teller-Bügelmessschraube (analog)	02.9		
Prüfgewichte	14.4	Teller-Bügelmessschraube (digital)	02.17	3D-Taster	09.8
Prüfplaketten	15.7	Thermometer	14.14	3-Punkt-Innenmessschraube	04.8
Prüfplatte	10.7	Tiefenmessbrücke für Messschieber	01.7	3-Punkt-Innenmessschraube (digital)	04.9
Prüfsatz für Bügelmessschrauben	07.8	Tiefenmessbrücke für Messuhren	03.10	3-Punkt-Innen-Schnellmesstaster	03.30
Prüfsatz für Messschieber	07.8	Tiefenmessschieber (analog)	01.8	3-Punkt-Messschieber	01.22
Prüfstifte	07.10	Tiefenmessschieber (digital)	01.31		
Prüfstifthalter	07.13	Tiefenmessschraube (analog)	02.12	45°-Winkel	06.5
		Tiefenmessschraube (digital)	02.21		
QM-Aufkleber	15.7	Toleranzmarkierung-Aufkleber	03.10	5-Punkt-Messschieber	01.22
Quernuten-Messschraube	04.3	Tolerator	15.6		
		Tr-Gewindelehren	08.31	60°-Winkel	06.5
R/Rp/Rc-Gewindelehren	08.29	TSCHORN Kantentaster	09.2		
Rachenlehren	08.8	TSCHORN Nulleinstellgeräte	09.6	90°-Winkel	06.2
Radialkörner	06.14	TSCHORN 3D-Taster	09.9		
Radiuslehren	08.37				
Radius-Messschieber	01.22	Uhrenmessschieber	01.4		
Rahmen-Richtwaage	06.15	UHRFAST-Vergleichsmessgerät	03.32		
Ratschen-Kraftmessgerät	02.5	Umrechnungsanzeiger	15.6		
Rauheitsmessgerät	14.7	UN-Gewindelehren	08.26		
Rauheits-Vergleichsplatten	14.7	UNC/UNF/UNEF-Gewindelehren	08.25		
Reinigungsmittel	15.5	Universal-Halter	10.2		
Reißnadeln	05.9	Universal-Messschieber-System	01.23		
Richtwaage	06.15	Universal-Vergleichsmessgerät	03.32		
Ringlichter	12.21	UNJC/UNJF-Gewindelehren	08.27		
Rissbreite-Lehre	08.34	Untersuchungsspiegel	12.2		
Rundlaufprüfgeräte	03.17	USB-Mikroskope	12.13		

Zubehör, Kalibrierung, allgemeine Informationen

Accessories, calibration, general information

Index

Ancillary lens	12.19	ESCHENBACH loupe	12.3	JBO thread gauges	08.15
Angle gauge	08.38	Extension rods for dial gauges	03.9	Jet gauge	08.36
Angle gauge blocks	07.7	Eyeglasses loupe	12.5		
Angle scale	06.9	Eyepiece camera	12.10	KÄFER dial gauges	03.3
				KÄFER thickness gauge	03.21
Ball plug gauges	07.16	Feeler gauge	08.33	KERN scales	14.2
Batteries	15.4	Filetor	15.6	Keyway gauge	08.32
Beam compass	05.8	FISSO magnetic measuring stand	10.15	Knife edge square	06.7
Bench center	03.17	Fixation holder	10.2	KROEPLIN caliper gauges	03.25
Bench vice	10.16	Flange squares	06.2		
BENZING measuring table	10.3	Folding meter	05.15	Labels	15.7
Bevel	06.9	Foil thickness gauge	03.23	Lamellar magnetic base	10.13
Bluetooth® dongle	15.4	Foot switch	15.3	Laser distance meter	05.14
BOSS thread gauges	08.15	Force gauge	14.11	Laser probe	09.4
BSW/BSF thread gauges	08.29	Frame spirit level	06.15	LED lamp	12.8
Bubble level	06.15			Left-hander calipers	01.13
		G thread gauges	08.28	Left-hander micrometer	02.3
Cables	15.2	Gauges	08.1	Light measuring instrument	14.16
Calibration	15.8	Gauge blocks	07.2	Light metal caliper	01.5
Caliper	01.1	Gauge block holder	07.5	Limit mark sticker	03.10
Caliper (digital)	01.11	Gauge block sets	07.6	Limit micrometer	02.5
Caliper (light metal)	01.5	Gauge block set for calibration calipers	07.8	Limit plug gauge	08.2
Caliper gauges	03.24	Gauge block set for calibration microm.	07.8	Loupe	12.2
Camera	12.23	Glass scale	05.14		
Centering angle	05.7	Granite plate	10.7	Magnetic measuring stand	10.11
Centre indicator	09.7	Grey cast iron plate	10.10	Magnetic V-block	10.19
Centre punch	05.10	Groove calipers	01.6	Magnifying lamp	12.8
Chamfer measuring tool	08.38	Groove calipers (digital)	01.19	Maintenance set for gauge blocks	07.7
Clamping bracket for dial gauge	09.7	Groove micrometers	02.8	Marking caliper	05.5
Cleaning compound	15.5	Groove micrometers (digital)	02.17	Marking gauges	05.1
Coating thickness gauge	14.5			Material thickness gauge	14.6
Comparative measuring instrument	03.32	HAIMER universal 3D-sensor	09.8	Measuring balls	07.16
Compass vernier caliper	05.8	Hard stone plate	10.7	Measuring loupe	12.5
Convertor	15.6	Hardness comparison plates	14.8	Measuring microscopes	12.16
Coordinate gauge rod	08.16	Hardness test block	14.10	Measuring projector (automatic)	13.5
Core hole plug gauges	08.24	Hardness tester	14.8	Measuring table	10.4
Crack width gauge	08.34	Height gauge	05.2	Measuring tape	05.14
Cross head for dial gauges	03.9	Height gauge (digital)	05.3	Measuring tips for dial gauges	03.8
Cut-in measuring instruments	03.31	Helicoil plug gauges	08.24	Measuring tool sets	11.1
Cylindric inside micrometer	04.3	HELIOS-PREISSER caliper	01.3	Micrometer	02.1
		HELIOS-PREISSER dial gauge	03.13	Micrometer (digital)	02.13
DAkkS calibration	15.8	HELIOS-PREISSER limit plug gauges	08.3	Micrometer heads	02.12
Data transfer cable	15.2	HELIOS-PREISSER micrometer	02.2	Micrometer heads (digital)	02.20
Depth caliper	01.8	HELIOS-PREISSER squares	06.3	Microscopes	12.10
Depth caliper (digital)	01.31	HELIOS-PR. 3-point internal micrometer	04.10	Milling scriber	05.10
Depth measuring base	01.7	Holder for micrometer	02.6	Mirror	12.2
Depth micrometer	02.12	Hole gauge	08.36	Moisture Analyzer	14.5
Depth micrometer (digital)	02.21	Hole gauge adjustable	08.7	MultiCheck limit plug gauge	08.7
Dial caliper	01.4	Hole separation caliper	01.21	MultiCheck thread gauges	08.17
Dial comparator	03.3			Multiple angle square	06.5
Dial gauge	03.1	Inclinometer	06.14		
Dial gauge (digital)	03.11	Indicator thread data	15.6	NIIGATA setting rings	08.10
Dial test indicator	03.18	Indicator tolerance data	15.6	NIKON microscopes	12.12
Digital microscope	12.15	Infrared thermometer	14.15	NIKON profile projector	13.4
DINO-LITE digital microscope	12.13	Inserts for dial gauges	03.8	NPT/NPTF thread gauges	08.30
Distance meter	05.16	Inserts for micrometer	02.11		
Divider	05.8	Inspection mirror	12.2	OELZE hard stone plate	10.8
Drill grinding gauge	08.39	Integration stand	10.6	One-hand operation depth caliper	01.33
		Inside micrometer	04.2		
Edge finder	09.2	Inspection plates	15.7	Paper thickness gauge	03.23
EG thread gauges	08.24	Internal measuring instruments	04.1	Parallel supports	10.20
Endoscope	12.9	Internal micrometer	04.2	Pen microscope	12.7
Engraving	15.16			Pg thread gauges	08.30

01

02

03

04

05

06

07

08

09

10

11

12

13

14

15

Zubehör, Kalibrierung, allgemeine Informationen

Accessories, calibration, general information

Index (continuation)

Pin gauges	07.10	TSCHORN zero setter	09.6		
Pin gauge holder	07.13	TSCHORN 3D-sensor	09.9		
Pin gauge set	07.14	Tube micrometer	02.10		
Pin gauge set for measuring threads	07.15	Twist drill grinding gauge	08.39		
Pistol measuring tools	04.12				
Pivoting prism	10.22	U HRTAST comparison measuring instr.	03.32		
Planar glass	07.9	UN thread gauges	08.26		
Positioning table	12.23	UNC/UNF/UNEF thread gauges	08.25		
Printed circuit board holder	10.2	Universal caliper system	01.23		
Profile projectors	13.1	Universal comparison measuring instr.	03.32		
Protractor	06.10	Universal holder	10.2		
		UNJC/UNJF thread gauges	08.27		
R/Rp/Rc thread gauges	08.29	USB microscopes	12.13		
Radius caliper	01.22				
Radius gauge	08.37	V -blocks	10.18		
Ratchet force measuring tool	14.16	V-head	08.32		
Ring light	12.21	Vacuum base measuring stand	10.12		
Rod microscope	12.7	Vernier caliper	01.2		
Rotation speed counter	14.16	Video software	12.24		
Roughness checking plates	14.7	VOGEL ruler	05.11		
Roughness tester	14.7				
Ruler	05.11	W eights	14.4		
		Welding seam gauge	08.38		
S AUTER measuring devices	14.6	Whitworth thread gauges	08.28		
Saw tooth offset gauge	03.23	Wing divider	05.8		
SCALA calipers	01.5	Wire micrometer	02.9		
Scale unit	01.36	Wireless calipers	01.15		
Scales	14.2	Wireless dial gauges	03.14		
Scribers	05.9	Wireless micrometers	02.15		
Section thickness gauge	03.22	Workshop caliper	01.4		
Setting dimension for micrometer	02.18	Workshop caliper (digital)	01.26		
Setting dimension for inside micromet.	04.5	Working lamp	12.8		
Setting master for calipers	07.8				
Setting ring	08.9	Z -zero setter	09.5		
Shore hardness tester	14.8				
Sine bar	10.22	120° squares	06.5		
Sine vice	10.17	135° squares	06.5		
Small measuring table	10.3				
Sound level meter	14.16	3D -sensor	09.8		
Spirit Level	06.15	3-point calipers	01.22		
Stands	10.11	3-point caliper gauge	03.30		
Stand Loupe	12.4	3-point internal micrometer	04.8		
Stereo microscopes	12.10	3-point internal micrometer (digital)	04.9		
Stop watch	14.15				
Straight edges	06.8	45° squares	06.5		
Squares	06.1				
Swan neck light	12.21	5 -point calipers	01.22		
SYLVAC caliper	01.16				
SYLVAC dial gauges (digital)	03.15	60° squares	06.5		
SYLVAC height gauge (motor-driven)	05.5				
SYLVAC micrometer	02.16	90° squares	06.2		
T est weights	14.4				
Thermometer	14.14				
Thickness gauge	03.21				
Thread gauges	08.12				
Thread master plates	08.31				
Three-point internal micrometer	04.8				
Three-point internal micrometer (digit.)	04.9				
Tolerator	15.6				
Torque meter	14.12				
Tr thread gauges	08.31				
TSCHORN edge finder	09.2				

Absender (Firmenstempel) sender (company stamp)

Kundennummer (falls bekannt) _____
customer ID (if known)

Ansprechpartner/Abteilung _____
contact person/department

interne Bestellnummer _____
internal order no.

Datum/Unterschrift _____
date/signature

Hiermit bestellen wir zu den uns bekannten allgemeinen Geschäftsbedingungen der Fa. Quality-Tools Messtechnik e. K. folgende Artikel:
Hereby we order from Co. Quality-Tools Messtechnik e. K. the following articles and we accept the known general terms and conditions:

Art.-Nr. Order no.	Bezeichnung description	Stk. pcs.	EUR

Bemerkungen (z. B. abweichende Lieferanschrift) remarks (e. g. differing delivery adress)

<p>Verkaufs-, Liefer- und Zahlungsbedingungen Lieferung: nur an gewerbliche Kunden gemäß unseren AGB (herunterladbar auf www.quality-tools.de oder auf Wunsch zugesendet) Preise: Die Katalogpreise sind Festpreise zzgl. MwSt., gültig bis 30.04.2022 Versandkosten: Wir berechnen für Verpackung, Versand und Versicherung eine Pauschale von 5,90 EUR (nach Deutschland oder Österreich). Die Pauschale entfällt ab einem Netto-Bestellwert von 150,00 EUR. Bei Speditionsversand (mit gekennzeichnete Artikel) oder Versand in andere Länder Berechnung der Versandkosten nach Aufwand. Keine Mindestbestellmenge / keine Mindermengenzuschläge! Auf Wunsch Versand per Express möglich! Zahlungsbedingungen: gegen Rechnung (2% Skonto innerhalb 10 Tage / 30 Tage netto) (bonitätsabhängig) Rückgabe: Artikel im Neuzustand (inkl. Original-Verpackung) können innerhalb 8 Tagen zurückgegeben oder umgetauscht werden. Die Ware ist frachtfrei unter Angabe der Lieferschein- oder Rechnungsnummer bei uns anzuliefern. Von der Rückgabe ausgeschlossen sind Sonderanfertigungen (z. B. Artikel mit Abmessungen und/oder Gravur nach Kundenwunsch) sowie kalibrierte Messmittel. Garantie: Entsprechend unseren AGBs leisten wir Garantie für Material- und Herstellungsfehler innerhalb 12 Monaten ab Lieferdatum. Die beanstandete Ware ist frachtfrei bei uns anzuliefern. Bei berechtigter Reklamation erfolgt kostenlose Reparatur oder Ersatzlieferung nach unserer Wahl. Darüberhinausgehende Ansprüche sind ausgeschlossen. Für Messmittel, die nicht von uns kalibriert wurden, übernehmen wir keine Haftung.</p>	<p>Sales terms Delivery: only commercial customers according to our general business and delivery terms (Download from quality-tools.de) Prices: Our prices are fixed prices plus tax, valid until 30/04/2022 Shipping costs: Prices for shipping in foreign countries depend on size, weight and distance and are calculated according to charge of our forwarder! Please ask for further details (heavy/large products)! No minimum order quantities / no extra charge for small quantities! On demand, shipping by express is possible! Payment conditions: on account (credit period 30 days) (depending on credit rating) New foreign customers only payment in advance (bank transfer or Paypal) Return: Products in new condition (incl. original packaging) can be returned or exchanged within 8 days. The products have to be returned free of transportation charges with indication of delivery note ID or invoice ID. Barred from return are custom-made products (e. g. products with dimensions and/or engraving according to customer wishes) and measuring tools with calibration certificate. Warranty: According to our terms and conditions we give warranty adjustments within 12 months since delivery date. The rejected goods have to be returned free of transportation charges. In case of authorized claims it is us to make a choice whether we repair the product for free or you get a replacement delivery. Exceeding demands are excluded. For measuring tools, that aren't calibrated by us, we exclude every liability.</p>
---	--

